

www.myperformanceplus.de

performance
plus

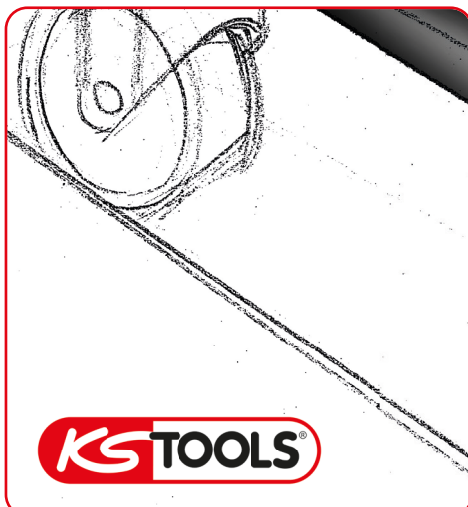
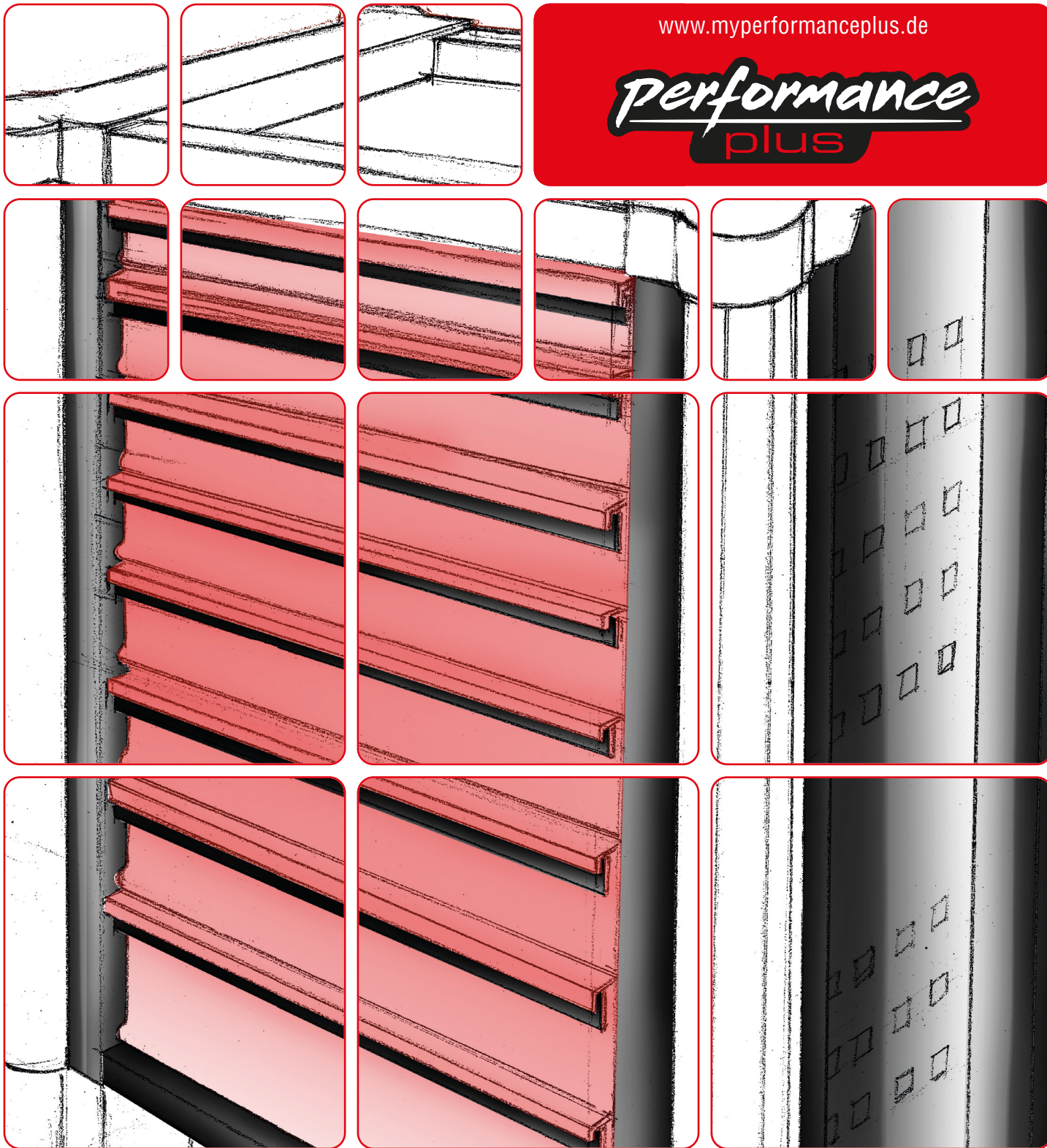

KS TOOLS

ERLEBEN SIE DIE NEUEN
PREMIUM
WERKSTATTWAGEN

WIR WOLLEN DIE PREMIUM-KLASSE DER WERKSTATTWAGEN NEU DEFINIEREN

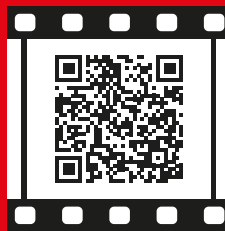
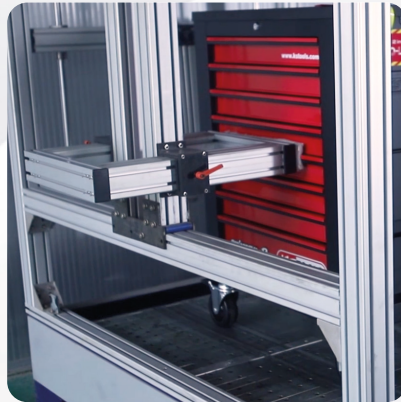
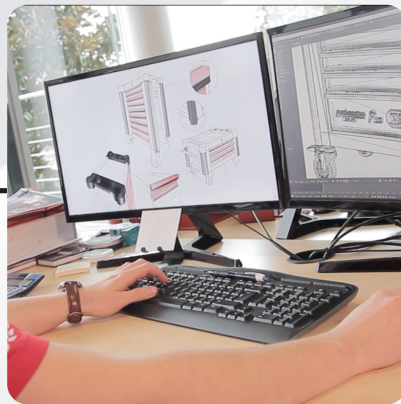

Performance im
bewegten Bild

**Unsere Mission: Der beste Werkstattwagen für
Mechaniker aus Industrie, KFZ und NFZ und
für alle Individualisten mit höchsten Ansprüchen.**

Wir halten mehr als wir versprechen:

**MAXIMALE PERFEKTION
IN DER KONSTRUKTION.**

Höchste Qualität in der Fertigung.

**GRÖSSTE KONSEQUENZ
IN DER PREISGESTALTUNG.**

Keine Kompromisse in der Kontrolle.

**3 JAHRE INTENSIVE
ENTWICKLUNGSSARBEIT.**

KONTROLLE IST GUT. UNSERE KONTROLLE IST BESSER.

Zeitloses Design, exzellente Qualität, perfekte Verarbeitung. Das sind unsere Zutaten für Werkstattwagen für Generationen. Von der ersten Idee bis zur finalen Kontrolle geben wir alles für die bestmögliche Performance.

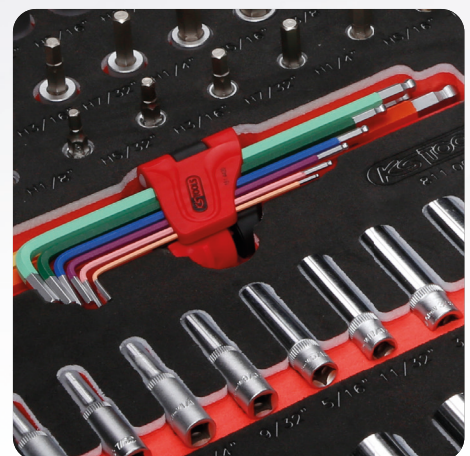
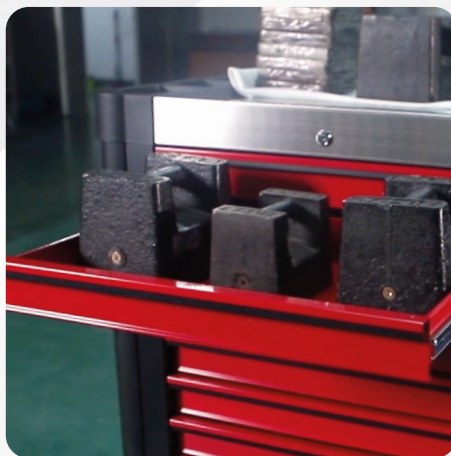

**LANGZEITTESTS
FÜR ALLE ROLLEN**

**30.000-facher Schubladentest
bei maximaler Belastung**

**48 STUNDEN DAUERBELASTUNGS-
TESTS FÜR ALLE BAUTEILE**

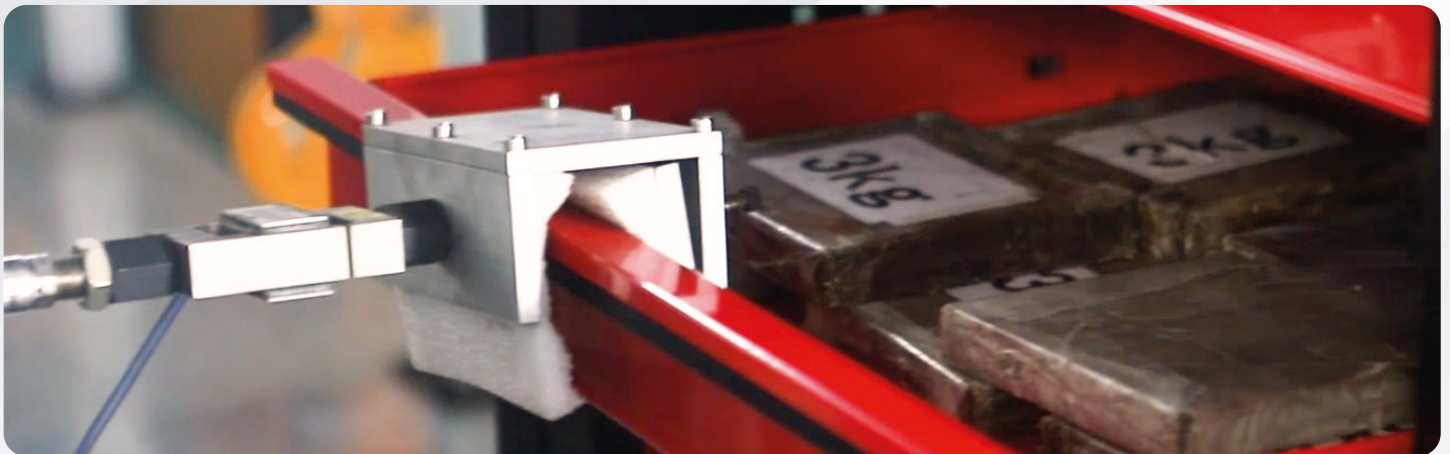

100 % stückgeprüft

**AUSLIEFERUNG
KOMPLETT MONTIERT UND
MIT WERKZEUGEN BESTÜCKT**

WIR BAUEN WERKSTATTWAGEN FÜR GENERATIONEN

Damit die Werkstattwagen von Performance Plus funktionieren, müssen hunderte von Einzelteilen perfekt miteinander harmonieren. Damit Ihr Werkstattwagen auch in vielen Jahren noch so verlässlich funktioniert wie am ersten Tag, garantieren wir Ihnen, dass jede Komponente austauschbar und nachkaufbar ist.

NUR DIE BESTEN WERKZEUGE

Für die Bestückung von Performance Plus kommen natürlich nur die besten Werkzeuge von KS Tools in Frage. Aus unserem riesigen Sortiment mit 45.000

Werkzeugen wählen wir mit unserer jahrzehntelangen Herstellerkompetenz die optimalen für Ihren Anwendungszweck aus.



Ihr Performance Assistant hat den Werkstattwagen Ihrer Träume nicht nur nach Ihren Vorstellungen bestückt und vor der Auslieferung exakt kontrolliert. Er steht Ihnen auch anschließend für alle Fragen rund um Performance Plus zur Verfügung – rund um die Uhr!

WIR NEHMEN SERVICE PERSÖNLICH

DIE GESAMTE PERFORMANCE PLUS FLOTTE.

	P10	P10TC	P15	P20	P25	P30	P35	P40	P45
Maße (B x H x T)	853 x 1024 x 527	853 x 454 x 527	845 x 1023 x 516	1067 x 1023 x 646	1040 x 1024 x 527	1075 x 1024 x 657	1232 x 1027 x 741	1701 x 1017 x 710	1701 x 1132 x 710
Anzahl Schubladen	8	4	8	8	8	8	8	4	14
Schubladenformate	2	1	2	2	2	2	3	2	4
Schubladeninnenmaße	568 x 398 x 65 568 x 398 x 145	568 x 398 x 65	568 x 398 x 65 568 x 398 x 145	785 x 568 x 65 785 x 568 x 145	755 x 398 x 65 755 x 398 x 145	785 x 568 x 65 785 x 568 x 145	268 x 398 x 65 568 x 398 x 65 568 x 398 x 145	1429 x 568 x 180 1429 x 568 x 145	1429 x 568 x 180 568 x 568 x 65 785 x 568 x 65 785 x 568 x 145
max. belastbar mit kg	600 kg	400 kg	600 kg	600 kg	600 kg	600 kg	600 kg	1000 kg	1000 kg
Edelstahl-Arbeitsplatte	•	•	•	•	•	•	•	•	•
Duo-Lock	•	•	•	•	•	•	•	•	•
Abschließbar	1x	1x	1x	1x	1x	1x	2x	1x	1x

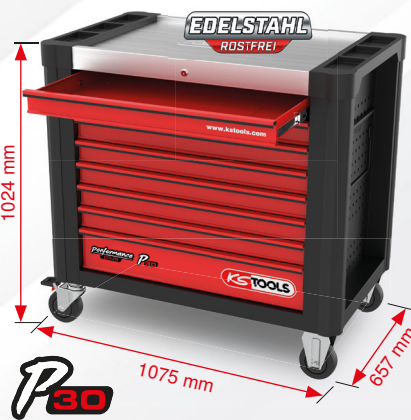

P10

DER KOMPAKTE MIT DER ÜPPIGEN BESTÜCKUNG



2.349,- € 810.7397

inklusive 397 Werkzeuge >>

PERFORMANCE PLUS

MONTIERT UND KOMPLETT KONFEKTIONIERT MIT 397 QUALITÄTSWERKZEUGEN.

1

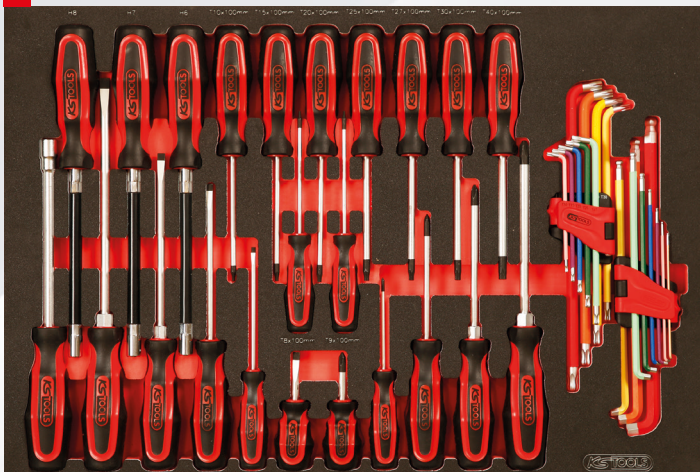

SCS ERGOTORQUEPLUS SCHRAUBENDREHER-SATZ, 41-TLG



2

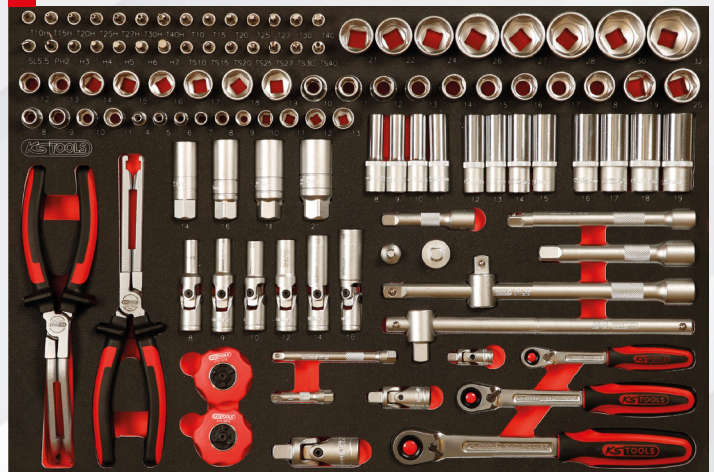

SCS 1/4"+3/8"+1/2" STECKSCHLÜSSEL-SATZ, 111-TLG



5



SCS ZANGEN-SATZ, 23-TLG



6



SCS REIFENDIENST-WERKZEUG-SATZ, 43-TLG



PERFORMANCE

performance
plus

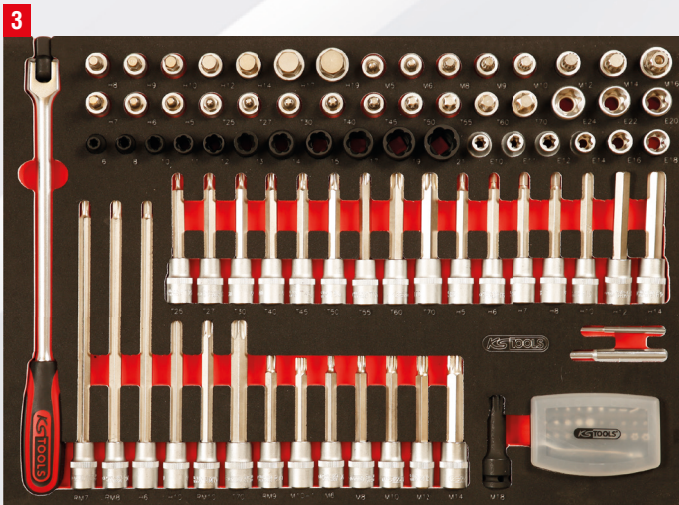

SCS 1/2" STECKSCHLÜSSEL-SATZ, 111-TLG

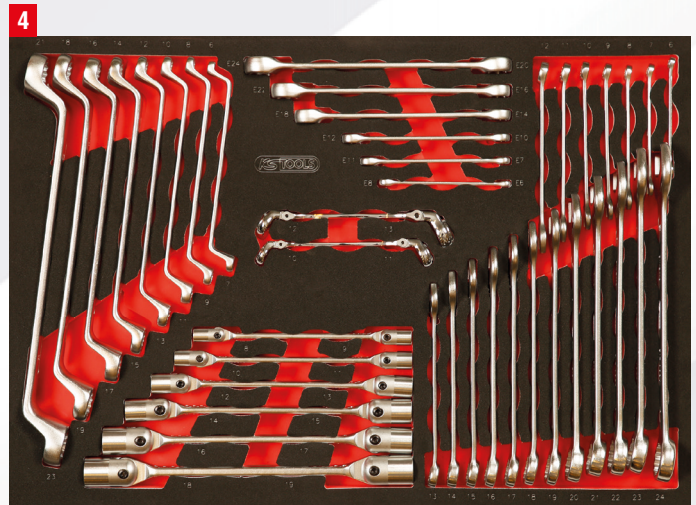

SCS SCHLÜSSEL-SATZ, 41-TLG



SCS MEISSEL- UND HAMMER-SATZ, 22-TLG



ICE IST EINZIGARTIG

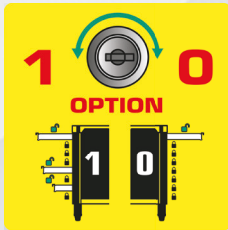

DUO Lock geniale
Verschlussstechnik



8 Schubladen jeweils
bis zu 50 kg belastbar



Stabiles
Kugellager

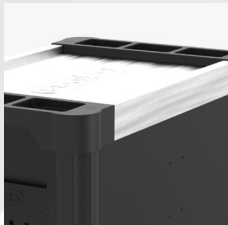

Edelstahloberfläche

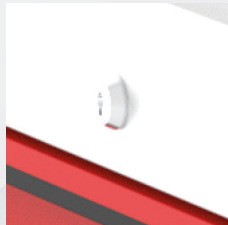

Schloss
abschließbar



Antistatische Rollen
mit Bremse



Integrierter
Kantenschutz



Inklusive
Papierrollenhalter



Inklusive
Dosenhalter



max.
600 kg

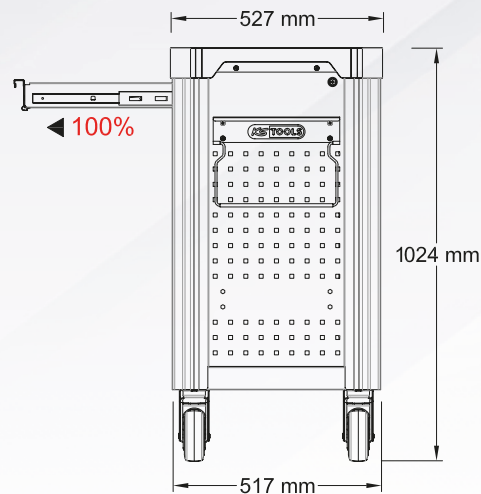
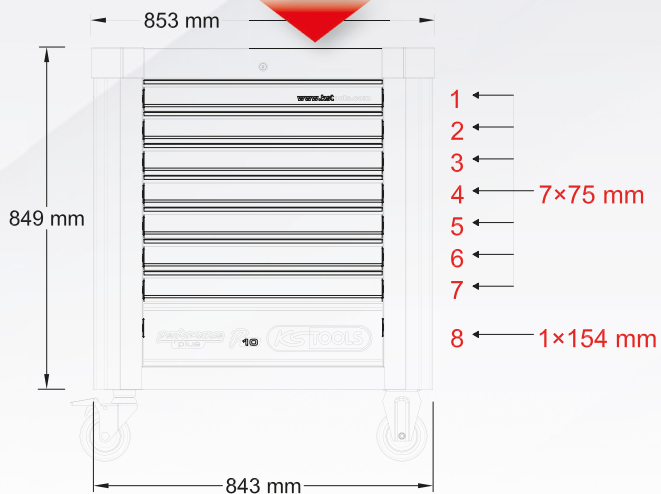

max.
50 kg

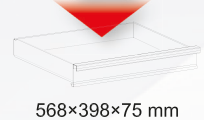

max.
50 kg



ODER WIE WÄR'S MIT DIESEM

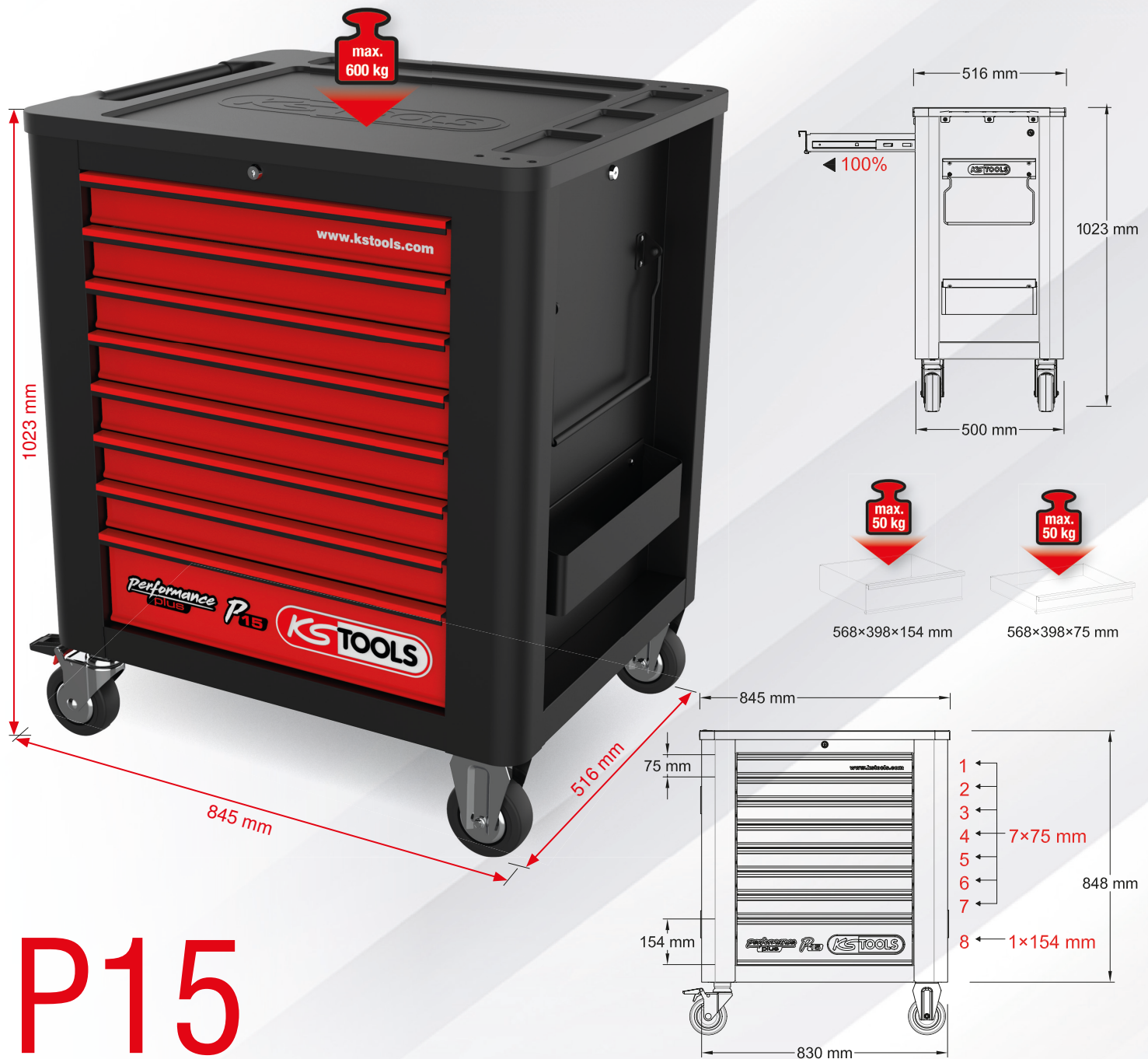

P15

PERFEKTE PERFORMANCE!

2.449,- €

815.7397

inklusive 397 Werkzeuge >>

PERFORMANCE PLUS

POWERPAKET?

performance
plus

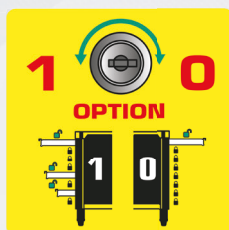

DUO Lock geniale
Verschluss-technik



8 Schubladen jeweils
bis zu 50 kg belastbar



Stabiles
Kugellager



Kunststoff-
oberfläche

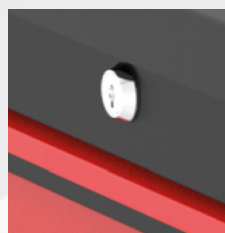

Schloss
abschließbar



Antistatische Rollen
mit Bremse



Integrierter
Kantenschutz



Inklusive
Papierrollenhalter



Inklusive
Dosenhalter

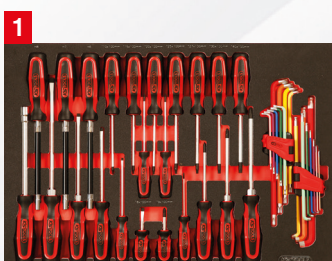

SCS ERGOTORQUEPLUS
SCHRAUBENDREHER-SATZ,
41-TLG

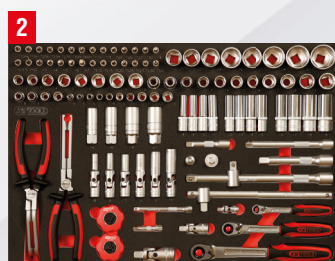

SCS 1/4\"/>

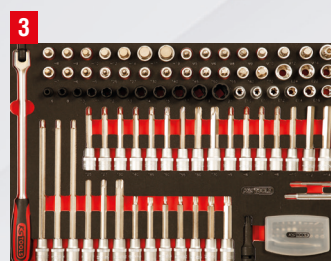

SCS 1/2\"/>

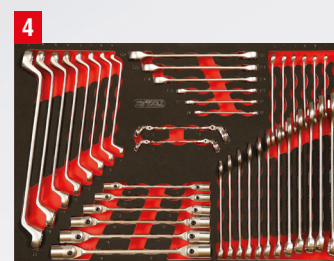

SCS
SCHLÜSSEL-SATZ,
41-TLG

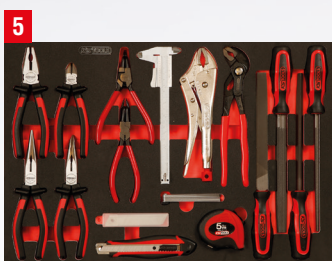

SCS ZANGEN-SATZ,
23-TLG



SCS REIFENDIENST-WERK-
ZEUG-SATZ, 43-TLG



SCS MEISSEL- UND
HAMMER-SATZ, 22-TLG



QR Code scannen für
detaillierte Sortimentsliste

P25

DER BREITE MIT DEM GROSSEN INHALT



3.099,- € ^{825.8564}

inklusive 564 Werkzeuge >>

PERFORMANCE PLUS



QR Code
scannen für
detaillierte
Sortimentsliste

performance
plus

3



SCS 1/2" STECKSCHLÜSSEL-SATZ, 86-TLG



4

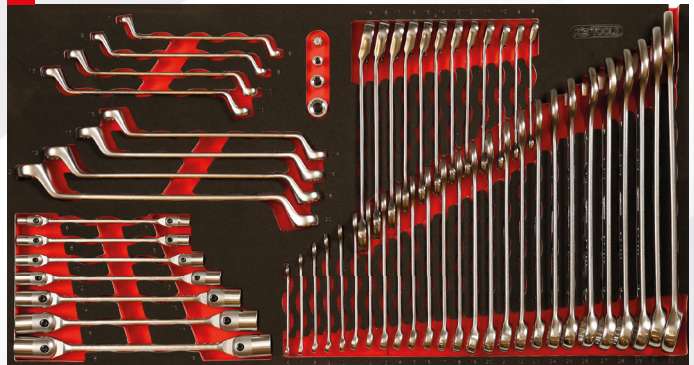

SCS SCHLÜSSEL-SATZ, 57-TLG



6-32 mm

7



SCS ZANGEN- UND MESSWERKZEUG-SATZ, 39-TLG



8



SCS 1/2" KRAFT-STECKSCHLÜSSEL- UND HAMMER-SATZ, 40-TLG



ACHT ERFOLGREICH

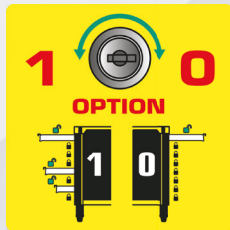

DUO Lock geniale Verschluss-technik



8 Schubladen jeweils bis zu 50 kg belastbar



Stabiles **Kugellager**



Edelstahloberfläche

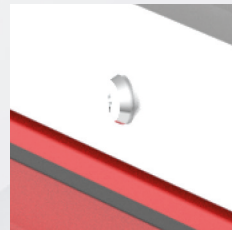

Schloss abschließbar

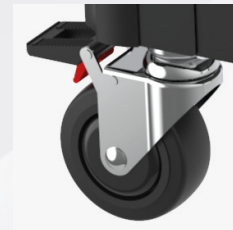

Antistatische Rollen mit Bremse



Integrierter **Kantenschutz**



Inklusive **Papierrollenhalter**



Inklusive **Dosenhalter**

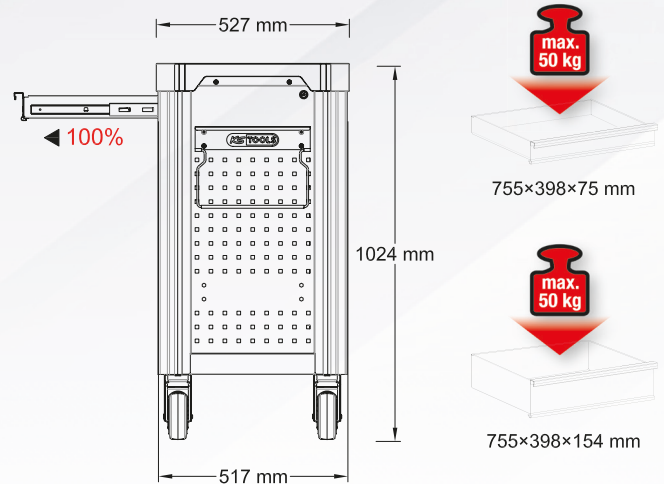
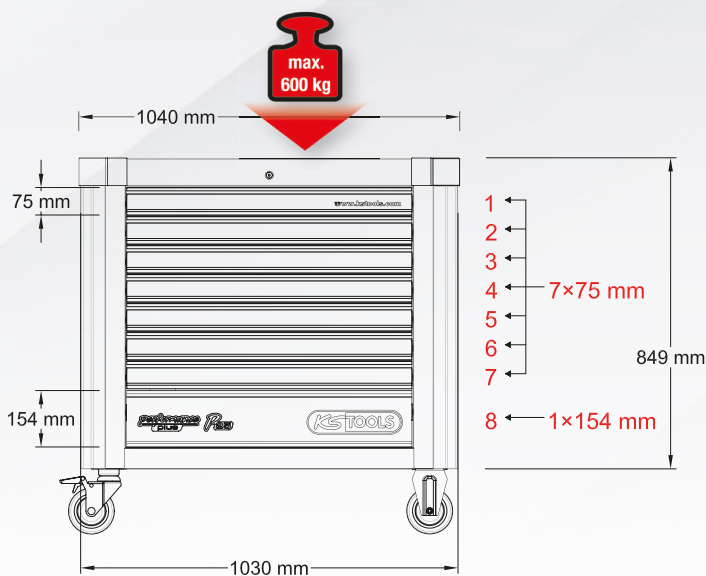

FÜR DIE BESTEN NUR DAS BESTE

20.000 Werkstattwagen bestätigen uns Jahr für Jahr: Nur wer beste Materialien verarbeitet, wird langfristigen Erfolg haben. Aber auch die hochwertigsten Werkzeugwagen sind nur so gut wie ihre inneren Werte. Deshalb bestücken wir jeden Performance Plus mit den besten Werkzeugen: unseren eigenen - aus dem KS TOOLS Premium-Sortiment, das mehr als 45.000 Artikel umfasst.

GARANTIERTE WERKZEUG-QUALITÄT

MADE BY KS TOOLS

Aus Erfahrung erstklassig

FÜR JEDEN DIE

PASSENDEN AUSWAHL

Alle Werkzeuge von Werkstattklassikern bis zu Spezialwerkzeugen



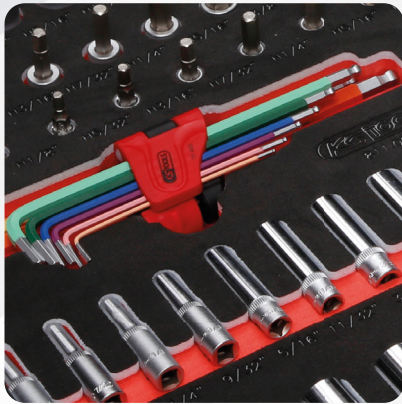
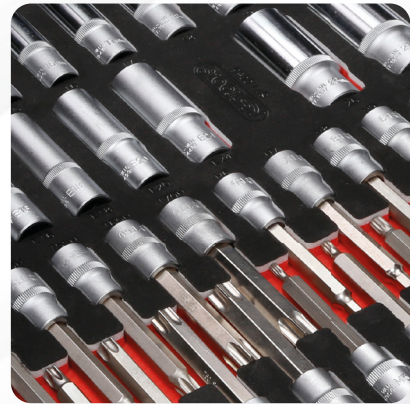
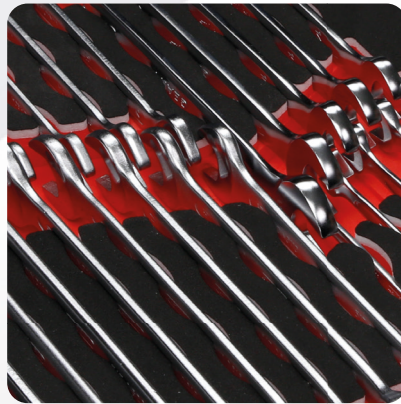

**Die Besten
aus 45.000
Premium-
Werkzeugen**

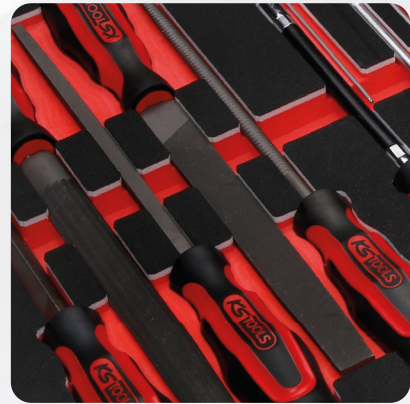

POWER UND PERFORMANCE AUF ÜBER 160 SEITEN!



www.myperformanceplus.de



Alle Werkstattwagen, alle Einlagen und alle Werkzeuge erleben Sie in unserem über 160-seitigen Katalog.



Ihr Partner:



KS Tools Werkzeuge - Maschinen GmbH
 Seligenstädter Grund 10-12
 63150 Heusenstamm
 Deutschland
 Tel.: +49 (0)6104 4974-0
 Fax: +49 (0)6104 4974-11
 E-Mail: info@kstools.de
www.myperformanceplus.de



LL20-43D_EUR

Alle Preise zzgl. der gesetzlichen Mehrwertsteuer. Mit Erscheinen dieses Prospektes verlieren alle vorangegangenen Preise hiermit ihre Gültigkeit. Verkauf nur an den Fachhandel. Druckfehler, Irrtümer und technische Änderungen vorbehalten. Preise gültig bis zum 31.03.2022