

performance
plus

PERFORMANCE IS MY PLUS



www.myperformanceplus.de

CATALOG
2021

Performance wants to know.

**PERFORMANCE GETS YOU IN
THE MOOD MORE THAN USUAL.**

**Performance is about to be
victorious.**

**PERFORMANCE IS PROOF
THAT IT IS POSSIBLE.**

**Performance enables human and
tool to become one.**

PERFORMANCE IS SEXY.

**Performance is when work makes
you proud like never before.**

WELCOME TO PERFORMANCE PLUS:



**The new premium class for
workshop trolleys.**

WE WANT TO REDEFINE THE WORKSHOP TROLLEY CLASS

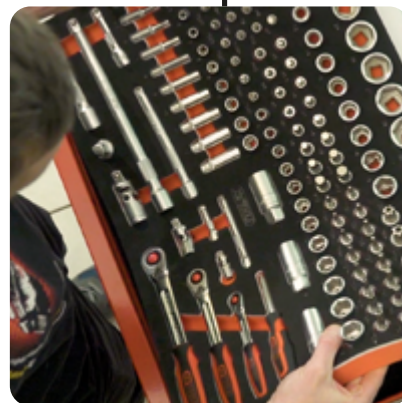
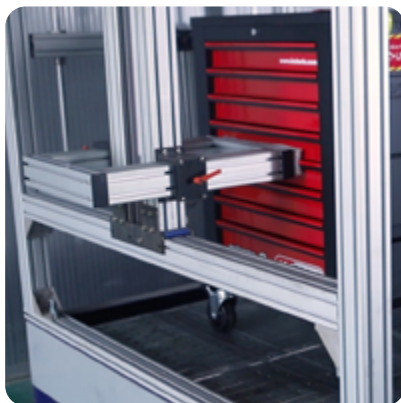

Performance
in moving images

Our mission: The best workshop trolley for industrial, car and commercial vehicle mechanics and for individuals with the most exacting demands.

We deliver more than we promise:

**CONSTRUCTED TO
MAXIMUM PERFECTION.**

Manufactured to the highest quality.

**GREATEST CONSISTENCY
IN PRICING.**

Non-compromising controls.

**THREE YEARS
INTENSIVE DEVELOPMENT.**

A yellow sports car is elevated on a dark grey hydraulic lift in a garage. The car is positioned on the right side of the frame. To the right of the car, there is a red rolling tool chest with multiple drawers. The chest has the 'K&S TOOLS' logo and 'Performance Plus' branding. The background shows a brick wall and large windows. A large red banner with white text is overlaid on the lower half of the image.

CONSTRUCTED BY DIE-HARD PERFECTIONISTS

Open drawer. Close drawer. Press the Duo Lock switch. Two drawers open simultaneously. Smooth as butter. No sticking, no creaking.

The Duo Lock, which all Performance Plus are equipped with, is a good example of our construction principles. It starts with an idea which makes the world of the workshop that little bit better. Then we work on the technical

implementation of this idea until we really have achieved perfection.

Only then can the Performance Plus rating plate be added to the trolley.

performance
plus



www.kstools.com

DUO-LOCK

performance plus P30

KS TOOLS

AN IDEA THAT MAKES THE WORLD THAT LITTLE BIT BETTER: DUO LOCK

**Sometimes the performance lies in the detail:
This smart innovation is the result of many years
of manufacturing expertise and intensive
development and is the key to greater efficiency
in daily work.**



UNIQUE ON THE MARKET



**THE SMART IDEA FOR GREATER
FLEXIBILITY IN EVERYDAY LIFE**

2 in 1 DUO-LOCK

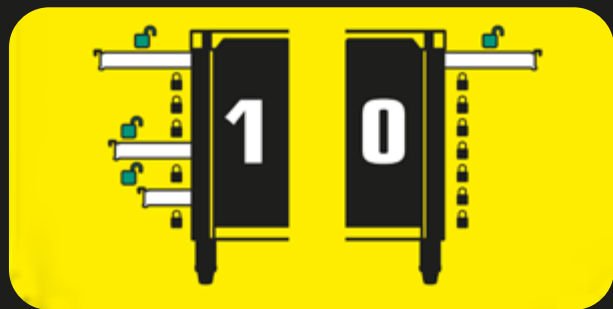

**MINIMAL RISK
OF TILTING**



MAXIMUM ACCESS



**MANUFACTURED
BY RADICAL
QUALITY FETISHISTS**



Open drawer. Close drawer. Open drawer... didn't we just see this text a moment ago? Not quite. Because "open and close" should actually appear 30,000 times. Carried out during the endurance test on one of our test benches.

Components that break during the test never make it into serial production. And, whatever does make it into serial production must demonstrate a consistently high level of quality at regular

intervals during random testing. At the end of the day, this is the difference between irritation and enthusiasm, between a service life of a few years or more than 20.

If you opt for high-quality products, you expect the same level of quality from the service. After all, Performance Plus is just as unique as you and your work.

**ALWAYS
THERE FOR YOU: YOUR
PERFORMANCE ASSISTANT**



Your personal contact kitted out the workshop trolley of your dreams in line with your requirements and checked it over before delivery. Of course, your contact is available to you at any time to answer any questions relating to Performance Plus.

CERTIFIED AND CHECKED

ALL PARTS AND TOOLS

Your guarantee for perfection

A CONTACT

FOR ALL CONCERNS

Round-the-clock availability

KNOWS THE INS AND OUTS OF

YOUR WORKSHOP TROLLEY

CALCULATED BY TOUGH COOKIES



Our experience speaks for itself: Those very customers who invest in a quality-conscious way are the ones who also pay close attention to the price. This is where our cost accountants and purchasers come into play. Because they make every Performance Plus cost-efficient.

They calculate, negotiate and optimise. Over and over again. The deciding factor: Out staff never – and when we say never, we mean never – accept compromises in quality and ultimately in the value that you receive as a customer. Instead, it is calculated, negotiated, and optimized again.

performance
plus



It's sometimes tough and always uncomfortable. But if it makes your decision for Performance Plus easier, then it has been more than worth it.

**IT IS BETTER TO BE SAFE
THAN SORRY.
OUR CHECKS ARE FIRST-
RATE.**



Timeless design, excellent quality, perfect processing. These are our ingredients for workshop trolleys that last for generations. From the initial idea to the final check, we do everything we can to achieve the best possible performance.

LONG-TERM TESTS

FOR ALL CASTORS

Drawers tested 30,000 times at maximum load capacity

48 HOURS OF LONG-TERM LOAD

TESTS FOR ALL COMPONENTS

100% of items checked individually

DELIVERED

FULLY ASSEMBLED AND

EQUIPPED WITH TOOLS

A red classic car, possibly a Ferrari, is shown from a front-three-quarter view with its hood open. The engine is visible, featuring various components like the carburetor, distributor, and belts. The car is parked in a brick building with large windows in the background. A red banner with white text is overlaid on the lower left portion of the image.

**CHECKED
BY NOTORIOUS
CONTROL FREAKS**



performance
plus



Your Performance Plus is just as unique as you and your work. Let's assume that the Performance Plus you configured includes 555 tools. So, how many do you receive? No, not 555.

But rather 556. Very deliberately. And this is also the only deviation that you can expect. Because the extra item included is a test certificate. It certifies that every single one of the 555 tools selected by you has been positioned in its place correctly. The certificate might be made of paper, but it is our rock-solid proclamation of tested quality. It bears the name, signature and mobile phone

number of a member of our test team, who is personally responsible for your Performance Plus.

This 556th part is therefore your direct line to advice, action and commitment – and might just be the most valuable and powerful tool we supply you with.



“When I joined the Performance Plus construction team, I heard someone say: A job is not well done when it is finished, it is finished when it is well done. That really hits the nail on the head. And the great thing is: Everyone in the team thinks this way. Sometimes you don’t even need to say the words. What people are thinking is in the air: Hey, we can go even further! Then we draw up the plans again and end up with something much better.”

Thomas Tenga,
die-hard perfectionist at KS Tools



“Dubious manufacturing tolerances are often referred to using euphemisms like “manufacture.” That’s not my thing. At KS Tools, we work with state-of-the-art machines and my ambition is to extract as much precision as possible. And then to make even more improvements. And then to improve on that again. So that we can create a premium product like Performance Plus.”

Orhan Altin,
radical quality fetishist at KS Tools



“

“Tough – this is a label I can live with. Because tough is not the same as unfair. I demand a lot from our suppliers, but I never make an enemy of them. For me, Performance Plus is a product created in partnership. KS Tools, our suppliers and our customers all have one thing in com-mon: We all want to create excellence – that will stand the test of time.”

Christian Niebeling,
tough cookie at KS Tools



“

“I am the last in a long line of colleagues who work on a Performance Plus. Everyone before me made such a huge effort to create a great product, which is why I give my all during assembly before the shipping box is closed. So that you can unbox the Performance Plus and get started straight away.”

Thomas Kochhafen,
notorious control freak at KS Tools

FIRST-CLASS FROM EXPERIENCE

20,000 workshop trolleys are proof of this year for year: Longterm success only comes to those who use the best materials. We have taken this principle to the extreme with Performance Plus. The best materials and high-quality equipment ensure that you will still be enjoying your workshop trolley in many years to come.



THE BEST IS GOOD

ENOUGH FOR US

Four steerable castors with brakes

**BALL BEARINGS ONLY FROM
RENOWNED MANUFACTURERS**

Five years' warranty on all parts



ONLY THE BEST FOR THE BEST

Even the highest quality workshop trolleys are only as good as their inner values. That's why we equip every Performance Plus with the best tools from the KS TOOLS Premium range, which offers more than 45,000 items.

**GUARANTEED QUALITY
MADE BY KS TOOLS**

Thoughtful compilation

**THE RIGHT CHOICE
FOR EVERYONE**

Everything from workshop classics to special tools

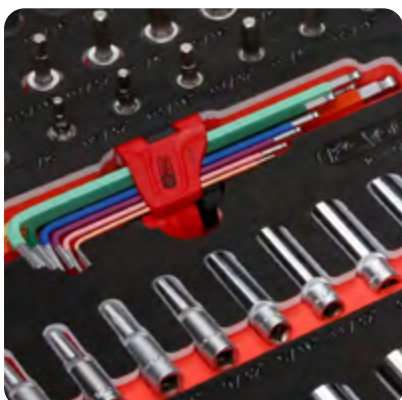
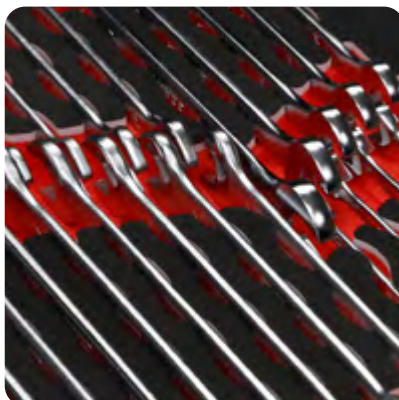

**The best from
45,000 premium
tools**

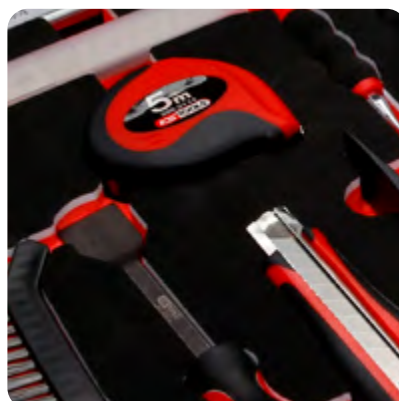
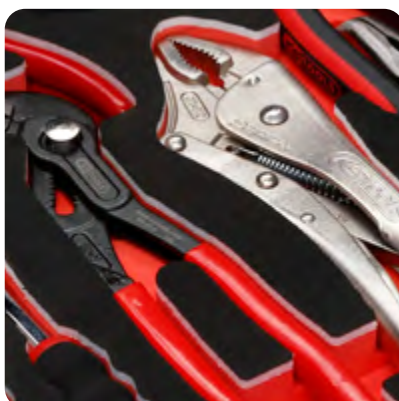
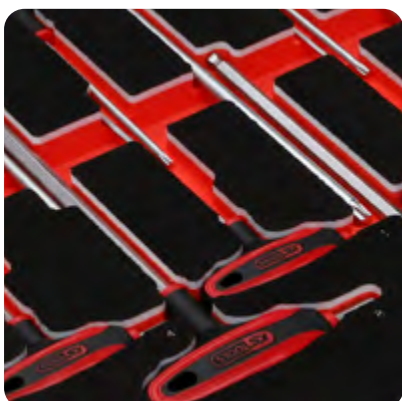
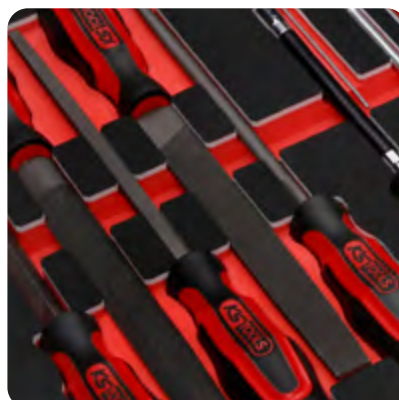

For the Performance Plus workshop trolleys to work, hundreds of individual parts need to work together in perfect harmony.

In order to ensure that your workshop trolley is just as reliable in many years as it is on the day you got it, we guarantee you that every component is interchangeable.

MORE THAN THE SUM OF ITS PARTS

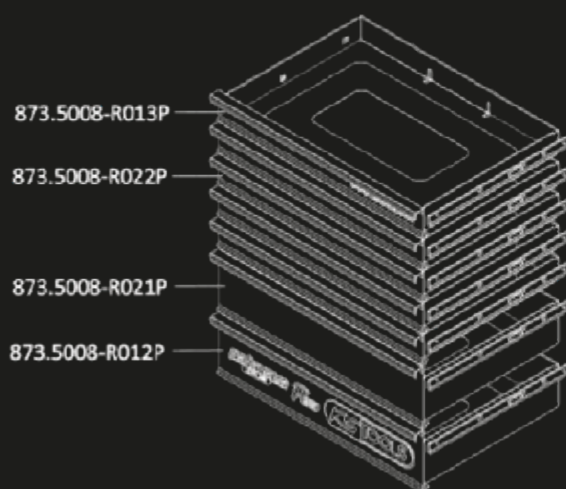

AFTERSALES WARRANTY

ON ALL PARTS

Easy exchange

QUICK AVAILABILITY FOR

CONTINUOUS PERFORMANCE

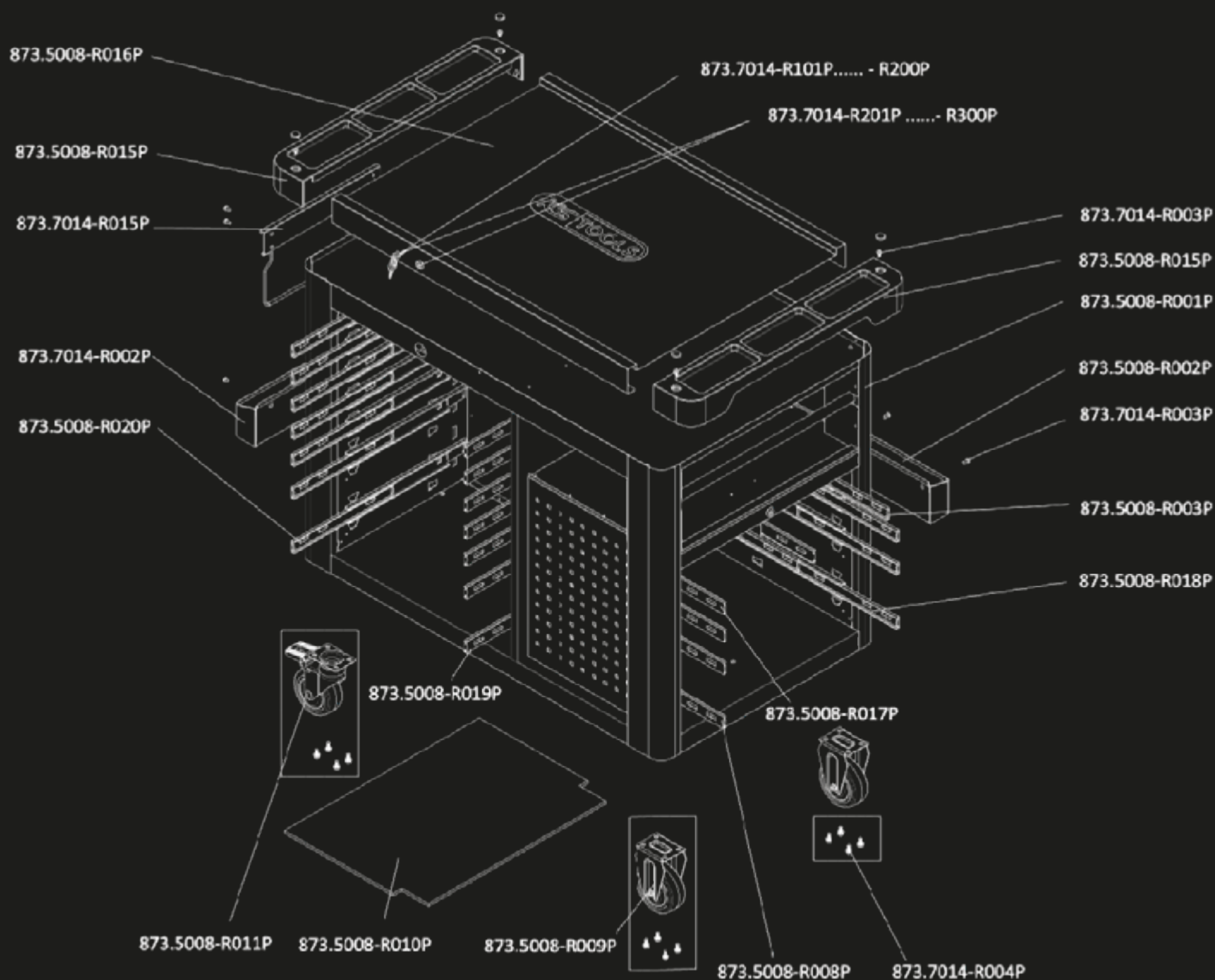

We have designed the drawers of our Performance Plus workshop trolleys in four sizes to cater to individual design options.

The tool inserts are tailored to the drawer sizes based on our experience from decades of tool production.

SUCCESSFULLY THINKING INSIDE THE BOX

**S, M, L, XL: FOUR SIZES FOR
A BETTER OVERVIEW**

**OVER 100 PREASSEMBLED
TOOL INSERTS**

**The combination possibilities are
practically endless**

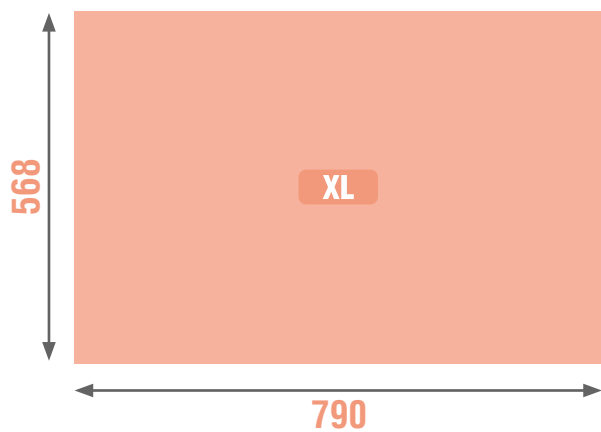
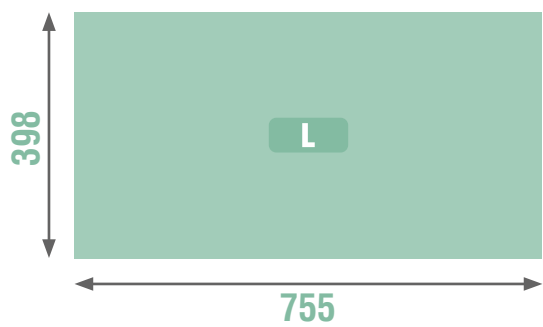
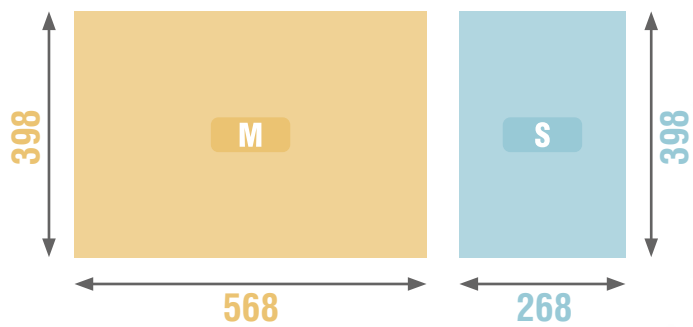

READY FOR USE STRAIGHT AWAY FOR BETTER PERFORMANCE IN SERVICE

**Performance from the first moment:
Every trolley is delivered not only fully
assembled with castors attached,
but also fully equipped with the insert
packages you selected.**

**WELL-THOUGHT-OUT INSERT
PACKAGES FOR ALL APPLICATIONS**

**ALREADY INSERTED
IN YOUR TROLLEY**

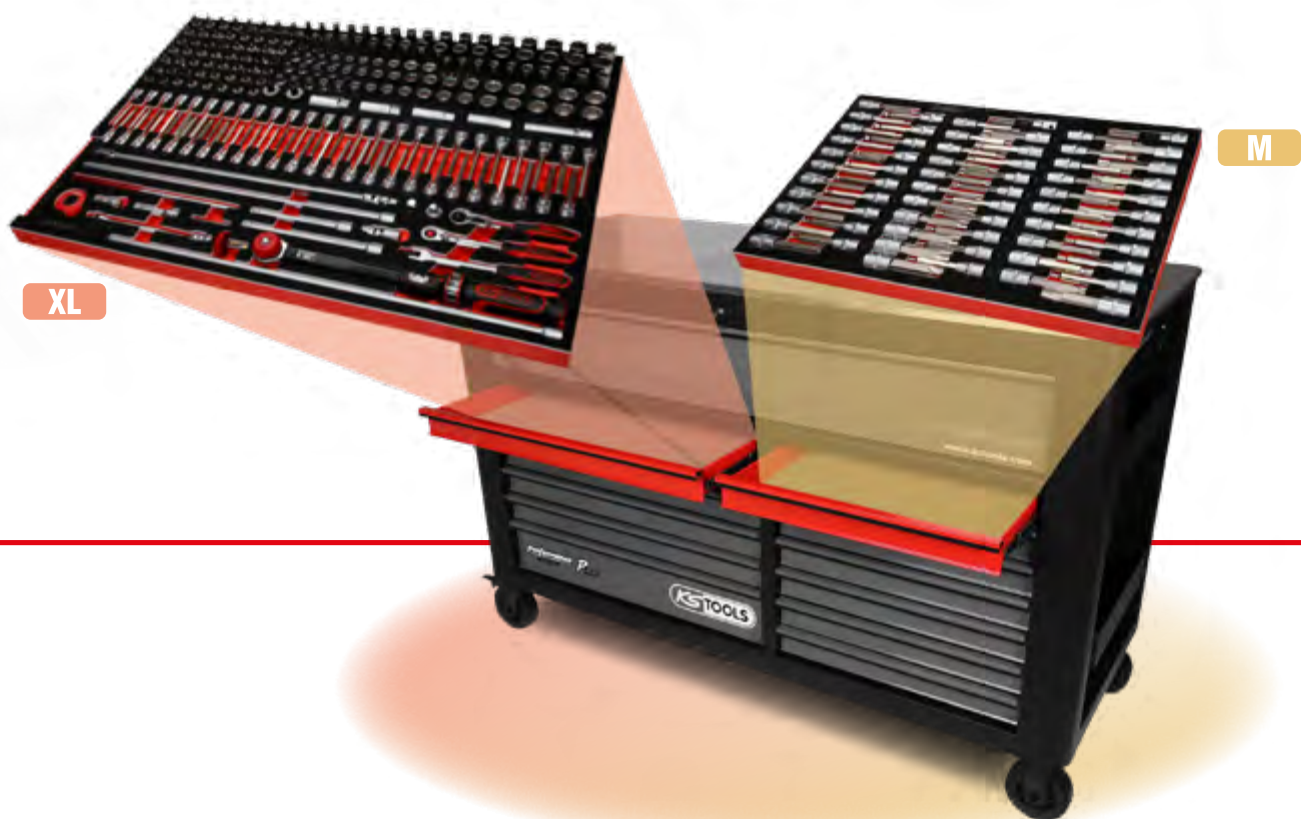

WHICH WORKSHOP TROLLEY IS RIGHT FOR YOU?

How big does it need to be? How many drawers should it have and which drawer size would be ideal? We have developed nine workshop trolleys for you. The most important features are displayed in the matrix below.

ALL GUARANTEED TO INCLUDE EX WORKS:
HIGH QUALITY THAT YOU WILL CONTINUE TO
ENJOY IN MANY YEARS TO COME

	P10	P10TC	P15	P20	P25	P30	P35	P40	P45
Dimensions (W x H x D)	853 x 1024 x 527	853 x 454 x 527	845 x 1023 x 516	1067 x 1023 x 646	1040 x 1024 x 527	1075 x 1024 x 657	1232 x 1027 x 741	1701 x 1017 x 710	1701 x 1132 x 710
No. of drawers	8	4	8	8	8	8	8	4	15
Drawer formats	2	1	2	2	2	2	4	1	3
Drawer sizes	568 x 398 x 75 568 x 398 x 154	568 x 398 x 75	568 x 398 x 75 568 x 398 x 154	790 x 568 x 75 790 x 568 x 154	755 x 398 x 75 755 x 398 x 154	568 x 398 x 75 568 x 398 x 154	790 x 568 x 75 790 x 568 x 154	1429 x 568 x 197 1429 x 568 x 154	1429 x 568 x 197 568 x 568 x 75 790 x 568 x 75 790 x 568 x 154
Max. load capacity in kg	600 kg	400 kg	600 kg	600 kg	600 kg	600 kg	600 kg	1000 kg	1000 kg
Stainless steel worktop	•	•			•	•	•	•	•
DUO-Lock	•	•	•	•	•	•	•	•	•
Lockable	1x	1x	1x	1x	1x	1x	2x	1x	1x

CONTENT



page 34

P10

With tool inserts
from page 68



page 40

P15

With tool inserts
from page 88



page 44

P20

With tool inserts
from page 108



page 48

P25

With tool inserts
from page 110



page 52

P30

With tool inserts
from page 120



page 56

P35

With tool inserts
from page 122



page 60

P40



page 64

P45

With tool inserts
from page 126

from page 132

Individual inserts

from page 292

Individual parts

from page 314

Accessories

P 10

P 15

P 20

P 25

P 30

P 35

P 40

P 45

Single inserts

Individual parts

Accessories

Workshop trolley P10

with 8 compartments

873.0008

THE ENTRY MODEL TO SATISFY HIGH STANDARDS



► Performance in comfort:

Preassembled insert packages with the best tools for almost every application for the P10 can be found from page 68

P10

649,– ^{EUR}

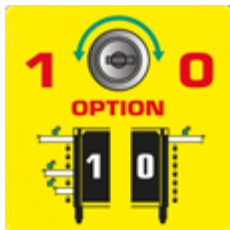

DUO Lock Brilliant locking system



Eight drawers each load capacity up to 50 kg



Stable **ball bearing**



Stainless steel surface

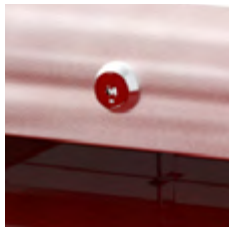

Lock lockable



Anti-static castors with brakes



Integrated **corner protection**



Paper roll holder included



Can holder included

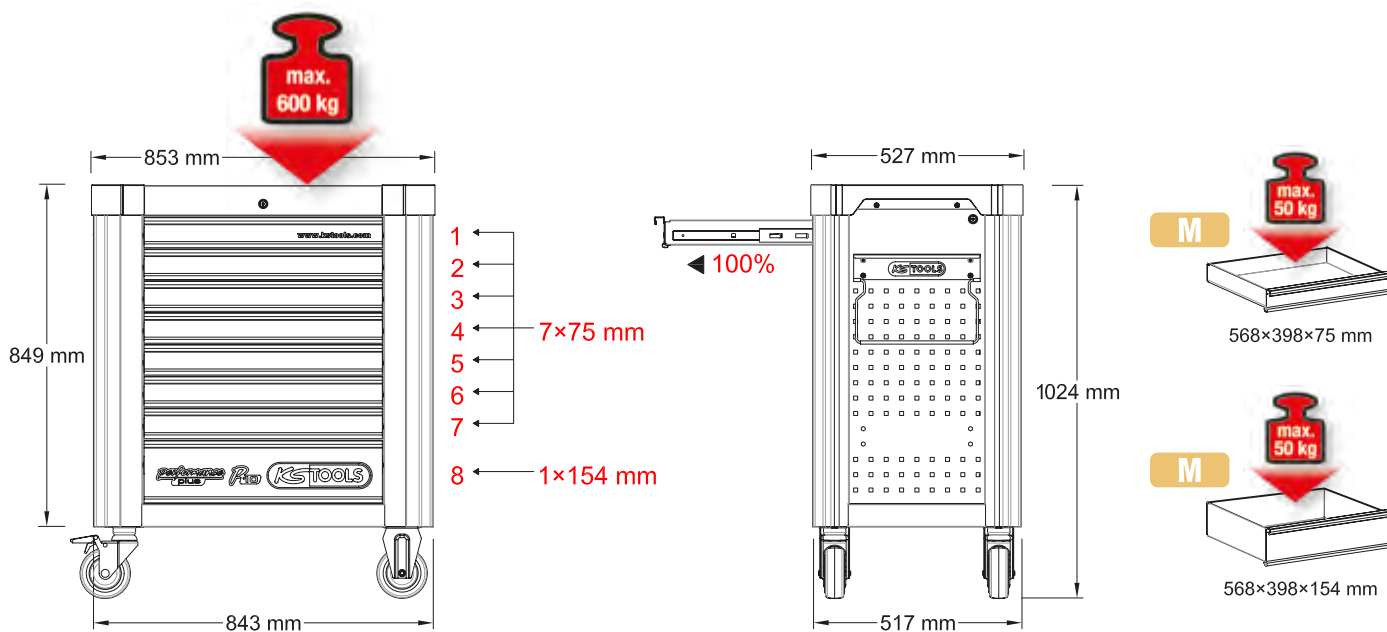

Workshop trolley attachment P10TC

with 4 compartments

873.0004

AND ON TOP OF THAT!



P10TC

429,-^{EUR}



DUO Lock Brilliant locking system



Four drawers each load capacity up to 50 kg



Stable **ball bearing**

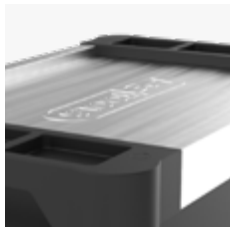

Stainless steel surface

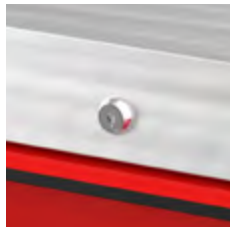

Lock lockable



Stable grip easy to transport

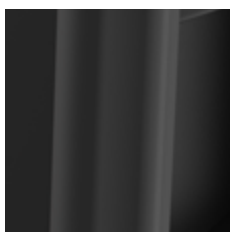

Integrated **corner protection**

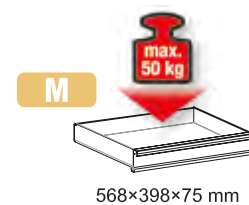
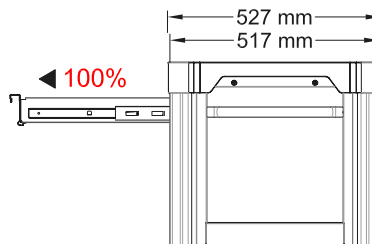
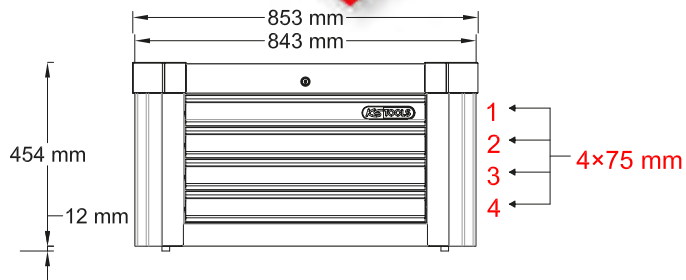



performance
plus



**PERFORMANCE IS
YOUR PLUS!**

THE COMPACT HEAVYWEIGHT

P15



► Quick & Easy

Want to get started right away? Then why not opt for our preassembled insert packages for almost any application, for the P15 from page 88

Workshop trolley P15
with 8 compartments
873.1008

799,-^{EUR}

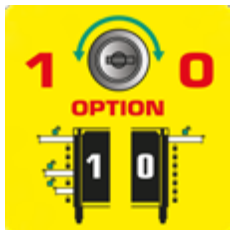

DUO Lock Brilliant locking system



Eight drawers each load capacity up to 50 kg



Stable **ball bearing**



Plastic Surface



Lock lockable



Anti-static castors with brakes



Integrated **corner protection**



Paper roll holder included



Can holder included

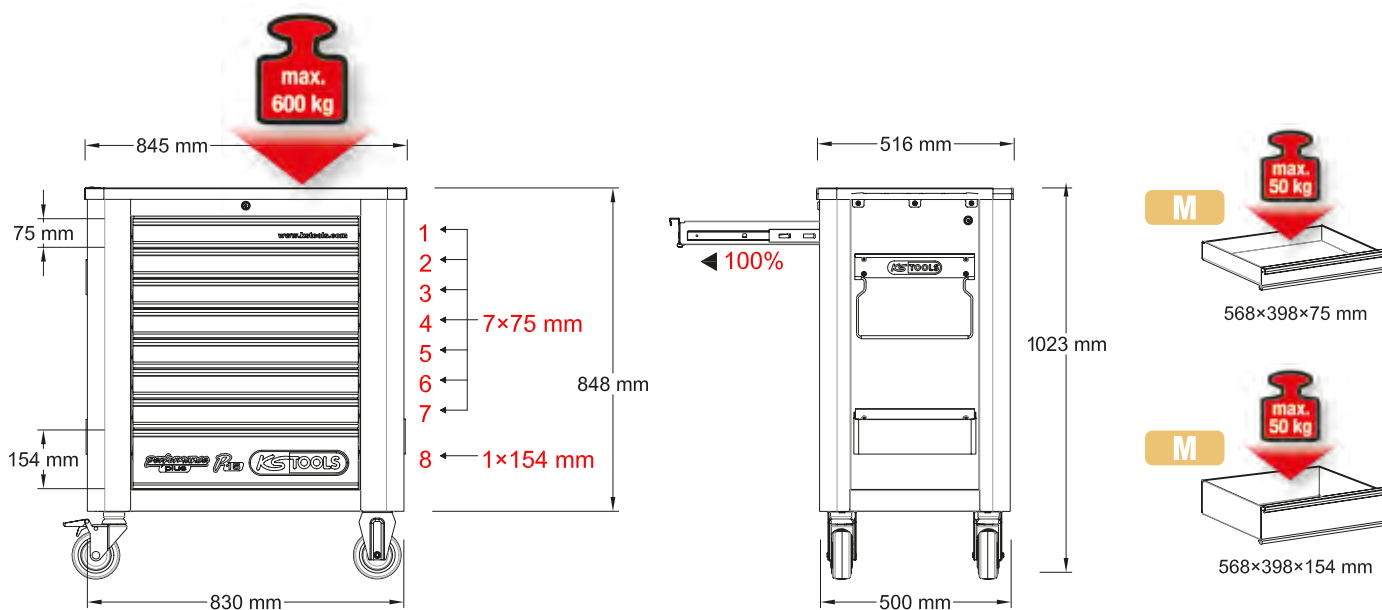

An aerial, high-angle view of a race track curving through a lush, green landscape. Two race cars, one red and one green, are visible on the track. The scene is bathed in warm, golden light, suggesting a sunrise or sunset. The track is bordered by a concrete wall and a grassy area with trees. The overall atmosphere is one of speed and precision.

JUST ONE LAST BEND AND OUR TEAM WILL SPRING INTO ACTION.

Even though we aren't in the driving seat of a race car and there is no team order or imminent wheel changes – we are still here with you.

Because we are there for our users. Here at KS Tools, we are a united team, with all our expertise, our passion and our responsibility for the moment when it really matters. Our mission: to provide first-class tools to front-line users. At the races on Sunday, at your company from Monday.

performance
plus



MORE WIDTH, MORE DEPTH, MORE TOOLS

P20



► **Performance in a package**

Our insert packages contain the perfect mix of tools. Especially for the P20 from page 108

Workshop trolley P20
with 8 compartments
873.2008

999, — ^{EUR}



DUO Lock Brilliant locking system



8 Drawers each load capacity up to 50 kg



Stable **ball bearing**



Plastic Surface

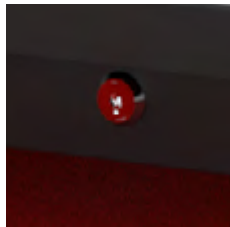

Lock lockable



Anti-static castors with brakes



Integrated **corner protection**



Paper roll holder included



Can holder included

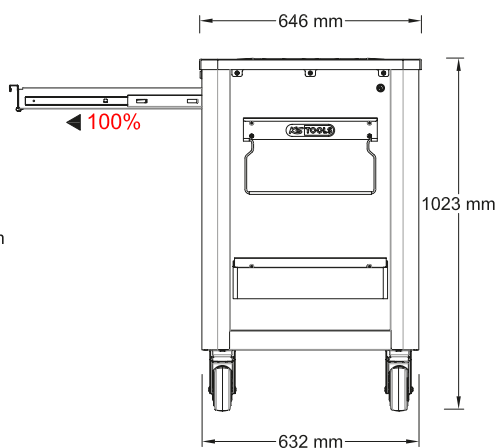
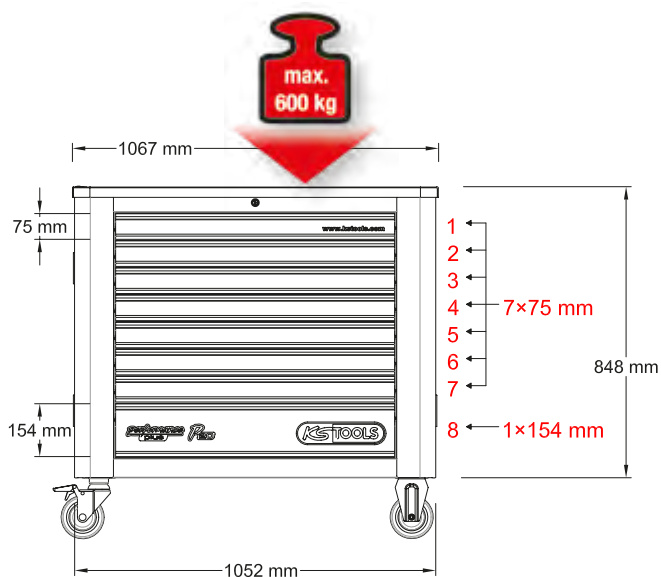



GREEN LEADS, RED WINS

It is well known that races are also won in the pits. Nerves of steel and equipment that can keep up are what matters.

But heroes' stories of maximum performance under high pressure are not just written at Monza and Le Mans.

You can be the protagonist too. With durable precision that can be recognised by the red Performance Plus trolley.

performance
plus



PRECIOUS WIDTH



► **Complete performance**

We have preassembled a series of insert packages for you drawing on our decades of experience. For the P25 from page 110

Workshop trolley P25
with 8 compartments
873.3008

749,-^{EUR}

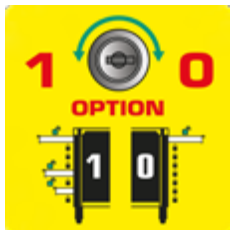

DUO Lock Brilliant locking system



8 Drawers each load capacity up to 50 kg



Stable **ball bearing**



Stainless steel surface



Lock lockable



Anti-static castors with brakes



Integrated **corner protection**



Paper roll holder included



Can holder included

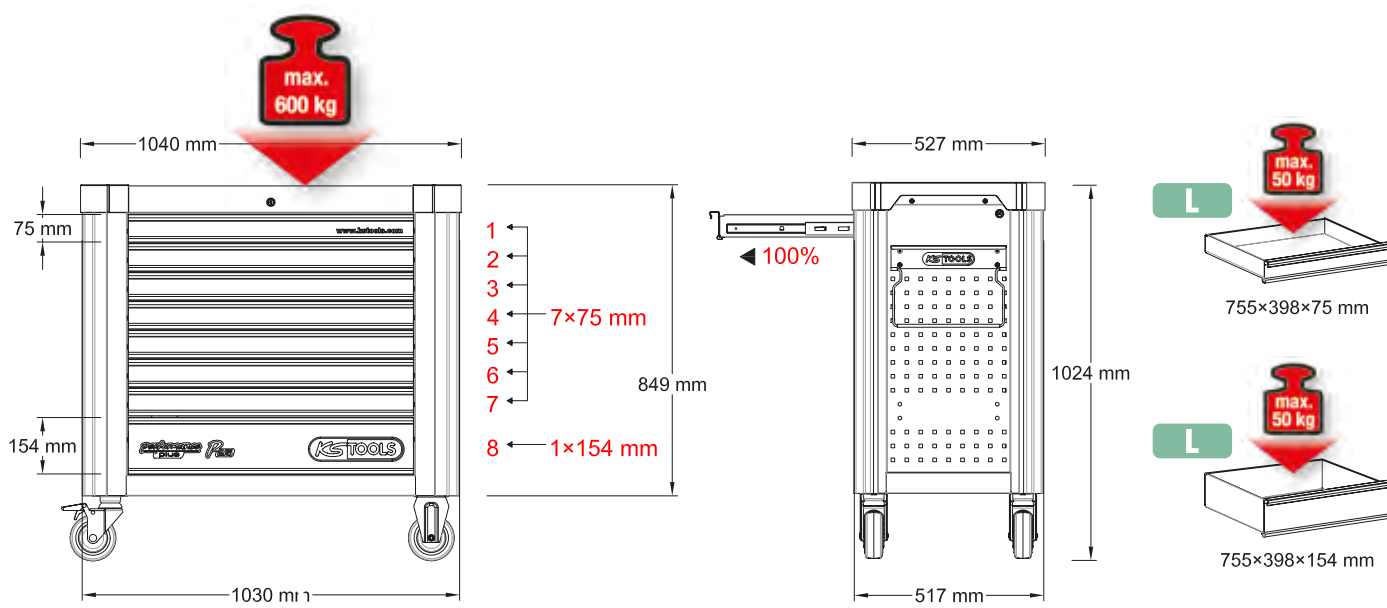

Verstärkte GT3-
Leidenschaftliche Freude,
präzise umgesetzt



**BORN A CLASSIC.
WITH THE FUTURE
IN ITS GENES.**



A Performance Plus is the workshop trolley that lasts for generations. When they retire, some champions will say goodbye to “their” Performance Plus which had been their faithful companion since their apprentice days.

This is exactly why each Performance Plus is given a fantastic timeless design and is exceptionally robust. And what if you lose something over the years?

You can purchase both the individual parts of the trolley and even the smallest tool without any problems at a later date. Performance Plus. A great future on small wheels.

WANT TO GO INTO MORE DETAIL?



► **Ready to go**

Do you want the necessary tools for your P30 to already be installed in your new workshop trolley? You can find the universal insert package on page 120

Workshop trolley P30
with 8 compartments
873.4008

1.049,-^{EUR}



DUO Lock Brilliant locking system



8 Drawers each load capacity up to 50 kg



Stable **ball bearing**



Stainless steel surface



Lock lockable



Anti-static castors with brakes

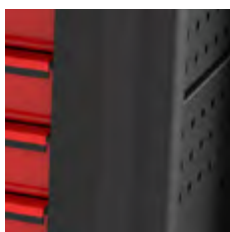

Integrated **corner protection**



Paper roll holder included



Can holder included

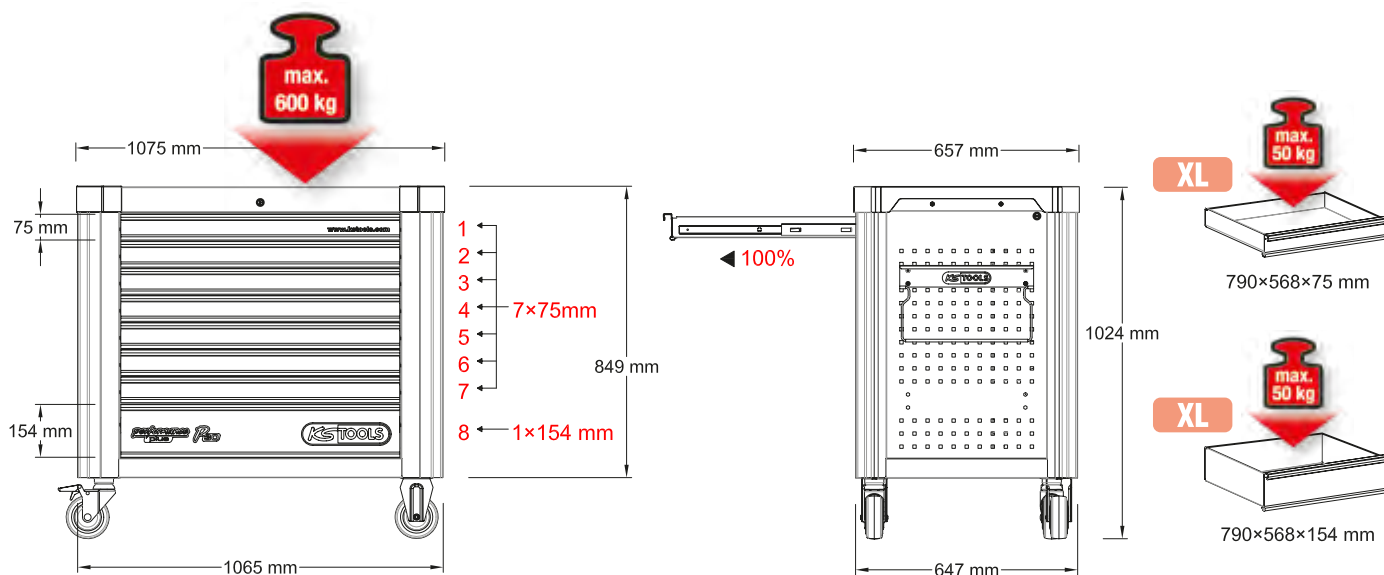



PERFORMANCE ON FOUR WHEELS IS NOT A QUESTION OF TYRE SIZE.

**We have packed a lot into the small, quick wheels of our workshop trolleys:
powerful tools, exemplary ergonomics, a well-engineered overall design and, above all, proven durability.**

For there is one thing we have learnt from motor sport: Success only comes to those who cross the finish line quickly and without any glitches. A future on small wheels.

performance
plus

PERFORMANCE



INNOVATIVE THINKING FOR GREATER EFFICIENCY!



► **Perfect performance**

Choose one of our special insert packages:
The best tools for the P35 from page 122

Workshop trolley P35
with 12 compartments
873.5008

1.499,-^{EUR}



DUO Lock Brilliant locking system



Twelve drawers each load capacity up to 50 kg



Stable **ball bearing**



Stainless steel surface



Two locks lockable



Anti-static castors with brakes

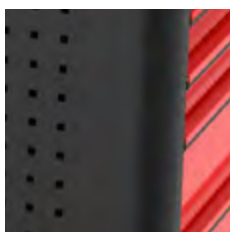

Integrated **corner protection**



Paper roll holder included



Can holder included

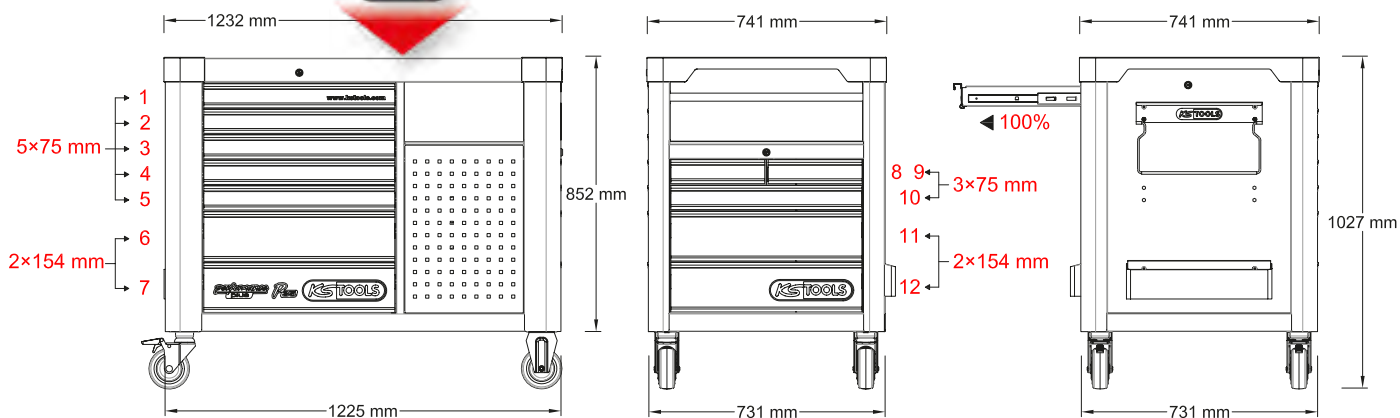
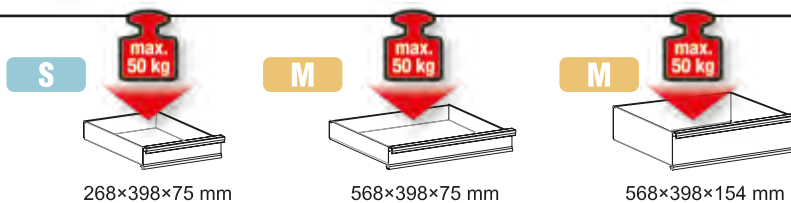



**PERFORMANCE
IS UNIQUE!**

performance
plus



www.kstools.com

KS TOOLS

P25

HIGH DRAWERS FOR THE HIGHEST DEMANDS

P40



Workshop trolley P40
with 4 compartments
873.6008

1.949,– ^{EUR}



DUO Lock Brilliant locking system



Four drawers each load capacity up to 65 kg



Stable **ball bearing**



Stainless steel surface

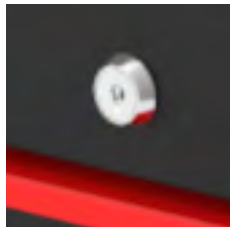

Lock lockable



Anti-static castors with brakes

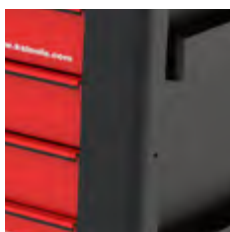

Integrated **corner protection**



Paper roll holder included



Can holder included

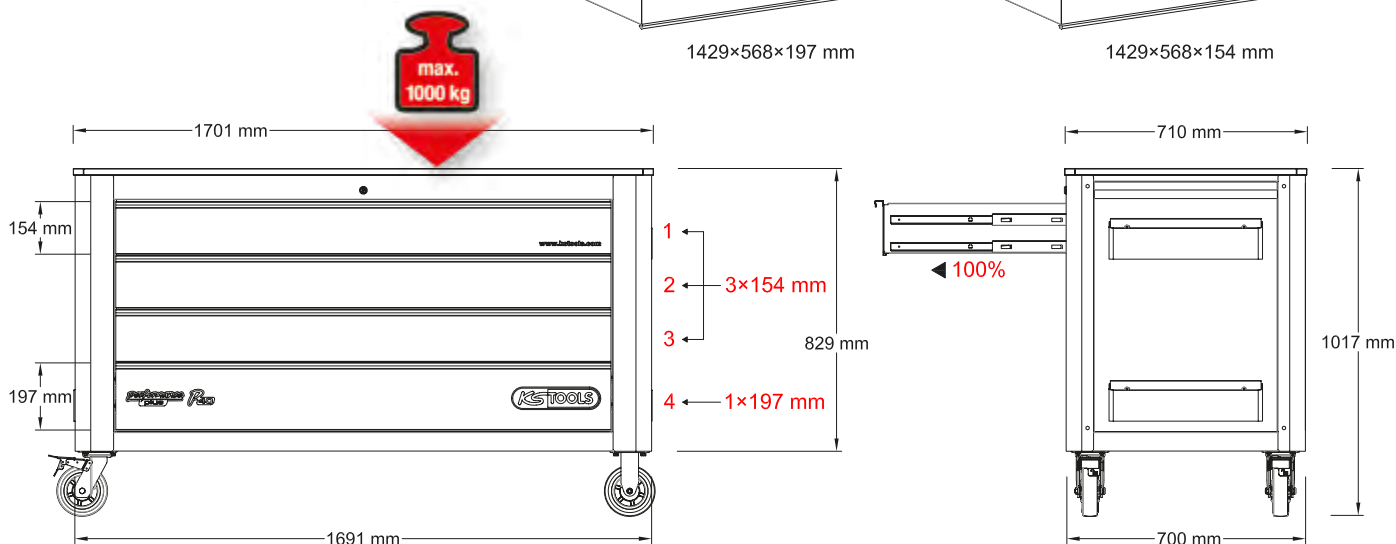
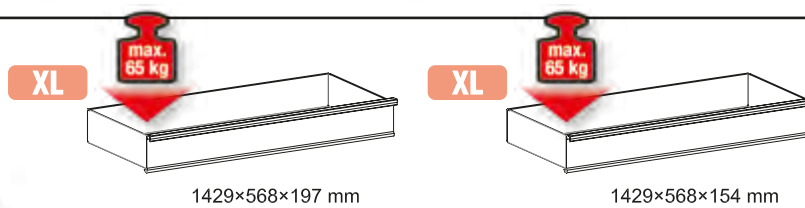



[www.ksto](http://www.ksto.com)

performance **P₁₀** **KS TOOLS**
plus

performance
plus

ols.com

OLS

**PERFORMANCE
BREEDS
SUCCESS!**

THE SPACESHIP OF YOUR DREAMS FOR THE WORKSHOP!



► **Fantastic performance**

Insert packages for the P45, put together by drawing on our dec-ades of experience, from page 126

Workshop trolley P45
with 14 compartments

873.7014

2.249,- ^{EUR}



DUO Lock Brilliant locking system



Fourteen drawers each load capacity up to 65 kg



Stable **ball bearing**

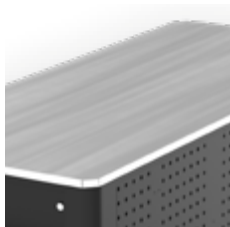

Stainless steel surface

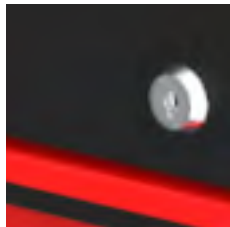

Lock lockable



Anti-static castors with brakes



Integrated **corner protection**



Paper roll holder included



Can holder included

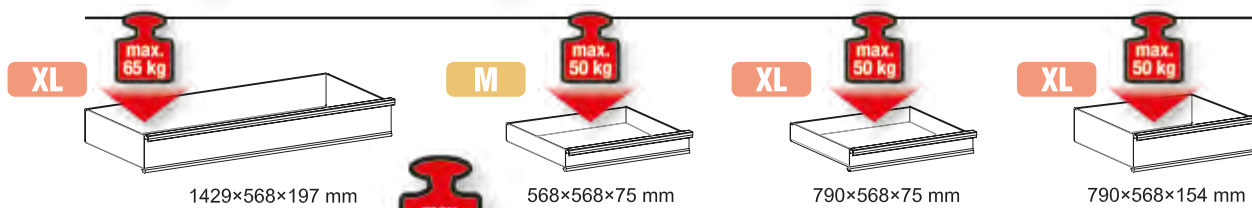

1429×568×197 mm

568×568×75 mm

790×568×75 mm

790×568×154 mm

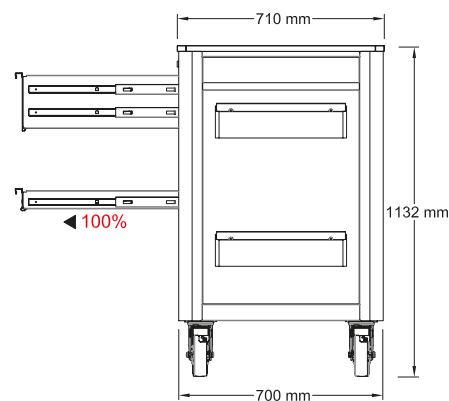
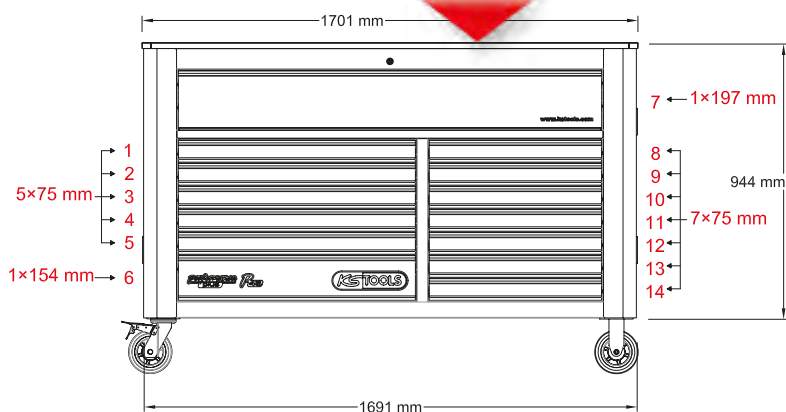

PERFORMANCE IN A PACKAGE

**Performance from the very first moment:
Every trolley is delivered not only fully
assembled with castors attached, but
also fully equipped with the insert
packages you selected.**

WELL-THOUGHT-OUT INSERT

PACKAGES FOR ALL APPLICATIONS

ALREADY INSERTED

IN YOUR TROLLEY



45 DIFFERENT INSERT PACKAGES

CONTENT



P10

P10 Workshop trolley pages
for 4 drawers 68 - 69
for 5 drawers 70 - 72
for 6 drawers 73 - 79
for 7 drawers 80 - 85
for 8 drawers 86 - 87



P15

P15 Workshop trolley pages
for 4 drawers 88 - 89
for 5 drawers 90 - 92
for 6 drawers 93 - 99
for 7 drawers 100 - 105
for 8 drawers 106 - 107



P20

P20 Workshop trolley pages
for 9 drawers 108 - 109



P25

P25 Workshop trolley pages
for 4 drawers 110
for 6 drawers 111 - 112
for 7 drawers 114 - 115
for 8 drawers 116 - 119



P30

P30 Workshop trolley pages
for 7 drawers 120 - 121



P35

P35 Workshop trolley pages
for 5 drawers 122
for 12 drawers 124 - 125



P45

P45 Workshop trolley pages
for 7 drawers 126 - 127
for 13 drawers 128 - 131

P10 workshop tool trolley set with 241 tools for 4 drawers

810.4241



241





BUNDLE PRICE!

4 x M
241 pcs

1.299,--^{EUR}
810.4241

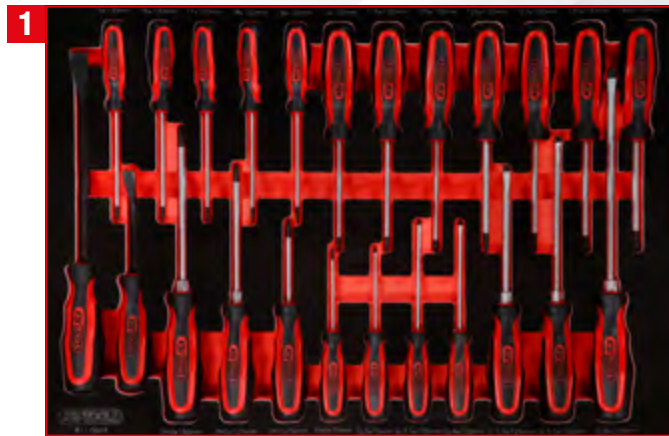

Screwdriver set in foam insert

811.0024

For a detailed list of tools, see page 186



24



1/4" + 3/8" + 1/2" socket spanner set in foam insert

811.0159

For a detailed list of tools, see page 172



159

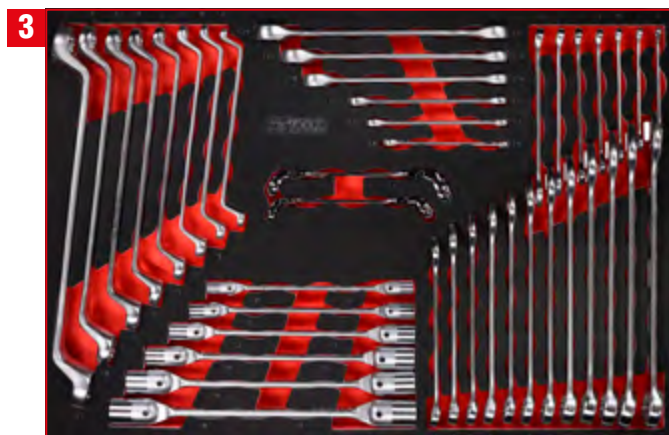

Screw spanner set in foam insert

811.1041

For a detailed list of tools, see page 204



41



Pliers, hammer and chisel set in foam insert

811.0017

For a detailed list of tools, see page 220



17

P10 workshop tool trolley set with 180 tools for 4 drawers

810.4180

180 PCS
180

M



BUNDLE PRICE!

**4 x M
180 pcs**

1.399,--^{EUR}
810.4180

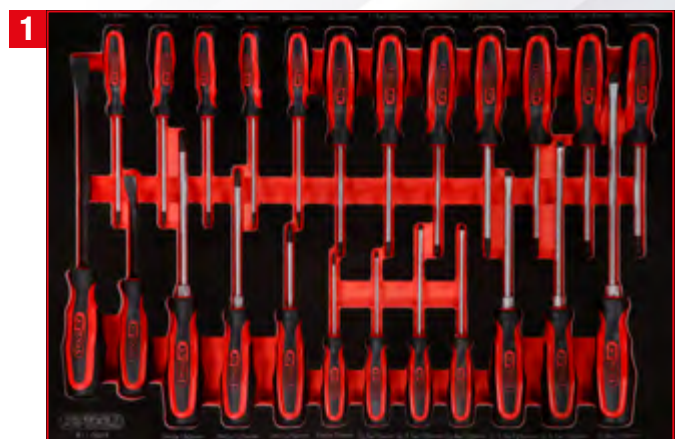

Screwdriver set in foam insert

811.0024

For a detailed list of tools, see page 186

24 PCS



1/4" + 3/8" + 1/2" socket spanner set in foam insert

811.0092

For a detailed list of tools, see page 174

92 PCS



Screw spanner set in foam insert

811.0031

For a detailed list of tools, see page 218

31 PCS



Pliers, hammer and chisel set in foam insert

811.0033

For a detailed list of tools, see page 228

33 PCS

P 10

P 15

P 20

P 25

P 30

P 35

P 40

P 45

Single inserts

Individual parts

Accessories

P10 workshop tool trolley set with 262 tools for 5 drawers

810.5262



M

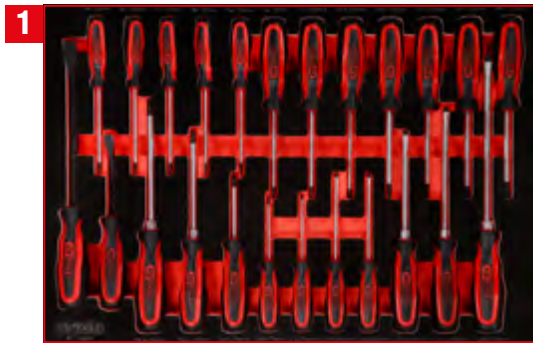

Screwdriver set in foam insert

811.0024

For a detailed list of tools, see page 186



1/4" + 3/8" + 1/2" socket spanner set
in foam insert

811.0159

For a detailed list of tools, see page 172



Screw spanner set in foam insert

811.1040

For a detailed list of tools, see page 203



T-handle and screwdriver set in foam
insert

811.1022

For a detailed list of tools, see page 194

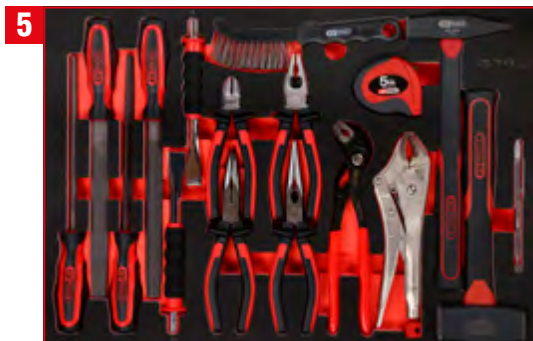

Pliers, hammer and chisel set in foam
insert

811.0017

For a detailed list of tools, see page 220

BUNDLE PRICE!

**5 x M
262 pcs**

1.599,-^{EUR}
810.5262

P10 workshop tool trolley set with 279 tools for 5 drawers

810.5279



M

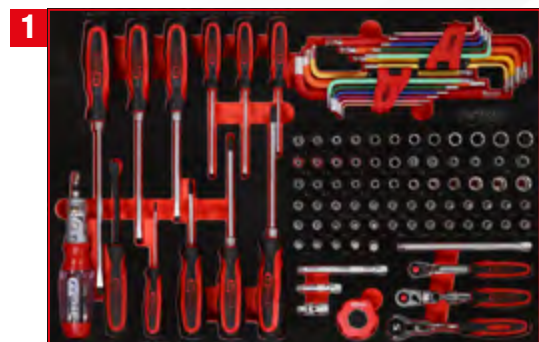

1/4" socket spanner and screwdriver set in foam insert

811.0105

For a detailed list of tools, see page 198



3/8" + 1/2" socket spanner set in foam insert

811.0101

For a detailed list of tools, see page 152



Screw spanner set in foam insert

811.1040

For a detailed list of tools, see page 203

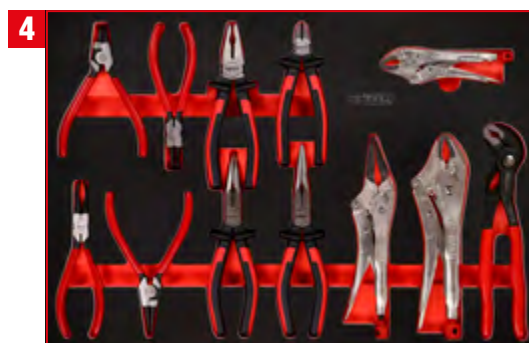

Spanner set in foam insert

811.0012

For a detailed list of tools, see page 219



Hammer, chisel and file set in foam insert

811.0021

For a detailed list of tools, see page 222

BUNDLE PRICE!

**5 x M
279 pcs**

**1.649,--
810.5279**

P 10

P 15

P 20

P 25

P 30

P 35

P 40

P 45

Single inserts

Individual parts

Accessories

P10 workshop tool trolley set with 299 tools for 5 drawers

810.5299



M

BUNDLE PRICE!

5 x M / 299 pcs

1.749,-^{EUR}

810.5299



1



Screwdriver set in foam insert

811.0034

For a detailed list of tools, see page 189

2

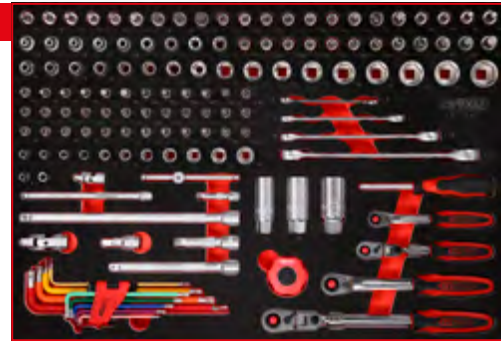

1/4" + 3/8" socket spanner set in foam insert

811.0140

For a detailed list of tools, see page 138

3



1/2" screwdriver bit set in foam insert

811.0064

For a detailed list of tools, see page 162

4



Screw spanner set in foam insert

811.0038

For a detailed list of tools, see page 202

5



Pliers, hammer and chisel set in foam insert

811.1023

For a detailed list of tools, see page 225

P10 workshop tool trolley set with 271 tools for 6 drawers

810.6271



M

BUNDLE PRICE!

6 x M / 271 pcs

1.849,-^{EUR}

810.6271

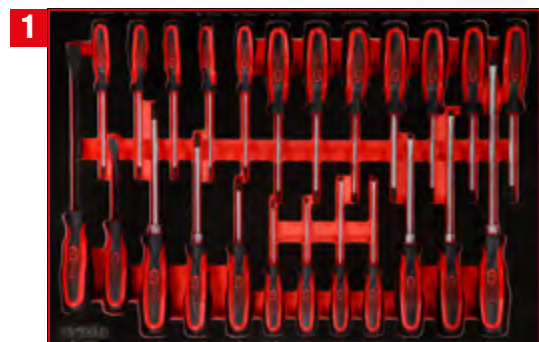

Screwdriver set in foam insert

811.0024

For a detailed list of tools, see page 186



1/4" + 3/8" + 1/2" socket spanner set in foam insert

811.0139

For a detailed list of tools, see page 170



Screw spanner set in foam insert

811.0053

For a detailed list of tools, see page 214



T-handle and screwdriver set in foam insert

811.1022

For a detailed list of tools, see page 194



Spanner set in foam insert

811.0012

For a detailed list of tools, see page 219



Hammer, chisel and file set in foam insert

811.0021

For a detailed list of tools, see page 222

P 10

P 15

P 20

P 25

P 30

P 35

P 40

P 45

Single inserts

Individual parts

Accessories

P10 workshop tool trolley set with 284 tools for 6 drawers

810.6284



M

BUNDLE PRICE!

6 x M / 284 pcs

1.899,-^{EUR}

810.6284

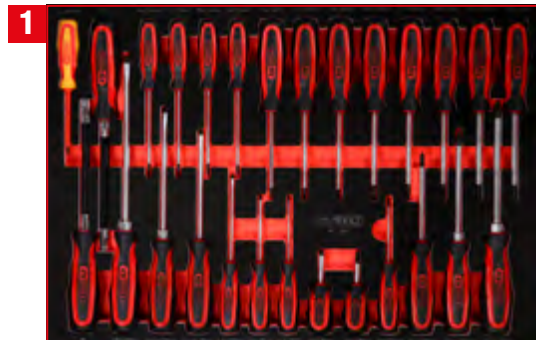

Screwdriver set in foam insert

811.0027

For a detailed list of tools, see page 187

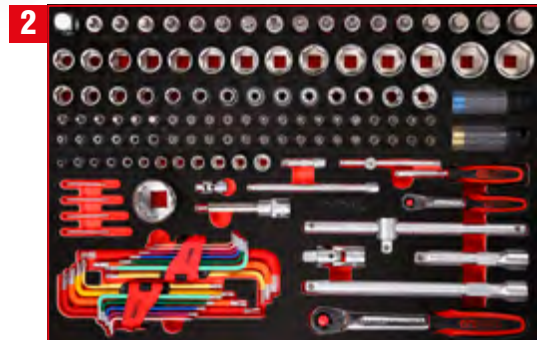

1/4" + 1/2" socket spanner set in foam insert

811.1137

For a detailed list of tools, see page 146



Screw spanner set in foam insert

811.0046

For a detailed list of tools, see page 206

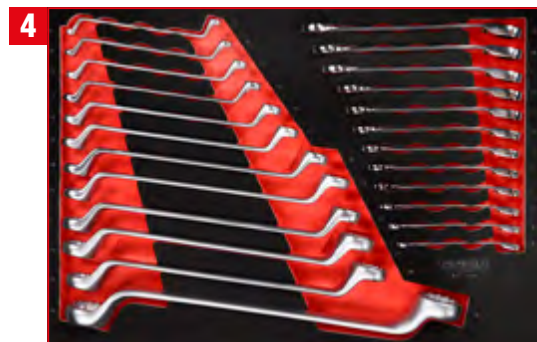

Screw spanner set in foam insert

811.1024

For a detailed list of tools, see page 201



Pliers and file set in foam insert

811.0019

For a detailed list of tools, see page 226

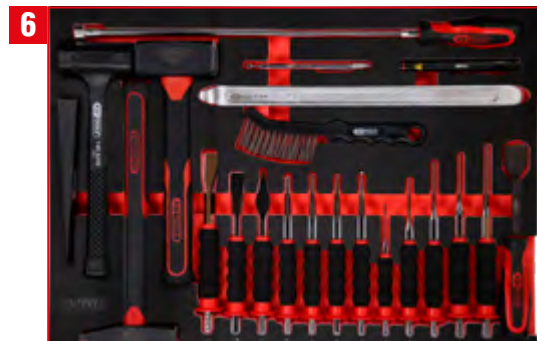

Hammer and chisel set in foam insert

811.0022

For a detailed list of tools, see page 224

P10 workshop tool trolley set with 338 tools for 6 drawers

810.6338

IPCS
338

M

BUNDLE PRICE!

6 x M / 338 pcs

1.899,-^{EUR}

810.6338



IPCS
27

Screwdriver set in foam insert

811.1027

For a detailed list of tools, see page 188



IPCS
142

1/4" + 3/8" socket spanner set in foam insert

811.1142

For a detailed list of tools, see page 140



IPCS
66

1/2" socket spanner set in foam insert

811.0066

For a detailed list of tools, see page 154



IPCS
41

Screw spanner set in foam insert

811.2041

For a detailed list of tools, see page 205

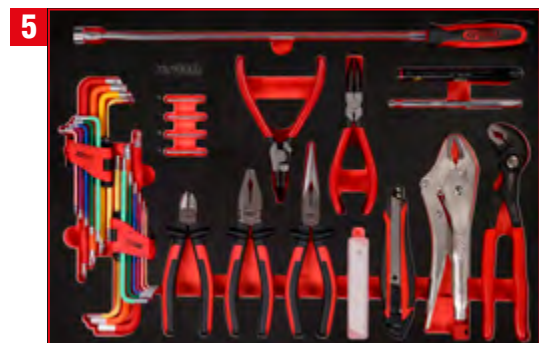

IPCS
45

Pliers and angle spanner set in foam insert

811.0045

For a detailed list of tools, see page 229



IPCS
17

Hammer and chisel set in foam insert

811.1017

For a detailed list of tools, see page 230

P 10

P 15

P 20

P 25

P 30

P 35

P 40

P 45

Single inserts

Individual parts

Accessories

P10 workshop tool trolley set with 366 tools for 6 drawers

810.6366

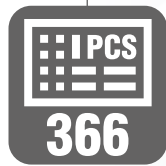

M

BUNDLE PRICE!

6 x M / 366 pcs

1.849,-^{EUR}

810.6366

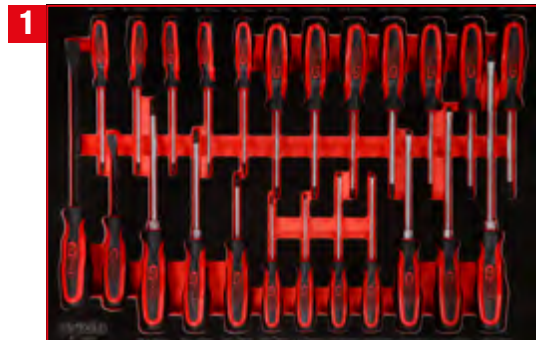

Screwdriver set in foam insert

811.0024

For a detailed list of tools, see page 186

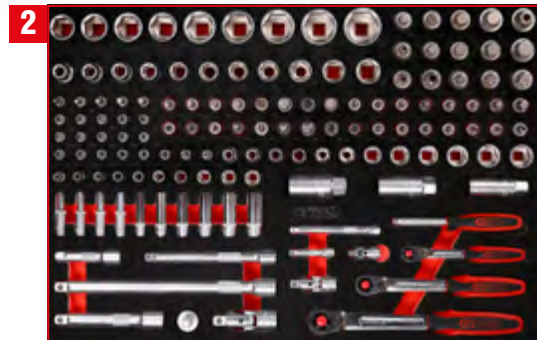

1/4" + 3/8" + 1/2" socket spanner set
in foam insert

811.0139

For a detailed list of tools, see page 170

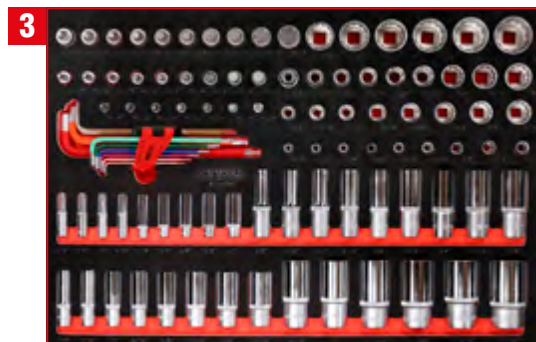

1/4" + 3/8" + 1/2" socket spanner
set in foam insert

811.0099

For a detailed list of tools, see page 176



Screw spanner set in foam insert

811.1040

For a detailed list of tools, see page 203



Screw spanner set in foam insert

811.0031

For a detailed list of tools, see page 218



Pliers, hammer and chisel set in foam
insert

811.0033

For a detailed list of tools, see page 228

P10 workshop tool trolley set with 370 tools for 6 drawers

810.6370



M

BUNDLE PRICE!

6 x M / 370 pcs

2.099,-^{EUR}

810.6370

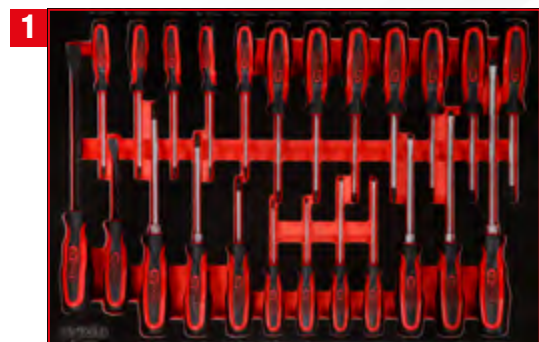

IPCS
24

Screwdriver set in foam insert

811.0024

For a detailed list of tools, see page 186



IPCS
148

1/4" + 3/8" socket spanner set in foam insert

811.0148

For a detailed list of tools, see page 142



IPCS
95

1/2" socket spanner set in foam insert

811.1095

For a detailed list of tools, see page 156



IPCS
53

Screw spanner set in foam insert

811.0053

For a detailed list of tools, see page 214



IPCS
19

Pliers and file set in foam insert

811.0019

For a detailed list of tools, see page 222



IPCS
22

Hammer and chisel set in foam insert

811.0022

For a detailed list of tools, see page 224

P 10

P 15

P 20

P 25

P 30

P 35

P 40

P 45

Single inserts

Individual parts

Accessories

P10 workshop tool trolley set with 399 tools for 6 drawers

810.6399



M

BUNDLE PRICE!

6 x M / 399 pcs

1.899,-^{EUR}

810.6399



IPCS
24

Screwdriver set in foam insert

811.0024

For a detailed list of tools, see page 186

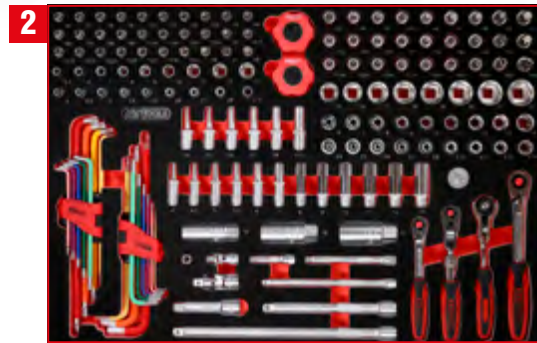

IPCS
156

1/4" + 3/8" socket spanner set
in foam insert

811.0156

For a detailed list of tools, see page 144

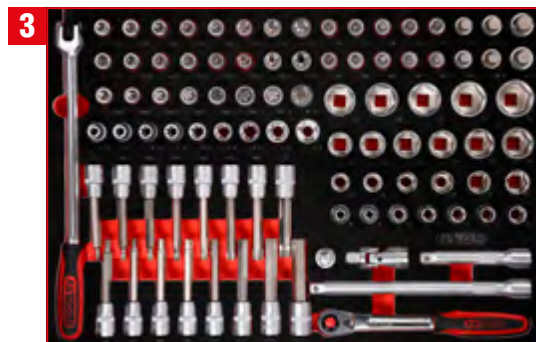

IPCS
95

1/2" socket spanner set in foam insert

811.0095

For a detailed list of tools, see page 158



IPCS
40

Screw spanner set in foam insert

811.1040

For a detailed list of tools, see page 203

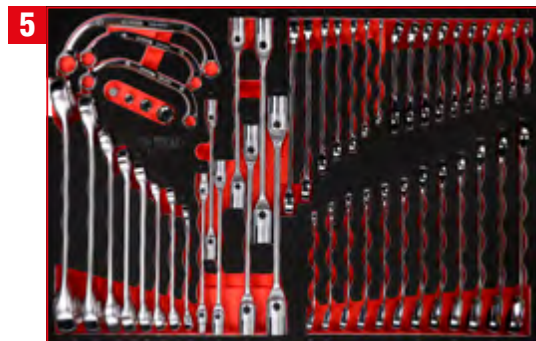

IPCS
51

Screw spanner set in foam insert

811.0051

For a detailed list of tools, see page 212



IPCS
33

Pliers, hammer and chisel set in foam
insert

811.0033

For a detailed list of tools, see page 228

P10 workshop tool trolley set with 423 tools for 6 drawers

810.6423



M

BUNDLE PRICE!

6 x M / 423 pcs

2.099,-^{EUR}

810.6423

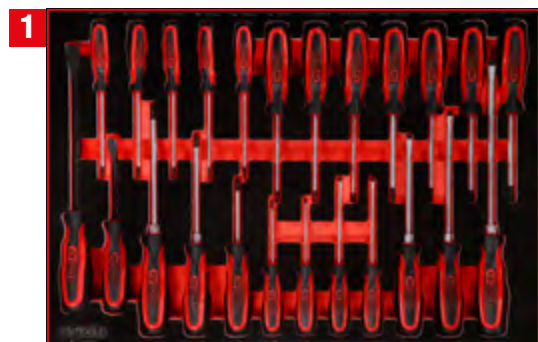

IPCS
24

Screwdriver set in foam insert

811.0024

For a detailed list of tools, see page 186

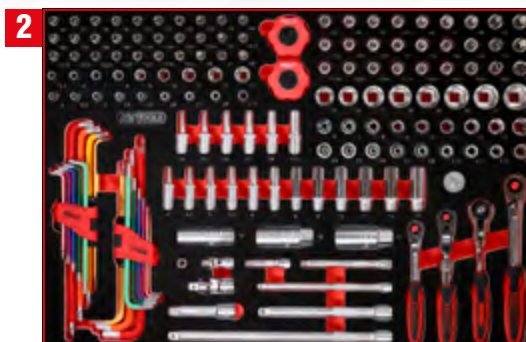

IPCS
156

1/4" + 3/8" socket spanner set in foam insert

811.0156

For a detailed list of tools, see page 144

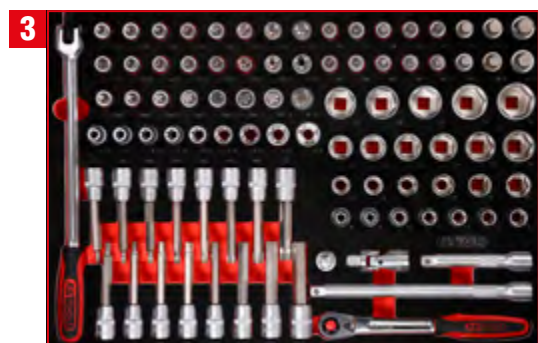

IPCS
95

1/2" socket spanner set in foam insert

811.0095

For a detailed list of tools, see page 158



IPCS
53

Screw spanner set in foam insert

811.0053

For a detailed list of tools, see page 214



IPCS
73

3/8" + 1/2" socket spanner set in foam insert

811.0073

For a detailed list of tools, see page 182



IPCS
22

Pliers, hammer and chisel set in foam insert

811.2022

For a detailed list of tools, see page 223

P 10

P 15

P 20

P 25

P 30

P 35

P 40

P 45

Single inserts

Individual parts

Accessories

P10 workshop tool trolley set with 397 tools for 7 drawers

810.7397



IPCS
397

M

BUNDLE PRICE!

**7 x M
397 pcs**

2.349,-^{EUR}

810.7397

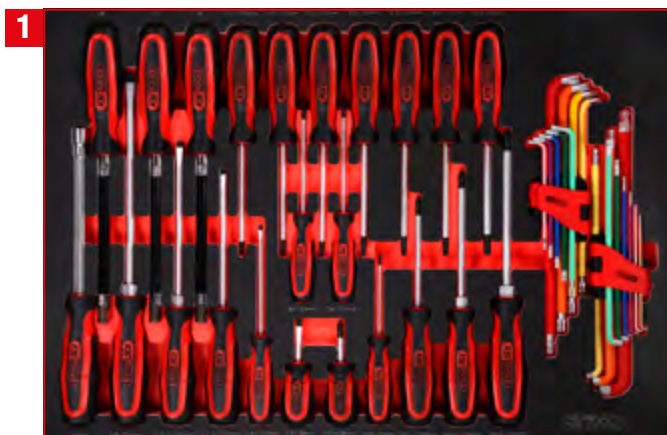

Screw spanner set in foam insert

811.0041

For a detailed list of tools, see page 190

IPCS
41



1/4" + 3/8" + 1/2" socket spanner set in foam insert

811.0111

For a detailed list of tools, see page 168

IPCS
111

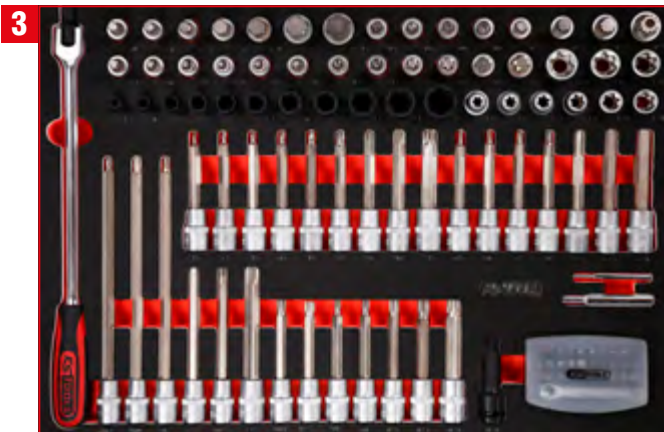

3
1/2" screwdriver bit set
in foam insert

811.1111

For a detailed list of tools, see page 166



4
Screw spanner set in foam
insert

811.1041

For a detailed list of tools, see page 204



5
Pliers and file set in
foam insert

811.0019

For a detailed list of tools, see page 226

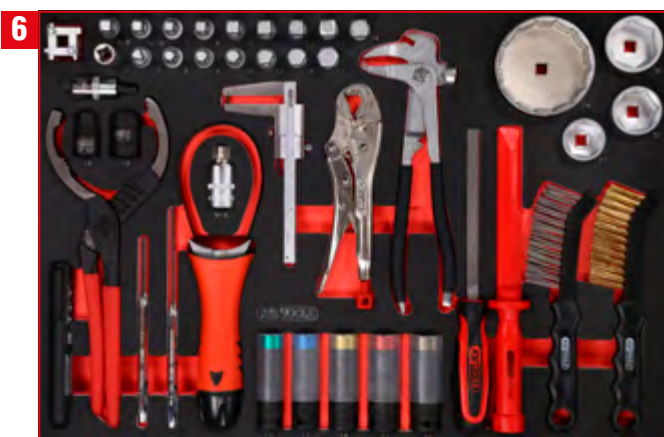

6
Oil and tyre servicing set
in foam insert

811.0043

For a detailed list of tools, see page 232



7
Hammer and chisel set
in foam insert

811.0022

For a detailed list of tools, see page 224



P 10

P 15

P 20

P 25

P 30

P 35

P 40

P 45

Single inserts

Individual parts

Accessories

P10 workshop tool trolley set with 399 tools for 7 drawers

810.7399



IPCS
399

M

BUNDLE PRICE!

**7 x M
399 pcs**

2.049,-^{EUR}

810.7399

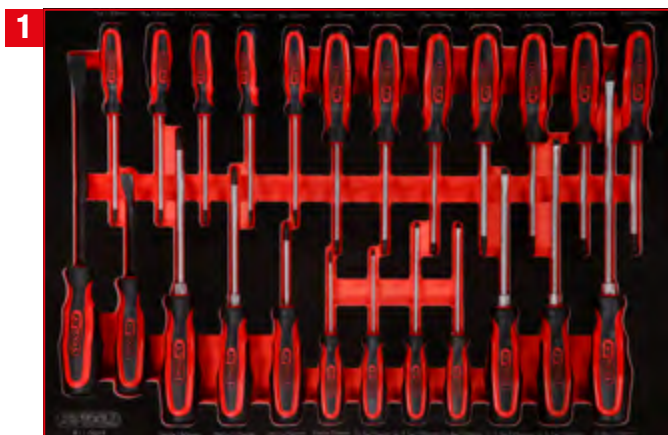

Screwdriver set in foam insert

811.0024

For a detailed list of tools, see page 186

IPCS
24

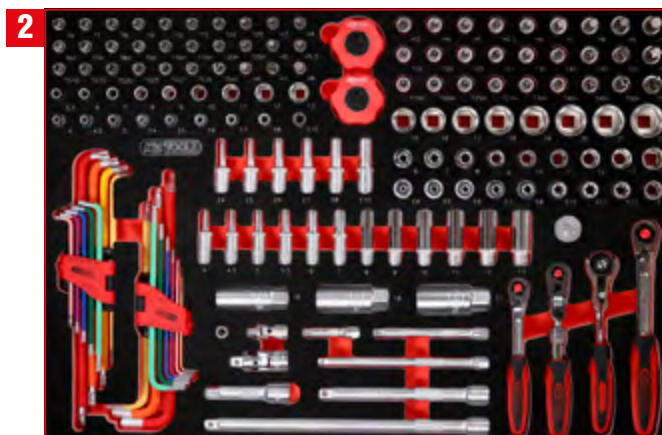

1/4" + 3/8" socket spanner set in foam insert

811.0156

For a detailed list of tools, see page 144

IPCS
156



3
1/2" socket spanner set in foam insert

811.0095

For a detailed list of tools, see page 158



4
Screw spanner set in foam insert

811.1040

For a detailed list of tools, see page 203



5
Screw spanner set in foam insert

811.0051

For a detailed list of tools, see page 212



6
Spanner set in foam insert

811.0012

For a detailed list of tools, see page 219



7
Hammer, chisel and file set in foam insert

811.0021

For a detailed list of tools, see page 222



P10 workshop tool trolley set with 403 tools for 7 drawers

810.7403



403

M

BUNDLE PRICE!

**7 x M
403 pcs**

1.849,-^{EUR}

810.7403

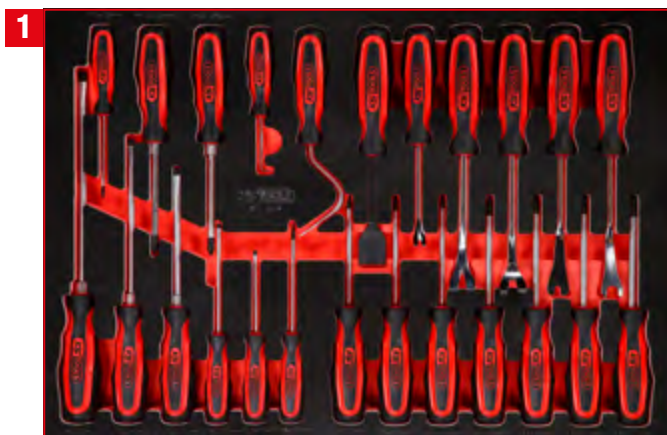

Screwdriver set in
foam insert

811.3024

For a detailed list of tools, see page 192

24

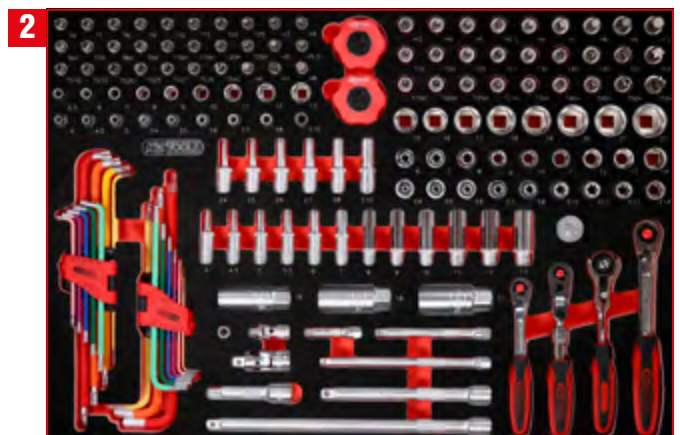

1/4" + 3/8" socket
spanner set in foam insert

811.0156

For a detailed list of tools, see page 144

156

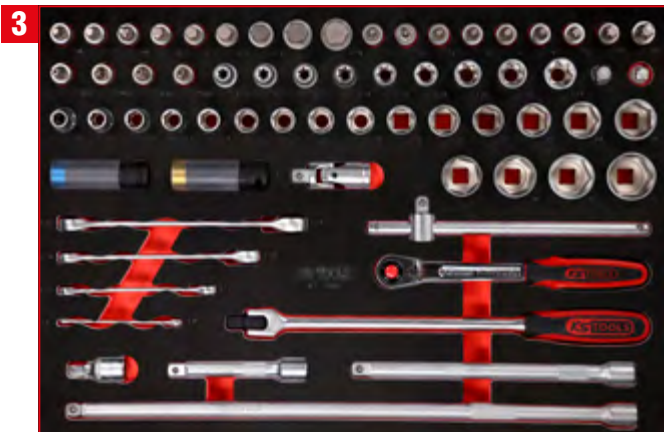

3
1/2" socket spanner set
in foam insert

811.0066

For a detailed list of tools, see page 154



4
1/2" socket spanner /
screwdriver bit set

811.0063

For a detailed list of tools, see page 160



4
Screw spanner set in
foam insert

811.2041

For a detailed list of tools, see page 205



6
Screwdriver and spanner
set in foam insert

811.1032

For a detailed list of tools, see page 227



7
Hammer, chisel and
file set in foam insert

811.0021

For a detailed list of tools, see page 222



P 10

P 15

P 20

P 25

P 30

P 35

P 40

P 45

Single inserts

Individual parts

Accessories

P10 workshop tool trolley set with 536 tools for 8 drawers

810.8536



IPCS
536

M

BUNDLE PRICE!

**8 x M
536 pcs**

2.499,-^{EUR}

810.8536

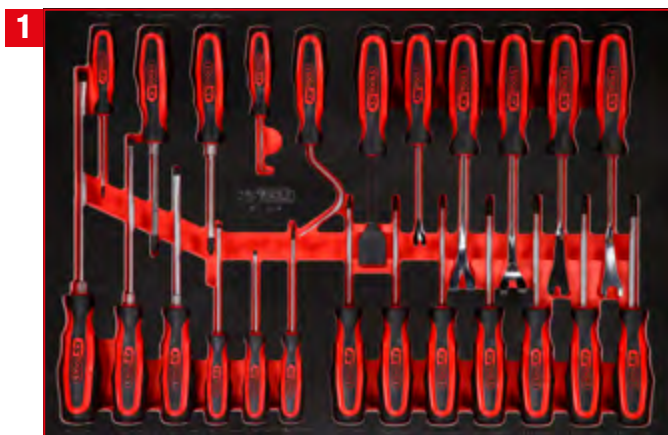

Screwdriver set in foam insert

811.3024

For a detailed list of tools, see page 192

IPCS
24

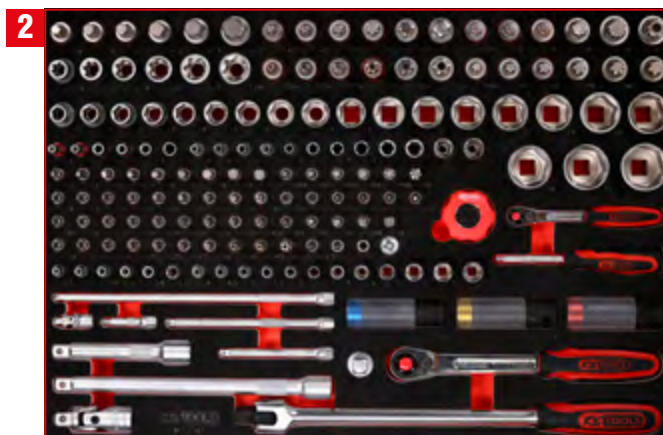

1/4" + 1/2" socket spanner set in foam insert

811.0167

For a detailed list of tools, see page 148

IPCS
167

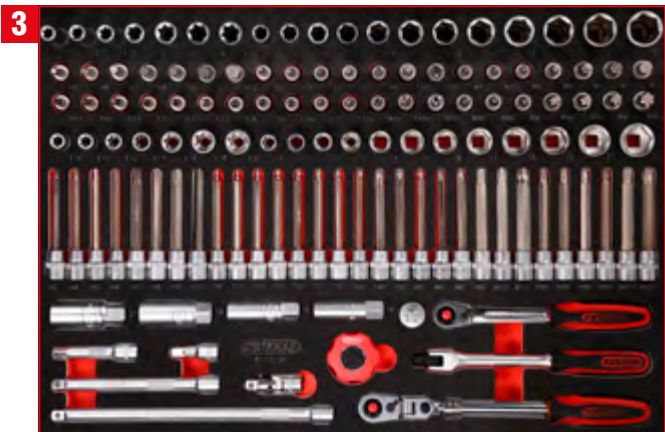

3/8" socket spanner set in foam insert

811.0124

For a detailed list of tools, see page 150

124 PCS



1/2" socket spanner and screwdriver bit set

811.0063

For a detailed list of tools, see page 160

63 PCS



Screw spanner set in foam insert

811.0050

For a detailed list of tools, see page 210

50 PCS

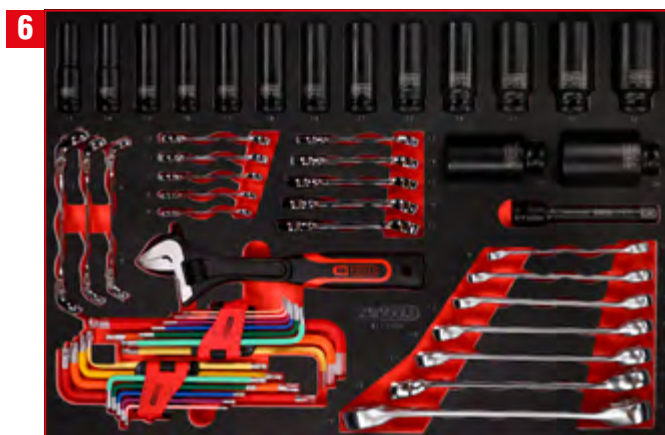

Spanner and impact socket set in foam insert

811.1055

For a detailed list of tools, see page 216

55 PCS



Screwdriver and spanner set in foam insert

811.1032

For a detailed list of tools, see page 227

32 PCS



Hammer, chisel and file set in foam insert

811.0021

For a detailed list of tools, see page 222

21 PCS

P 10

P 15

P 20

P 25

P 30

P 35

P 40

P 45

Single inserts

Individual parts

Accessories

P15 workshop tool trolley set with 241 tools for 4 drawers

815.4241



241
M

BUNDLE PRICE!

**4 x M
180 pcs**

1.549,--^{EUR}
815.4281

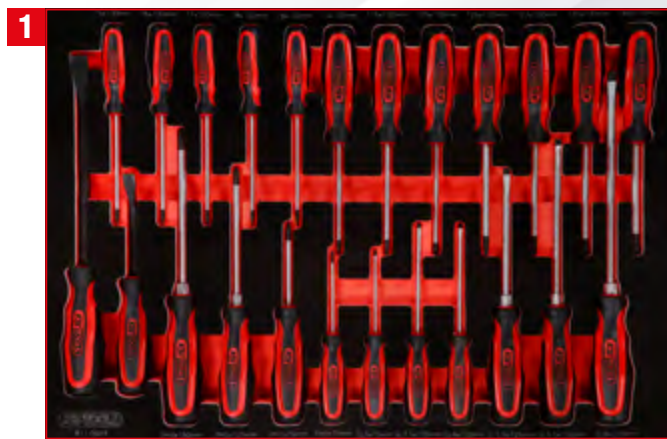

Screwdriver set in foam insert

811.0024

For a detailed list of tools, see page 186

24
IPCS



1/4" + 3/8" + 1/2" socket spanner set in foam insert

811.0159

For a detailed list of tools, see page 172

159
IPCS



Screw spanner set in foam insert

811.1041

For a detailed list of tools, see page 204

41
IPCS



Pliers, hammer and chisel set in foam insert

811.0017

For a detailed list of tools, see page 220

17
IPCS

P15 workshop tool trolley set with 180 tools for 4 drawers

815.4180



180 PCS
180
M

BUNDLE PRICE!

**4 x M
240 pcs**

1.449,-^{EUR}
815.4180

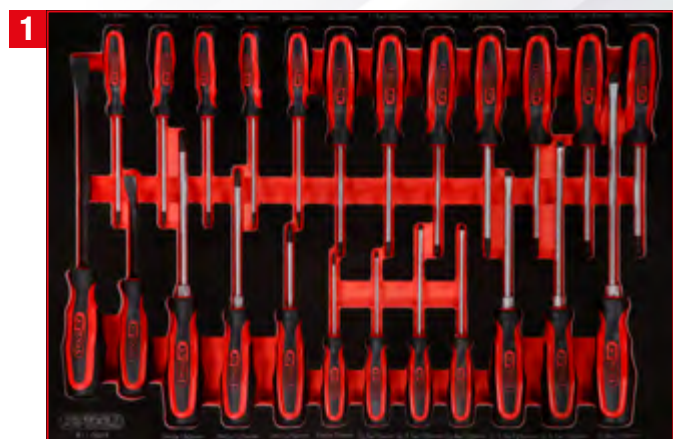

Screwdriver set in foam insert

811.0024

For a detailed list of tools, see page 186

24 PCS
24



1/4" + 3/8" + 1/2" socket spanner set in foam insert

811.0092

For a detailed list of tools, see page 174

92 PCS
92



Screw spanner set in foam insert

811.0031

For a detailed list of tools, see page 218

31 PCS
31



Pliers, hammer and chisel set in foam insert

811.0033

For a detailed list of tools, see page 228

33 PCS
33

P 10
P 15
P 20
P 25
P 30
P 35
P 40
P 45
Single inserts
Individual parts
Accessories

P15 workshop tool trolley set with 262 tools for 5 drawers

815.5262



M

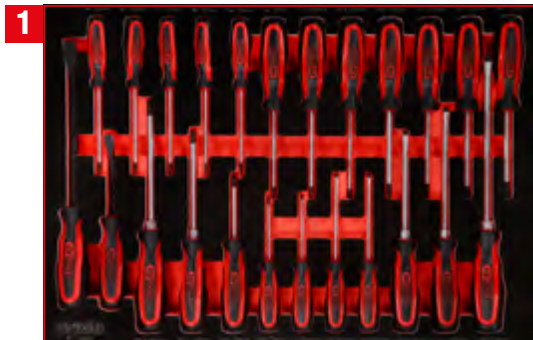

Screwdriver set in foam insert

811.0024

For a detailed list of tools, see page 186



1/4" + 3/8" + 1/2" socket spanner set in foam insert

811.0159

For a detailed list of tools, see page 172



Screw spanner set in foam insert

811.1040

For a detailed list of tools, see page 203

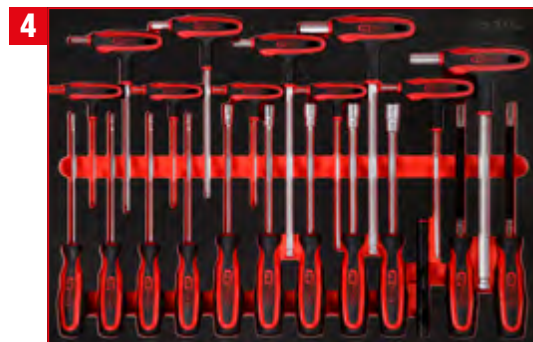

T-handle and screwdriver set in foam insert

811.1022

For a detailed list of tools, see page 194

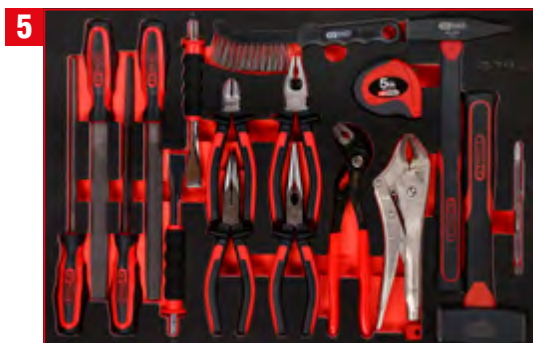

Pliers, hammer and chisel set in foam insert

811.0017

For a detailed list of tools, see page 220

BUNDLE PRICE!

**5 x M
262 pcs**

1.749,-^{EUR}

815.5262

P15 workshop tool trolley set with 279 tools for 5 drawers

815.5279



M

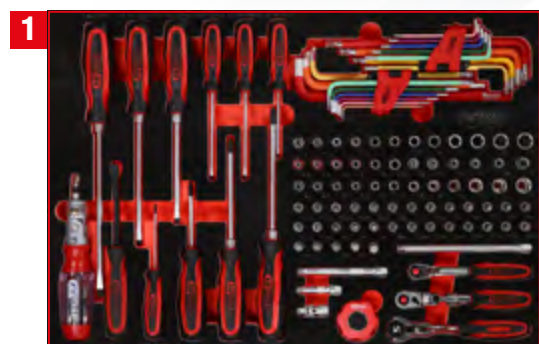

IPCS 105

1/4" socket spanner and screwdriver set in foam insert

811.0105

For a detailed list of tools, see page 134



IPCS 101

3/8" + 1/2" socket spanner set in foam insert

811.0101

For a detailed list of tools, see page 152



IPCS 40

Screw spanner set in foam insert

811.1040

For a detailed list of tools, see page 203



IPCS 12

Spanner set in foam insert

811.0012

For a detailed list of tools, see page 219



IPCS 21

Hammer, chisel and file set in foam insert

811.0021

For a detailed list of tools, see page 222

BUNDLE PRICE!

**5 x M
279 pcs**

1.749,-^{EUR}
815.5279

P 10
P 15
P 20
P 25
P 30
P 35
P 40
P 45
Single inserts
Individual parts
Accessories

P15 workshop tool trolley set with 299 tools for 5 drawers

815.5299



M

BUNDLE PRICE!

5 x M / 299 pcs

1.899,^{EUR}—

815.5299



IPCS
34

Screwdriver set in foam insert

811.0034

For a detailed list of tools, see page 189



IPCS
140

1/4" + 3/8" socket spanner set in foam insert

811.0140

For a detailed list of tools, see page 138



IPCS
64

1/2" screwdriver bit set in foam insert

811.0064

For a detailed list of tools, see page 162



ITLG
38

Screw spanner set in foam insert

811.0038

For a detailed list of tools, see page 202



IPCS
23

Pliers, hammer and chisel set in foam insert

811.1023

For a detailed list of tools, see page 225

P15 workshop tool trolley set with 271 tools for 6 drawers

815.6271



M

BUNDLE PRICE!

6 x M / 271 pcs

1.949,-- EUR

815.6271

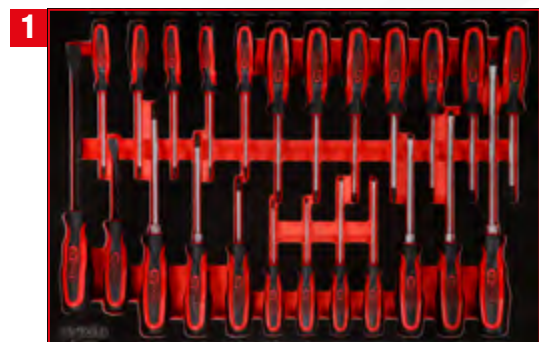

IPCS
24

Screwdriver set in foam insert

811.0024

For a detailed list of tools, see page 186



IPCS
139

1/4" + 3/8" + 1/2" socket spanner set in foam insert

811.0139

For a detailed list of tools, see page 170



IPCS
53

Screw spanner set in foam insert

811.0053

For a detailed list of tools, see page 214



ITLG
22

T-handle and screwdriver set in foam insert

811.1022

For a detailed list of tools, see page 194



IPCS
12

Spanner set in foam insert

811.0012

For a detailed list of tools, see page 219



IPCS
21

Hammer, chisel and file set in foam insert

811.0021

For a detailed list of tools, see page 222

P 10

P 15

P 20

P 25

P 30

P 35

P 40

P 45

Single inserts

Individual parts

Accessories

P15 workshop tool trolley set with 284 tools for 6 drawers

815.6284



M

BUNDLE PRICE!

6 x M / 284 pcs

2.499,--^{EUR}

815.6284

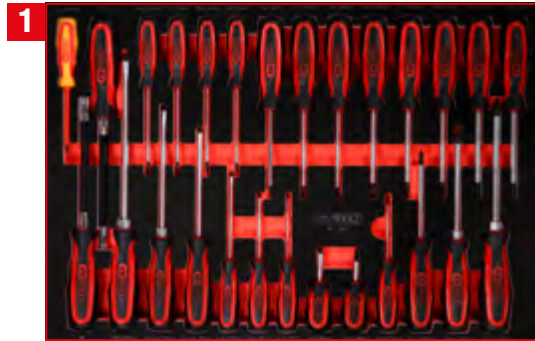

IPCS
27

Screwdriver set in foam insert

811.0027

For a detailed list of tools, see page 187

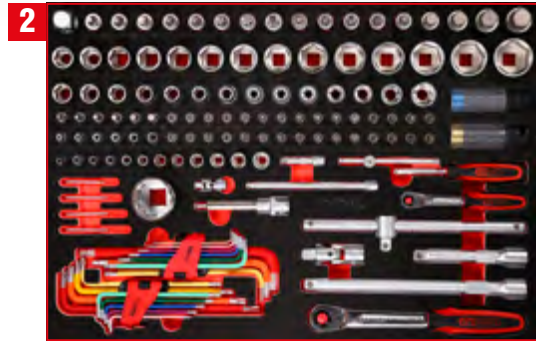

IPCS
137

1/4" + 1/2" socket spanner set in foam insert

811.1137

For a detailed list of tools, see page 146



IPCS
46

Screw spanner set in foam insert

811.0046

For a detailed list of tools, see page 206



IPCS
24

Screw spanner set in foam insert

811.1024

For a detailed list of tools, see page 201



IPCS
19

Pliers and file set in foam insert

811.0019

For a detailed list of tools, see page 226

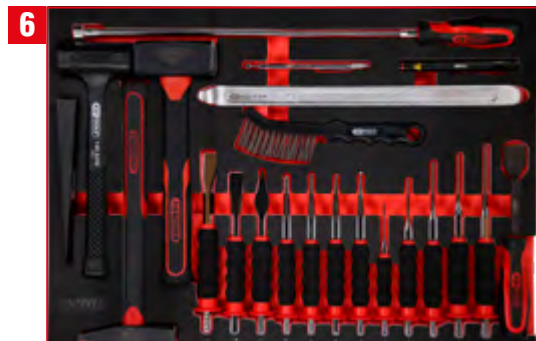

IPCS
22

Hammer and chisel set in foam insert

811.0022

For a detailed list of tools, see page 224

P15 workshop tool trolley set with 338 tools for 6 drawers

815.6338



M

BUNDLE PRICE!

6 x M / 338 pcs

1.999,-- EUR

815.6338



IPCS
27

Screwdriver set in foam insert

811.1027

For a detailed list of tools, see page 188



IPCS
142

1/4" + 3/8" socket spanner set in foam insert

811.1142

For a detailed list of tools, see page 140



IPCS
66

1/2" socket spanner set in foam insert

811.0066

For a detailed list of tools, see page 154



IPCS
41

Screw spanner set in foam insert

811.2041

For a detailed list of tools, see page 205

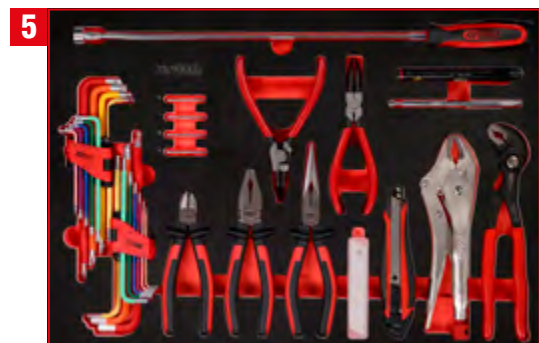

IPCS
45

Pliers and angle spanner set in foam insert

811.0045

For a detailed list of tools, see page 229



IPCS
17

Hammer and chisel set in foam insert

811.1017

For a detailed list of tools, see page 230

P 10
P 15
P 20
P 25
P 30
P 35
P 40
P 45
Single inserts
Individual parts
Accessories

P15 workshop tool trolley set with 366 tools for 6 drawers

815.6366



M

BUNDLE PRICE!

6 x M / 366 pcs

1.949,^{EUR}-

815.6366



IPCS
24

Screwdriver set in foam insert

811.0024

For a detailed list of tools, see page 186

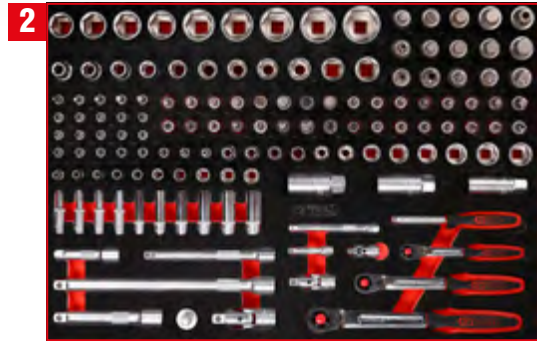

IPCS
139

1/4" + 3/8" + 1/2" socket spanner set in foam insert

811.0139

For a detailed list of tools, see page 170

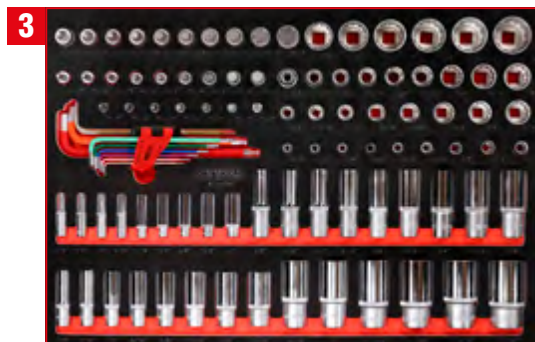

IPCS
99

1/4" + 3/8" + 1/2" socket spanner set in foam insert

811.0099

For a detailed list of tools, see page 176



IPCS
40

Screw spanner set in foam insert

811.1040

For a detailed list of tools, see page 203



IPCS
31

Screw spanner set in foam insert

811.0031

For a detailed list of tools, see page 218



IPCS
33

Pliers, hammer and chisel set in foam insert

811.0033

For a detailed list of tools, see page 228

P15 workshop tool trolley set with 370 tools for 6 drawers

815.6370



M

BUNDLE PRICE!

6 x M / 370 pcs

2.249,-- EUR

815.6370

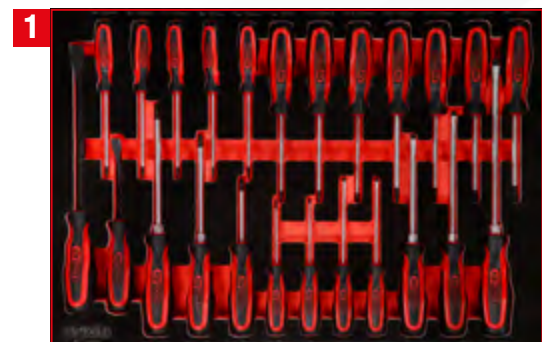

IPCS
24

Screwdriver set in foam insert

811.0024

For a detailed list of tools, see page 186



IPCS
148

1/4" + 3/8" socket spanner set in foam insert

811.0148

For a detailed list of tools, see page 142



IPCS
95

1/2" socket spanner set in foam insert

811.1095

For a detailed list of tools, see page 156



IPCS
53

Screw spanner set in foam insert

811.0053

For a detailed list of tools, see page 214



IPCS
19

Pliers and file set in foam insert

811.0019

For a detailed list of tools, see page 226



IPCS
22

Hammer and chisel set in foam insert

811.0022

For a detailed list of tools, see page 224

P 10
P 15
P 20
P 25
P 30
P 35
P 40
P 45
Single inserts
Individual parts
Accessories

P15 workshop tool trolley set with 399 tools for 6 drawers

815.6399



M

BUNDLE PRICE!

6 x M / 399 pcs

2.049,^{EUR}—

815.6399



IPCS
24

Screwdriver set in foam insert

811.0024

For a detailed list of tools, see page 186

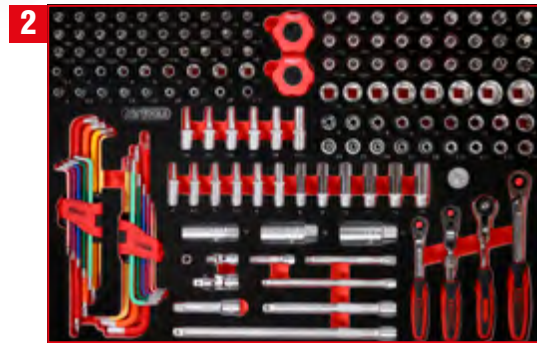

IPCS
156

1/4" + 3/8" socket spanner set in foam insert

811.0156

For a detailed list of tools, see page 144

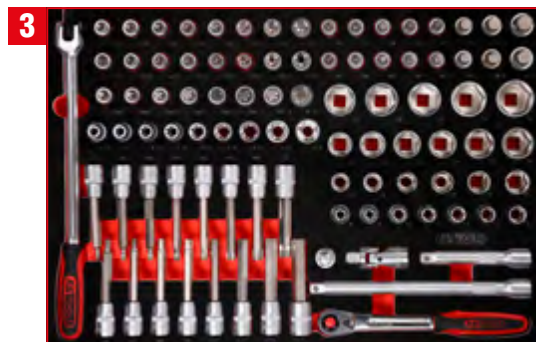

IPCS
95

1/2" socket spanner set in foam insert

811.0095

For a detailed list of tools, see page 158



IPCS
40

Screw spanner set in foam insert

811.1040

For a detailed list of tools, see page 203

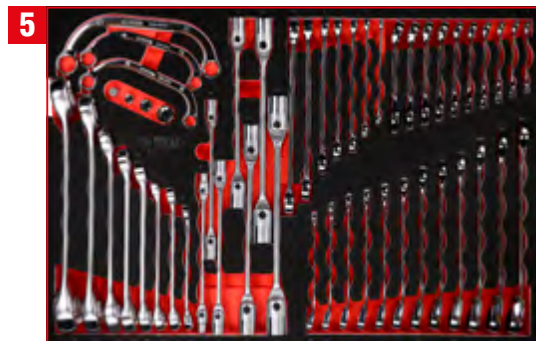

IPCS
51

Screw spanner set in foam insert

811.0051

For a detailed list of tools, see page 212



IPCS
33

Pliers, hammer and chisel set in foam insert

811.0033

For a detailed list of tools, see page 228

P15 workshop tool trolley set with 423 tools for 6 drawers

815.6423



M

BUNDLE PRICE!

6 x M / 423 pcs

2.249,--^{EUR}

815.6423

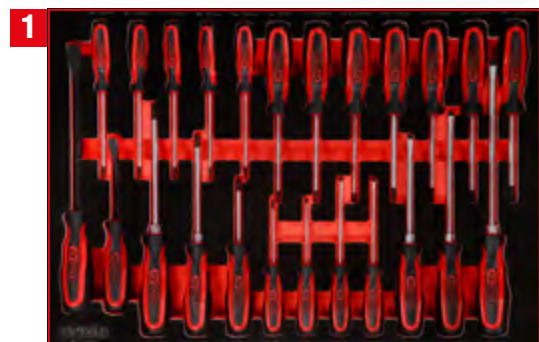

IPCS
24

Screwdriver set in foam insert

811.0024

For a detailed list of tools, see page 186

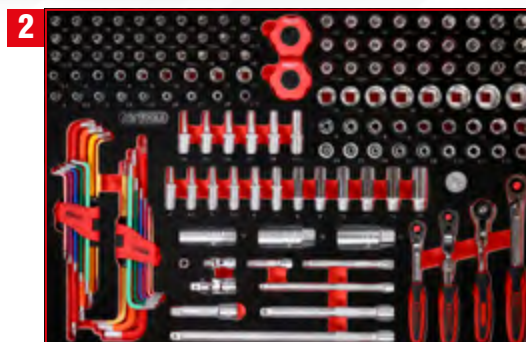

IPCS
156

1/4" + 3/8" socket spanner set in foam insert

811.0156

For a detailed list of tools, see page 144

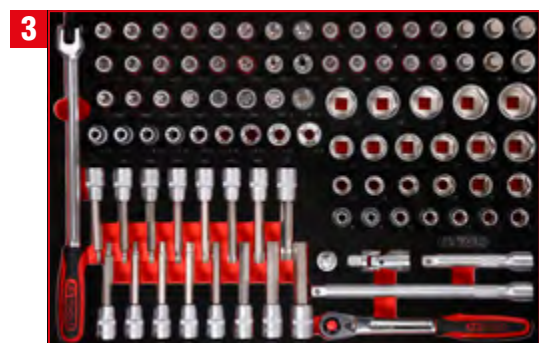

IPCS
95

1/2" socket spanner set in foam insert

811.0095

For a detailed list of tools, see page 158



IPCS
53

Screw spanner set in foam insert

811.0053

For a detailed list of tools, see page 214

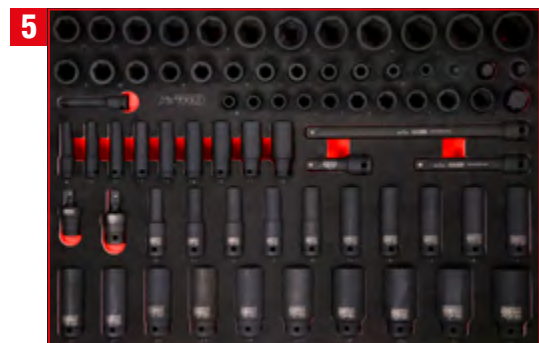

IPCS
73

3/8" + 1/2" socket spanner set in foam insert

811.0073

For a detailed list of tools, see page 182



IPCS
22

Pliers, hammer and chisel set in foam insert

811.2022

For a detailed list of tools, see page 223

P 10

P 15

P 20

P 25

P 30

P 35

P 40

P 45

Single inserts

Individual parts

Accessories

P15 workshop tool trolley set with 397 tools for 7 drawers

815.7397

IPCS
397

M

BUNDLE PRICE!

**7 x M
397 pcs**

2.449,-^{EUR}

815.7397

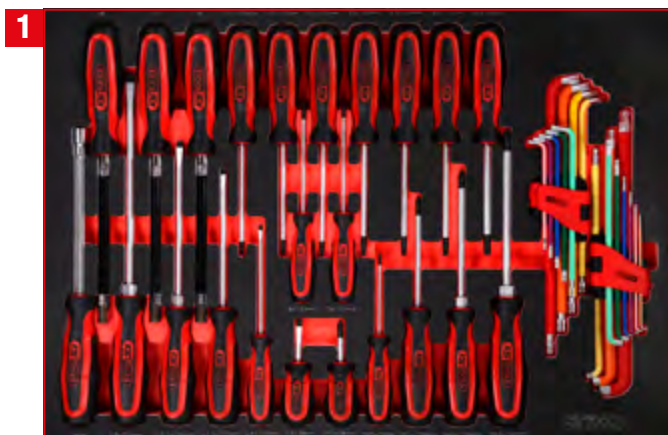

Screw spanner set in foam insert

811.0041

For a detailed list of tools, see page 190

IPCS
41



1/4" + 3/8" + 1/2" socket spanner set in foam insert

811.0111

For a detailed list of tools, see page 168

IPCS
111

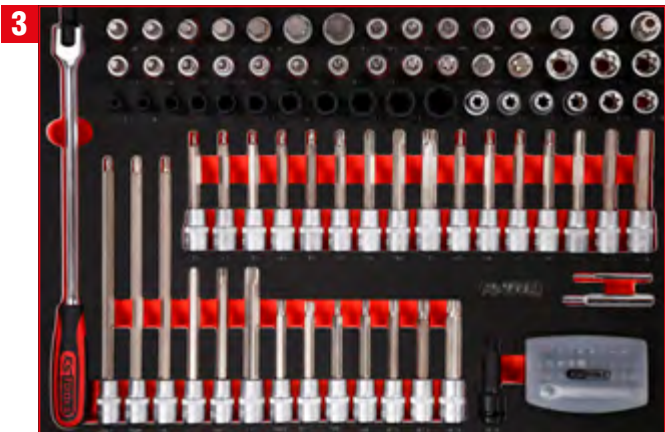

3
1/2" screwdriver bit set
in foam insert

811.1111

For a detailed list of tools, see page 166



4
Screw spanner set in
foam insert

811.1041

For a detailed list of tools, see page 204



Pliers and file set in foam
insert

811.0019

For a detailed list of tools, see page 226

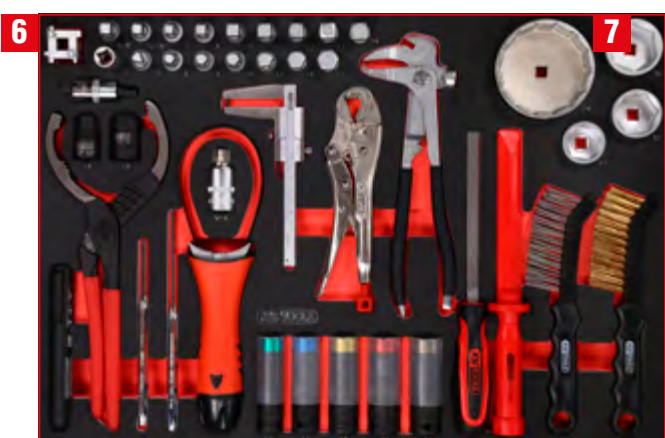

6
Oil and tyre servicing set
in foam insert

811.0043

For a detailed list of tools, see page 232



7
Hammer and chisel set in
foam insert

811.0022

For a detailed list of tools, see page 224



P 10

P 15

P 20

P 25

P 30

P 35

P 40

P 45

Single inserts

Individual parts

Accessories

P15 workshop tool trolley set with 399 tools for 7 drawers

815.7399



M

BUNDLE PRICE!

**7 x M
399 pcs**

2.199,-^{EUR}

815.7399

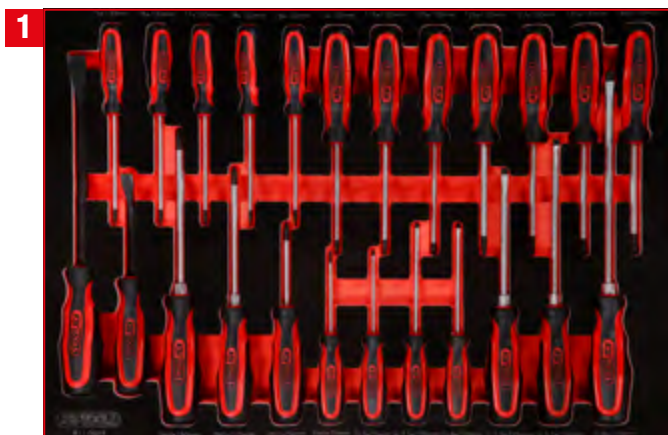

1 Screwdriver set in foam insert

811.0024

For a detailed list of tools, see page 186

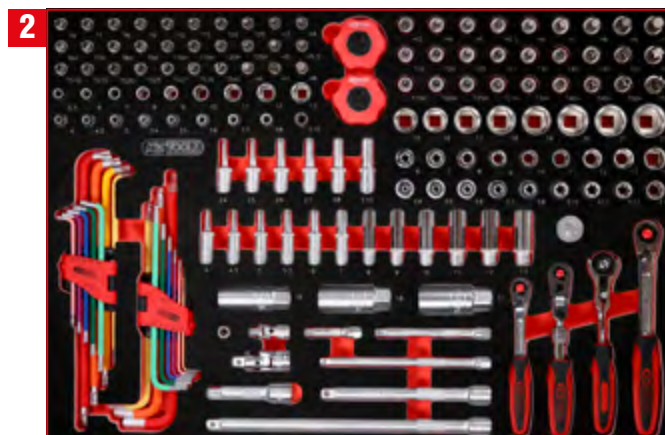

2 1/4" + 3/8" socket spanner set in foam insert

811.0156

For a detailed list of tools, see page 144





3
1/2" socket spanner set in foam insert

811.0095

For a detailed list of tools, see page 158



4
Screw spanner set in foam insert

811.1040

For a detailed list of tools, see page 203



5
Screw spanner set in foam insert

811.0051

For a detailed list of tools, see page 212



6
Spanner set in foam insert

811.0012

For a detailed list of tools, see page 219



7
Hammer, chisel and file set in foam insert

811.0021

For a detailed list of tools, see page 222



P 10

P 15

P 20

P 25

P 30

P 35

P 40

P 45

Single inserts

Individual parts

Accessories

P15 workshop tool trolley set with 403 tools for 7 drawers

815.7403

IPCS
403

M

BUNDLE PRICE!

**7 x M
403 pcs**

1.949,--^{EUR}

815.7403

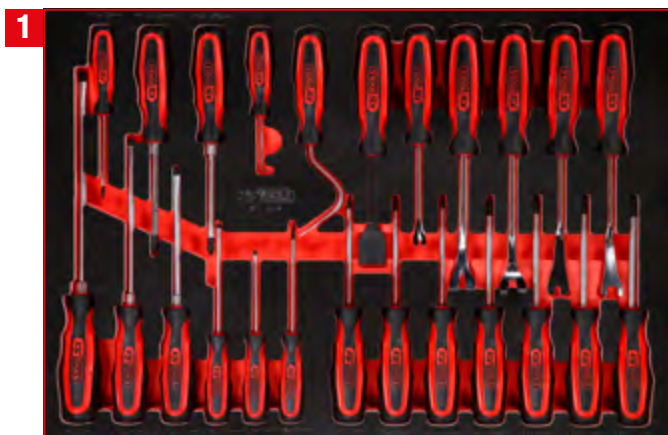

Screwdriver set in foam insert

811.3024

For a detailed list of tools, see page 192

IPCS
24

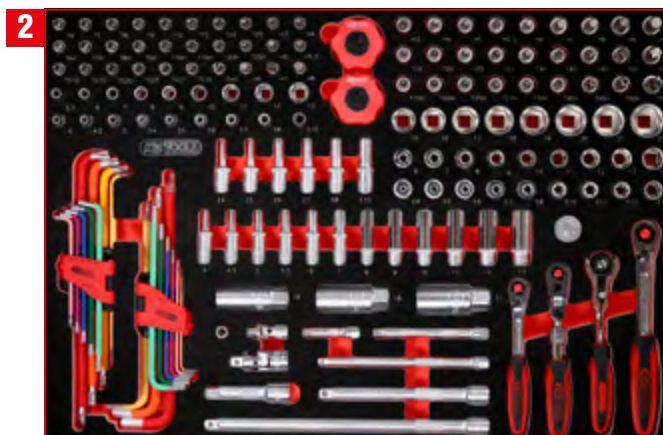

1/4" + 3/8" socket spanner set in foam insert

811.0156

For a detailed list of tools, see page 144

IPCS
156



3
1/2" socket spanner set in foam insert



811.0066

For a detailed list of tools, see page 154

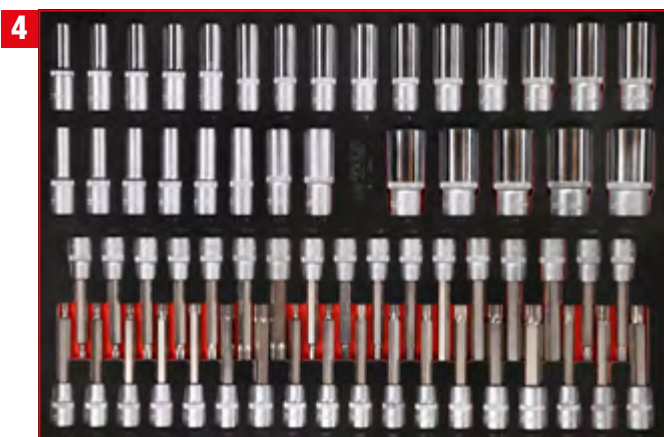

4
1/2" socket spanner and screwdriver bit set



811.0063

For a detailed list of tools, see page 160



5
Screw spanner set in foam insert



811.2041

For a detailed list of tools, see page 205



6
Screwdriver and spanner set in foam insert



811.1032

For a detailed list of tools, see page 227



7
Hammer, chisel and file set in foam insert



811.0021

For a detailed list of tools, see page 222

P 10

P 15

P 20

P 25

P 30

P 35

P 40

P 45

Single inserts

Individual parts

Accessories

P15 workshop tool trolley set with 536 tools for 8 drawers

815.8536

IPCS
536

M

BUNDLE PRICE!

**8 x M
536 pcs**

2.649,-^{EUR}

815.8536

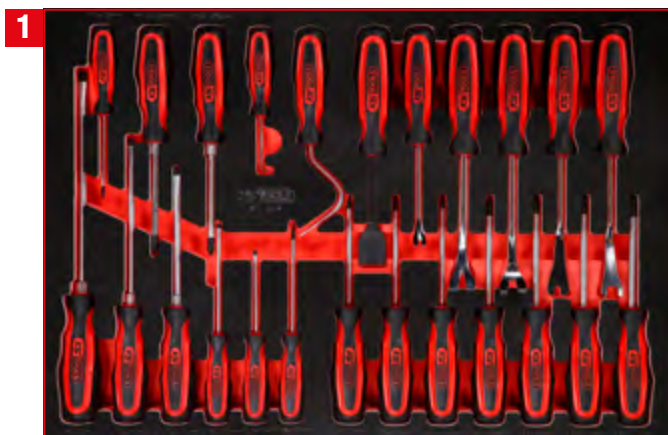

Screwdriver set in foam insert

811.3024

For a detailed list of tools, see page 192

IPCS
24

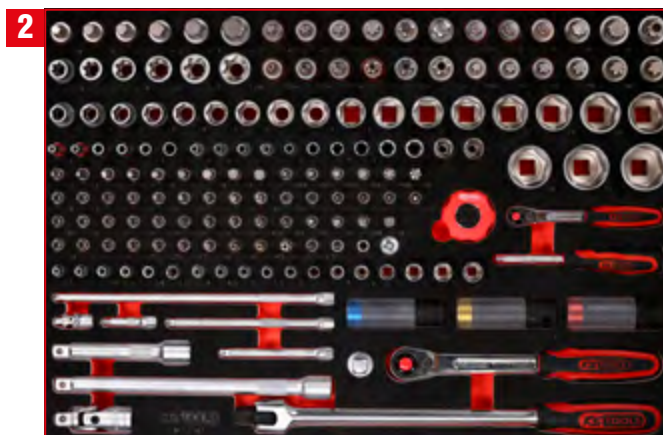

1/4" + 1/2" socket spanner set in foam insert

811.0167

For a detailed list of tools, see page 148

IPCS
167

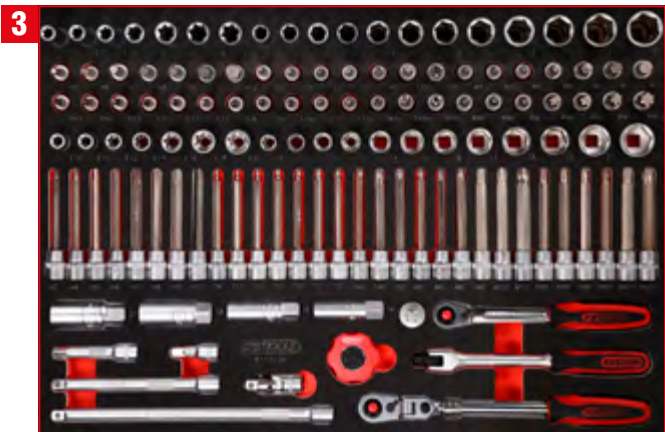

3/8" socket spanner set in foam insert

811.0124

For a detailed list of tools, see page 150

124 PCS



1/2" socket spanner and screwdriver bit set

811.0063

For a detailed list of tools, see page 160

63 PCS



Screw spanner set in foam insert

811.0050

For a detailed list of tools, see page 210

50 PCS



Spanner and impact socket set in foam insert

811.1055

For a detailed list of tools, see page 216

55 PCS



Screwdriver and spanner set in foam insert

811.1032

For a detailed list of tools, see page 227

32 PCS



Hammer, chisel and file set in foam insert

811.0021

For a detailed list of tools, see page 222

21 PCS

P20 workshop tool trolley set with 706 tools for 7 drawers

820.9706



706

M

5 6 8 9

XL

1 2 3 4 7

BUNDLE PRICE!

**4 x M, 5 x XL
706 pcs**

3.999, ^{EUR}—
820.9706

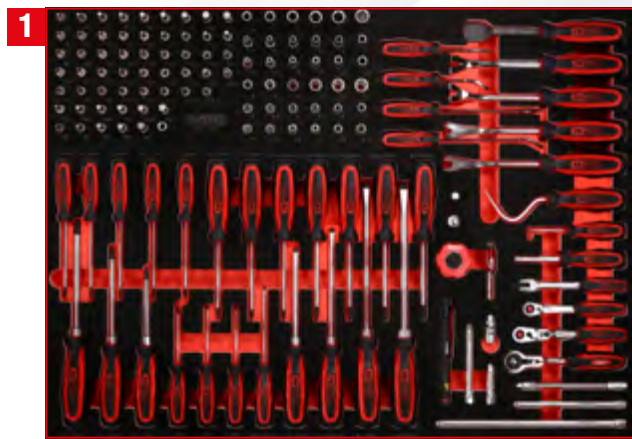

1/4" socket spanner and
screwdriver set

821.0142

For a detailed list of tools, see page 276

142

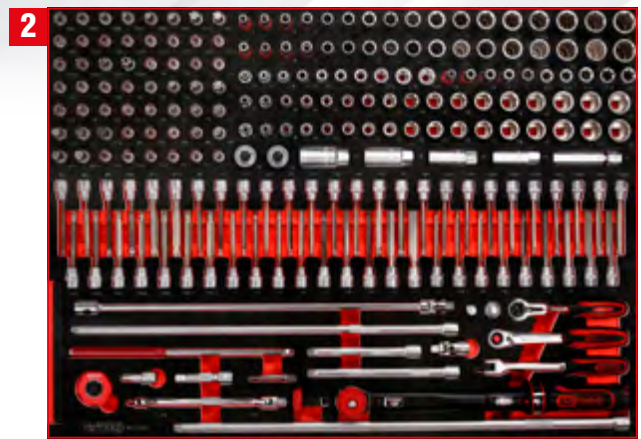

3/8" socket spanner set
in foam insert

821.0221

For a detailed list of tools, see page 278

221



1/2" socket spanner set
in foam insert

821.0149

For a detailed list of tools, see page 280

149



Screw spanner set in
foam insert

821.0076

For a detailed list of tools, see page 286

76

5

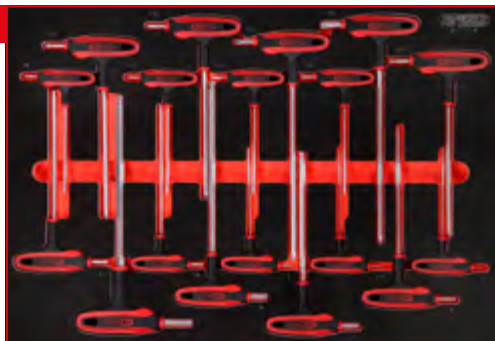

18
IPCS

T-handle angle spanner set in foam insert

811.1018

For a detailed list of tools, see page 195

6



18
IPCS

T-handle angle spanner set in foam insert

811.2018

For a detailed list of tools, see page 193

7



34
IPCS

Spanner set in foam insert

821.0034

For a detailed list of tools, see page 288

8



20
IPCS

Hammer and chisel set in foam insert

811.0020

For a detailed list of tools, see page 221

9



28
IPCS

Measuring tool and file set in foam insert

811.0028

For a detailed list of tools, see page 234

P 10

P 15

P 20

P 25

P 30

P 35

P 40

P 45

Single inserts

Individual parts

Accessories

P25 workshop tool trolley set with 285 tools for 4 drawers

825.4285



IPCS
285

L

BUNDLE PRICE!

**4 x L
285 pcs**

1.949,--^{EUR}
825.4285



IPCS
30

Pliers and measuring tool set in foam insert

813.0030

For a detailed list of tools, see page 274

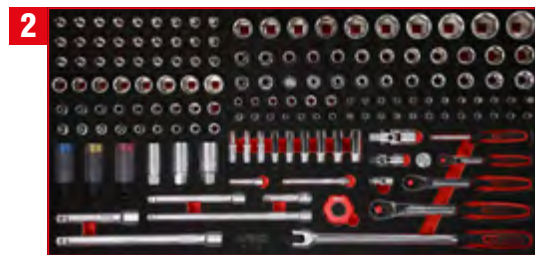

IPCS
156

1/4" + 3/8" + 1/2" socket spanner set in foam insert

813.0156

For a detailed list of tools, see page 252



IPCS
57

Screw spanner set in foam insert

813.0057

For a detailed list of tools, see page 268

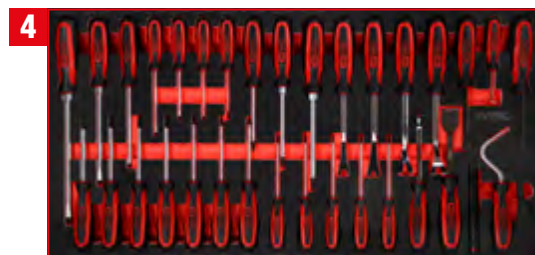

IPCS
33

Screwdriver set in foam insert

813.0033

For a detailed list of tools, see page 254

P25 workshop tool trolley set with 416 tools for 6 drawers

825.6416



BUNDLE PRICE!

6 x L / 416 pcs

2.699, ^{EUR}-

825.6416



Screwdriver set in foam insert

813.1033

For a detailed list of tools, see page 255

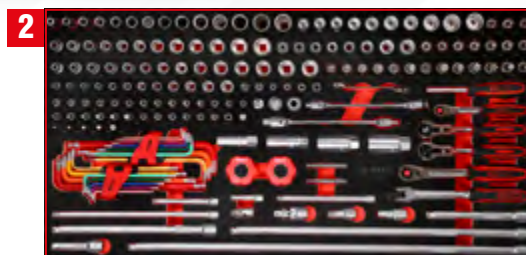

1/4" + 3/8" socket spanner set in foam insert

813.0183

For a detailed list of tools, see page 238

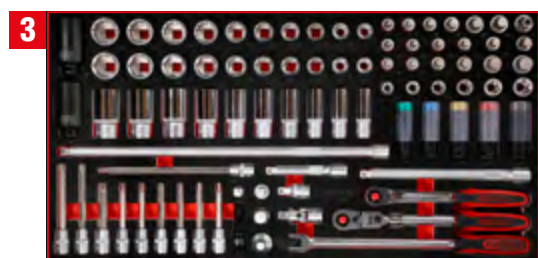

1/2" socket spanner set in foam insert

813.0085

For a detailed list of tools, see page 45244

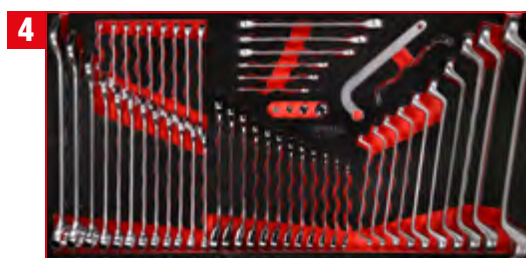

Screw spanner set in foam insert

813.0055

For a detailed list of tools, see page 264

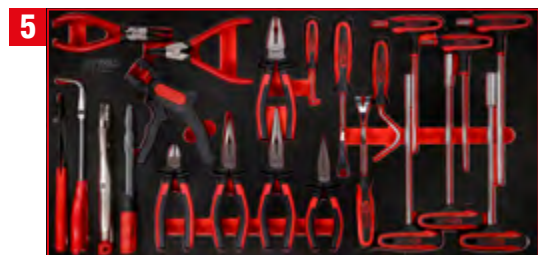

T-handle angle wrench and screwdriver set in foam insert

813.0024

For a detailed list of tools, see page 270



Hammer, chisel and measuring tool set in foam insert

813.1036

For a detailed list of tools, see page 271

P 10
P 15
P 20
P 25
P 30
P 35
P 40
P 45
Single inserts
Individual parts
Accessories

P25 workshop tool trolley set with 446 tools for 6 drawers

825.6446



BUNDLE PRICE!

6 x L / 446 pcs

2.649,-^{EUR}

825.6446



Screwdriver set in foam insert

813.1033

For a detailed list of tools, see page 255

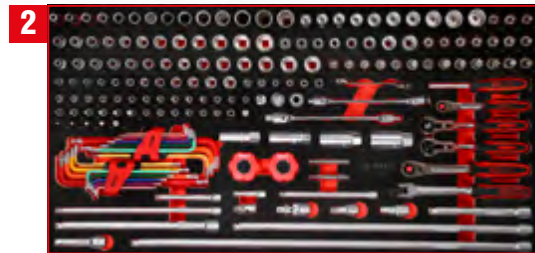

1/4" + 3/8" socket spanner set in foam insert

813.0183

For a detailed list of tools, see page 238



1/2" socket spanner set in foam insert

813.0117

For a detailed list of tools, see page 248

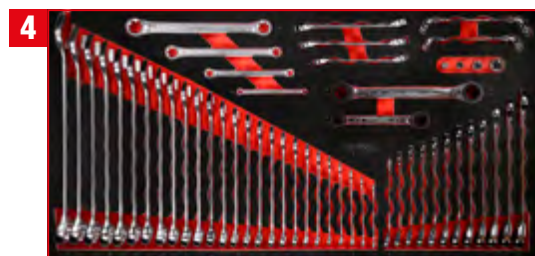

Screw spanner set in foam insert

813.0053

For a detailed list of tools, see page 260

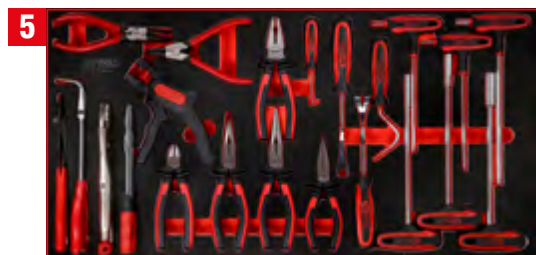

T-handle angle wrench and screwdriver set in foam insert

813.0024

For a detailed list of tools, see page 270

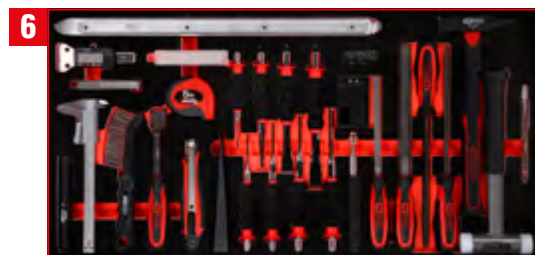

Hammer, chisel and measuring tool set in foam insert

813.1036

For a detailed list of tools, see page 271



P 10

P 15

P 20

P 25

P 30

P 35

P 40

P 45

Single inserts

Individual parts

Accessories

P25 workshop tool trolley set with 510 tools for 7 drawers

825.7510



PCS
510

L

BUNDLE PRICE!

**7 x L
510 pcs**

2.899,-^{EUR}

825.7510

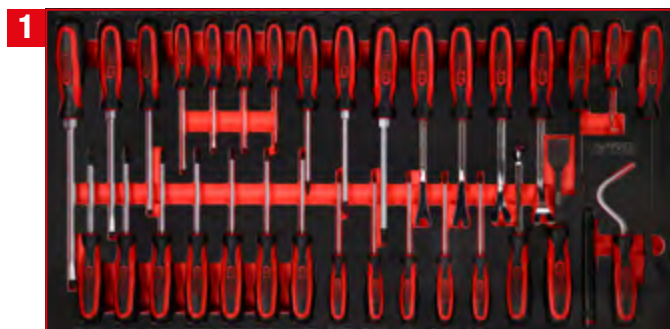

Screwdriver set in foam
insert

813.0033

For a detailed list of tools, see page 254

PCS
33



1/4" + 3/8" socket spanner
set in foam insert

813.0213

For a detailed list of tools, see page 240

PCS
213



3 1/2" socket spanner set in foam insert

813.0086

For a detailed list of tools, see page 246



4 Screw spanner set in foam insert

813.0057

For a detailed list of tools, see page 266



5 Screwdriver and file set in foam insert

813.0042

For a detailed list of tools, see page 258

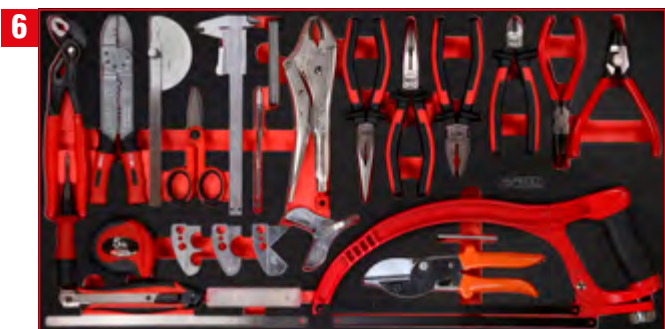

6 Pliers and measuring tool set in foam insert

813.0030

For a detailed list of tools, see page 274



7 Hammer, chisel and impact socket set in foam insert

813.0040

For a detailed list of tools, see page 272



P 10

P 15

P 20

P 25

P 30

P 35

P 40

P 45

Single inserts

Individual parts

Accessories

P25 workshop tool trolley set with 564 tools for 8 drawers

825.8564



PCS
564

L

BUNDLE PRICE!

**8 x L
564 pcs**

3.099,--^{EUR}

825.8564

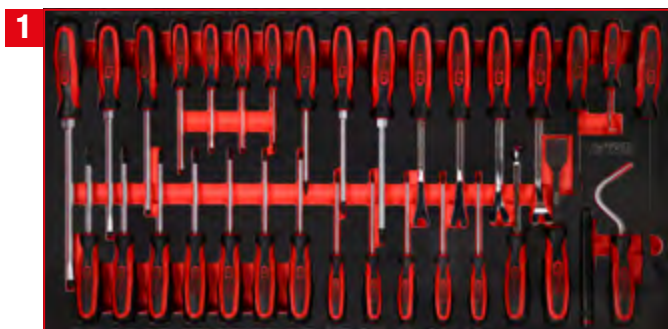

Screwdriver set in foam
insert

813.0033

For a detailed list of tools, see page 254

PCS
33



1/4" + 3/8" socket spanner
set in foam insert

813.0213

For a detailed list of tools, see page 240

PCS
213



3 1/2" socket spanner set in foam insert

813.0086

For a detailed list of tools, see page 246



4 Screw spanner set in foam insert

813.0057

For a detailed list of tools, see page 266

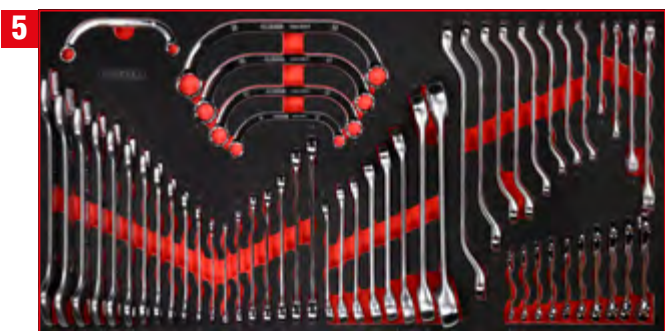

5 Screw spanner set in foam insert

813.0054

For a detailed list of tools, see page 262



6 Screwdriver and file set in foam insert

813.0042

For a detailed list of tools, see page 256

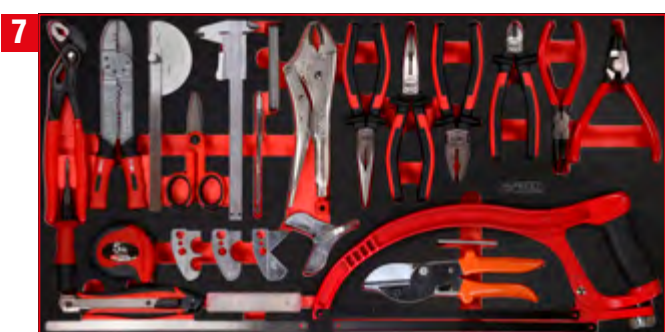

7 Pliers and measuring tool set in foam insert

813.0030

For a detailed list of tools, see page 274



8 Hammer, chisel and impact socket set in foam insert

813.0040

For a detailed list of tools, see page 272



P 10

P 15

P 20

P 25

P 30

P 35

P 40

P 45

Single inserts

Individual parts

Accessories

P25 workshop tool trolley set with 660 tools for 8 drawers

825.8660



IPCS
660

L

BUNDLE PRICE!

**8 x L
660 pcs**

3.449,--^{EUR}

825.8660



Screw spanner set in
foam insert

813.0057

For a detailed list of tools, see page 266

IPCS
57

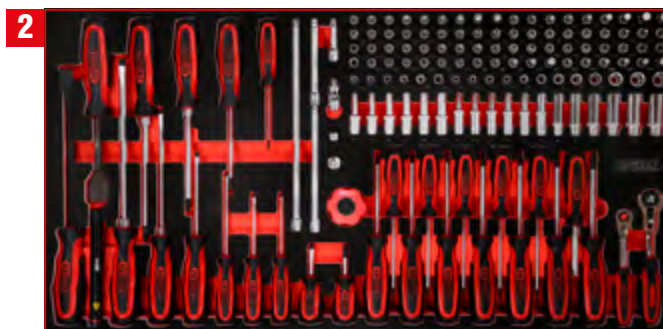

1/4" socket spanner and
screwdriver set

813.0146

For a detailed list of tools, see page 236

IPCS
146



3/8" socket spanner set in foam insert

813.0165

For a detailed list of tools, see page 242

165 PCS



1/2" socket spanner set in foam insert

813.0120

For a detailed list of tools, see page 250

120 PCS



Screw spanner set in foam insert

813.0068

For a detailed list of tools, see page 268

68 PCS



T-handle angle spanner and file set in foam insert

813.0028

For a detailed list of tools, see page 258

28 PCS



Pliers and measuring tool set in foam insert

813.0036

For a detailed list of tools, see page 273

36 PCS



Hammer, chisel and impact socket set in foam insert

813.0040

For a detailed list of tools, see page 272

40 PCS

P 10

P 15

P 20

P 25

P 30

P 35

P 40

P 45

Single inserts

Individual parts

Accessories

P30 workshop tool trolley set with 706 tools for 7 drawers

830.9706



IPCS
706

M

5 6 8 9

XL

1 2 3 4 7

BUNDLE PRICE!

**4 x M, 5 x XL
706 pcs**

4.249,--^{EUR}

830.9706

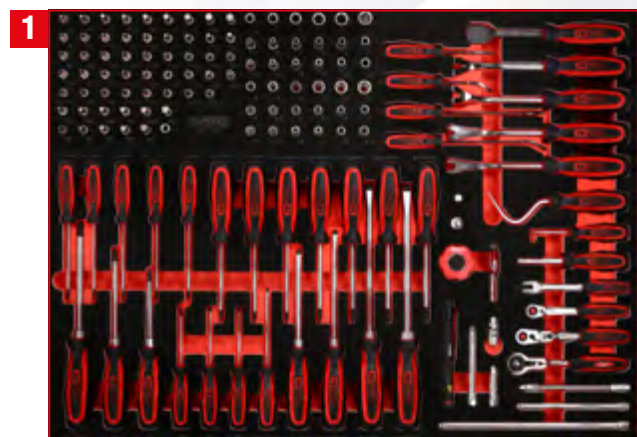

1/4" socket spanner and
screwdriver set

821.0142

For a detailed list of tools, see page 276

IPCS
142

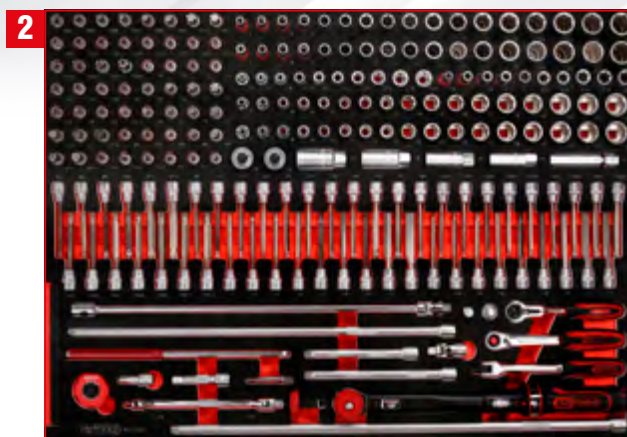

3/8" socket spanner set
in foam insert

821.0221

For a detailed list of tools, see page 278

IPCS
221



1/2" socket spanner set
in foam insert

821.0149

For a detailed list of tools, see page 280

IPCS
149



Screw spanner set in
foam insert

821.0076

For a detailed list of tools, see page 286

IPCS
76

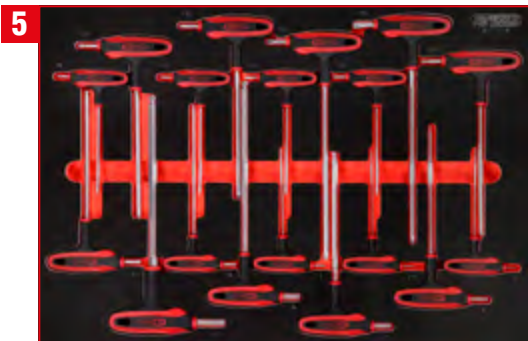

IPCS
18

T-handle angle spanner set in foam insert

811.1018

For a detailed list of tools, see page 195



IPCS
18

T-handle angle spanner set in foam insert

811.2018

For a detailed list of tools, see page 193



IPCS
34

Spanner set in foam insert

821.0034

For a detailed list of tools, see page 288



IPCS
20

Hammer and chisel set in foam insert

811.0020

For a detailed list of tools, see page 221



IPCS
28

Measuring tool and file set in foam insert

811.0028

For a detailed list of tools, see page 234

P35 workshop tool trolley set with 279 tools for 5 drawers

835.5279



M

BUNDLE PRICE!

5 x M / 279 pcs

2.549,--^{EUR}

835.5279

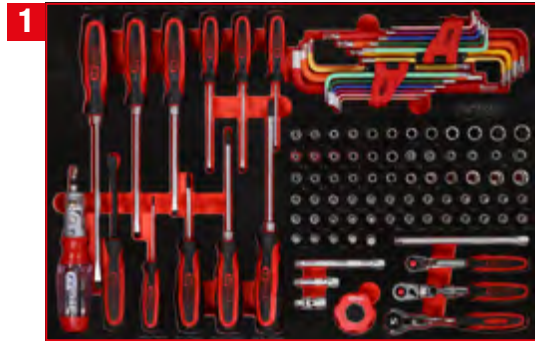

1/4" socket spanner and screwdriver set in foam insert

811.0105

For a detailed list of tools, see page 198



3/8" + 1/2" socket spanner set in foam insert

811.0101

For a detailed list of tools, see page 152



Screw spanner set in foam insert

811.1040

For a detailed list of tools, see page 203



Spanner set in foam insert

811.0012

For a detailed list of tools, see page 219



Hammer, chisel and file set in foam insert

811.0021

For a detailed list of tools, see page 222



P 10

P 15

P 20

P 25

P 30

P 35

P 40

P 45

Single inserts

Individual parts

Accessories

P35 workshop tool trolley set with 549 tools for 12 drawers

835.12549



1	2	3	4	5
6	7	10	11	12
8	9			

BUNDLE PRICE!
10 x M, 2 x S
549 pcs
4.149,= EUR
835.12549

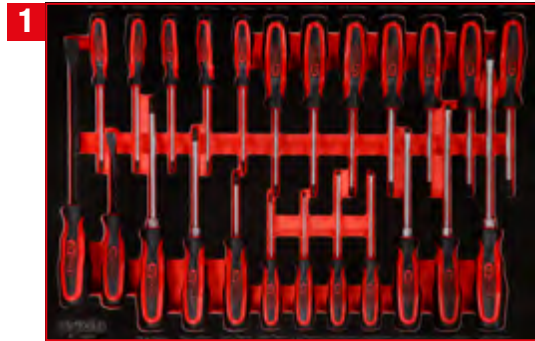

Screwdriver set in foam insert

811.0024

For a detailed list of tools, see page 186

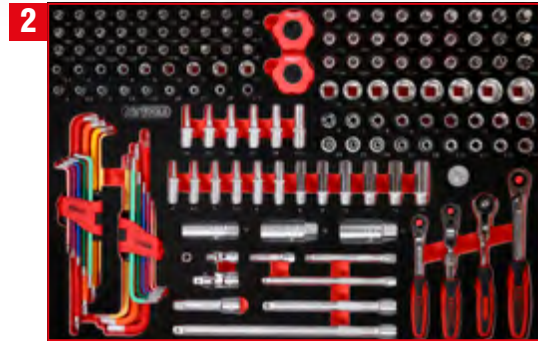

1/4" + 3/8" socket spanner set in foam insert

811.0156

For a detailed list of tools, see page 144

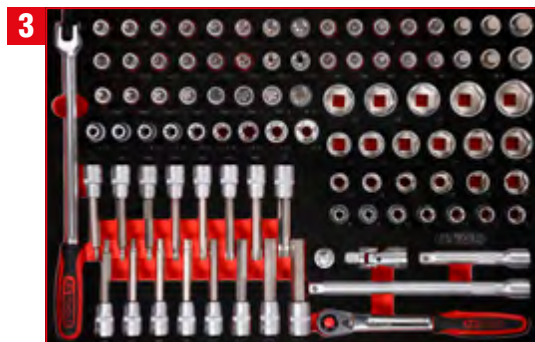

1/2" socket spanner set in foam insert

811.0095

For a detailed list of tools, see page 158



Combination spanner set in foam insert

811.0030

For a detailed list of tools, see page 200

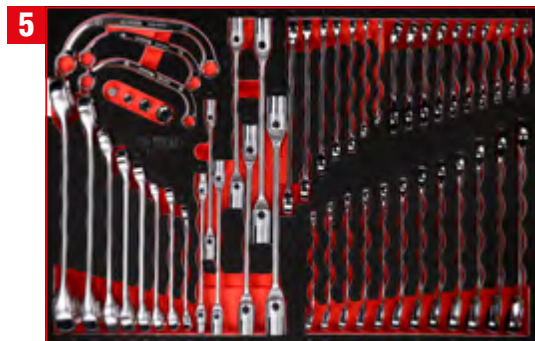

Screw spanner set in foam insert

811.0051

For a detailed list of tools, see page 212



T-handle and screwdriver set in foam insert

811.1022

For a detailed list of tools, see page 194



Hammer, chisel and file set in foam insert

811.0021

For a detailed list of tools, see page 222



Spanner set in foam insert

811.0007

For a detailed list of tools, see page 291



Spanner set in foam insert

812.0005

For a detailed list of tools, see page 290



3/8" + 1/2" socket spanner set in foam insert

811.0073

For a detailed list of tools, see page 182



3/4" socket spanner set in foam insert

811.0032

For a detailed list of tools, see page 178



3/4" impact socket set in foam insert

811.1033

For a detailed list of tools, see page 185

P45 workshop tool trolley set

with 706 tools for 7 drawers

845.9706

706

M

6 7 8 9

XL

1 2 3 4 5



BUNDLE PRICE!

**4 x M, 5 x XL
706 pcs**

5.599,-^{EUR}

845.9706

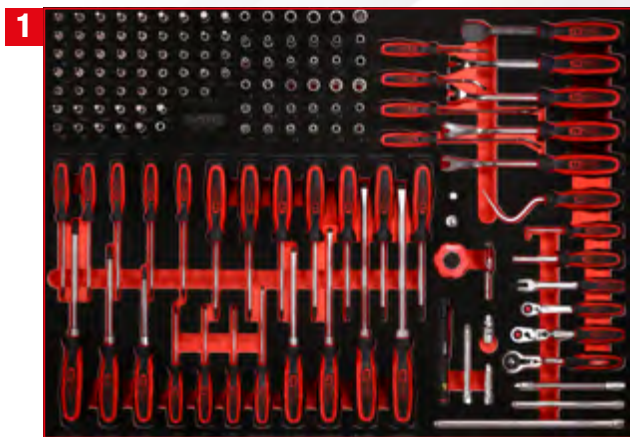

1/4" socket spanner and
screwdriver set

821.0142

For a detailed list of tools, see page 276

142

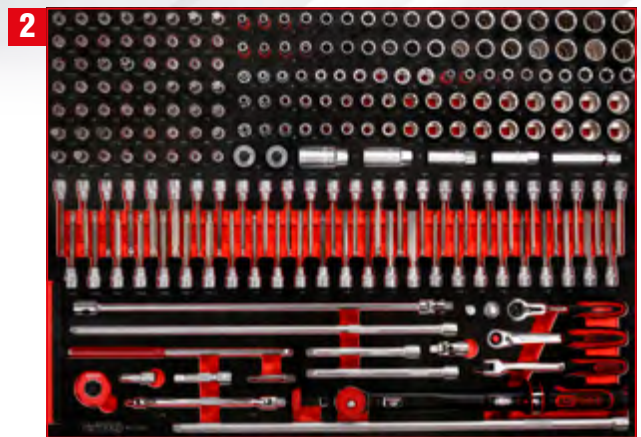

3/8" socket spanner set
in foam insert

821.0221

For a detailed list of tools, see page 278

221



1/2" socket spanner set
in foam insert

821.0149

For a detailed list of tools, see page 280

149



Screw spanner set in
foam insert

821.0076

For a detailed list of tools, see page 286

76



5

Spanner set in foam insert

821.0034

For a detailed list of tools, see page 288

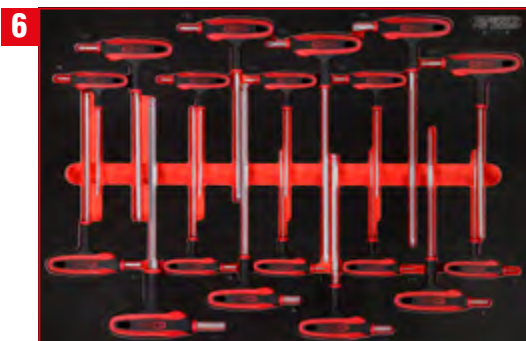

6

T-handle angle spanner set in foam insert

811.1018

For a detailed list of tools, see page 195



7

T-handle angle spanner set in foam insert

811.2018

For a detailed list of tools, see page 193



8

Measuring tool and file set in foam insert

811.0028

For a detailed list of tools, see page 234



9

Hammer and chisel set in foam insert

811.0020

For a detailed list of tools, see page 221



P 10

P 15

P 20

P 25

P 30

P 35

P 40

P 45

Single inserts

Individual parts

Accessories

P45 workshop tool trolley set with 950 tools for 13 drawers [1 | 2]

845.14950



PCS
950

XL

1 2 3 4 5

M

6 7 8 9 10 11 12 13 14

BUNDLE PRICE!

**5 x XL, 9 x M
950 pcs**

6.599,^{EUR}-

845.14950

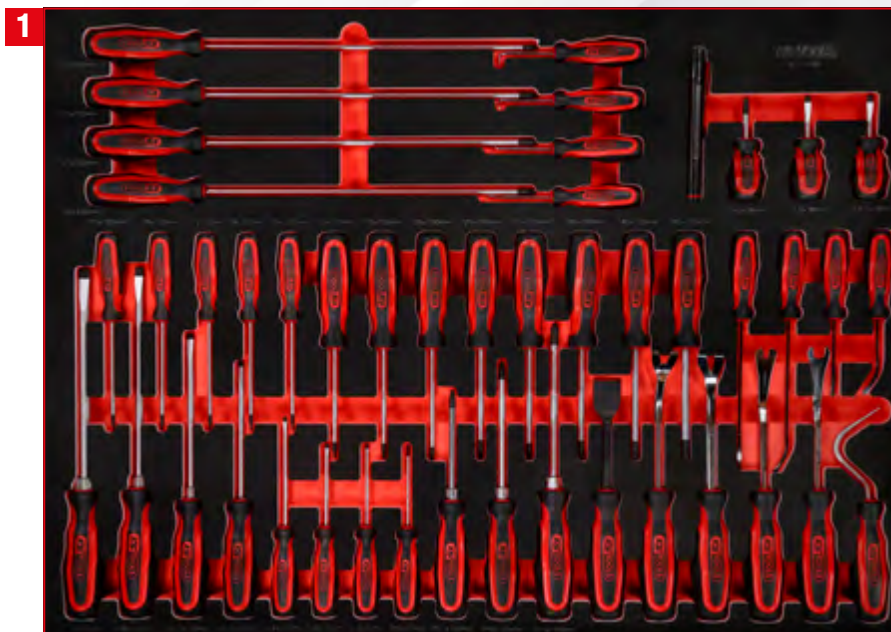

PCS
46

Screwdriver set in foam insert

821.0046

For a detailed list of tools, see page 282

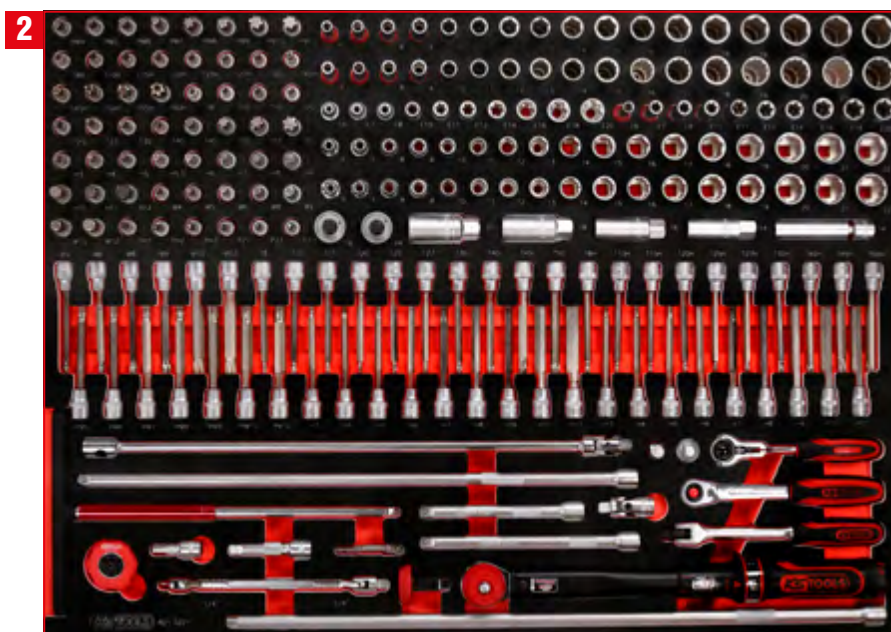

PCS
221

3/8" socket spanner set in foam insert

821.0221

For a detailed list of tools, see page 278



1 PCS
149

1/2" socket spanner set in foam insert

821.0149

For a detailed list of tools, see page 280



1 PCS
76

Screw spanner set in foam insert

821.0076

For a detailed list of tools, see page 286



1 PCS
34

Spanner set in foam insert

821.0034

For a detailed list of tools, see page 288

P 10

P 15

P 20

P 25

P 30

P 35

P 40

P 45

Single inserts

Individual parts

Accessories

P45 workshop tool trolley set with 950 tools for 13 drawers [2 | 2]

845.14950



950

XL

1 2 3 4 5

M

6 7 8 9 10 11 12 13 14

BUNDLE PRICE!

**5 x XL, 9 x M
950 pcs**

6.599,-^{EUR}

845.14950



6

1/2" impact socket set in foam insert

811.0039

For a detailed list of tools, see page 184

39



7

Screwdriver and hook set in foam insert

811.1019

For a detailed list of tools, see page 191

19



8

Hammer and chisel set in foam insert

811.0020

For a detailed list of tools, see page 221

20



9

1/4" socket spanner set in foam insert

811.0169

For a detailed list of tools, see page 136

169



10 1/2" screwdriver bit set in foam insert

811.1064

For a detailed list of tools, see page 164

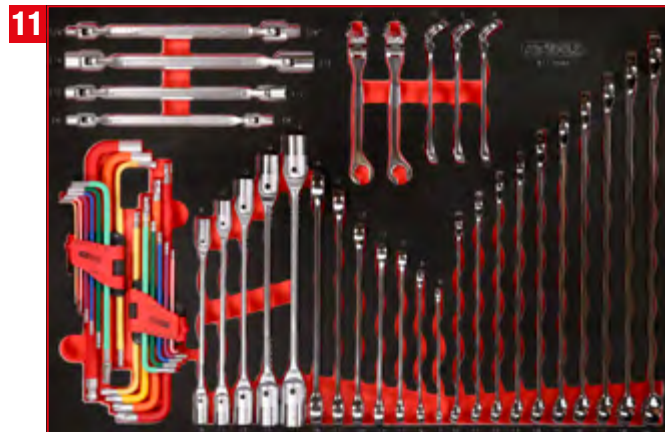

11 Screw spanner set in foam insert

811.0049

For a detailed list of tools, see page 208

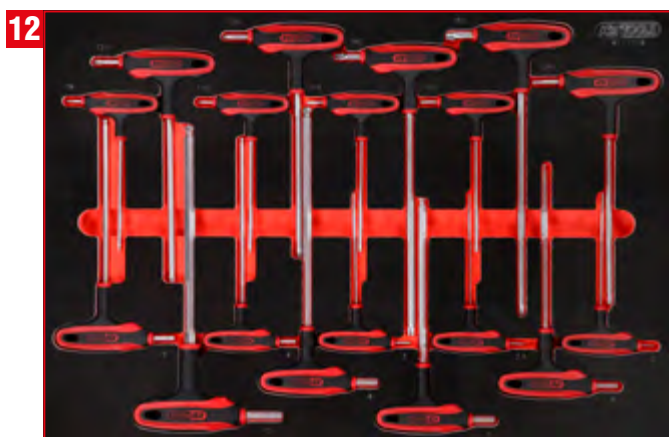

12 T-handle angle spanner set in foam insert

811.1018

For a detailed list of tools, see page 195



13 T-handle angle spanner set in foam insert

811.2018

For a detailed list of tools, see page 193



14 Measuring tool and file set in foam insert

811.0028

For a detailed list of tools, see page 234



P 10

P 15

P 20

P 25

P 30

P 35

P 40

P 45

Single inserts

Individual parts

Accessories

SUCCESSFULLY THINKING INSIDE THE BOX

S, M, L, XL: four sizes
for a better overview

OVER 100 PREASSEMBLED
TOOL INSERTS

The combination possibilities
are practically endless

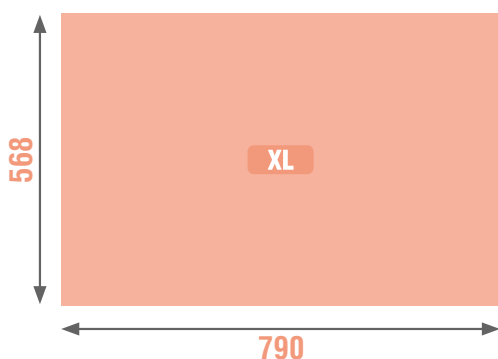
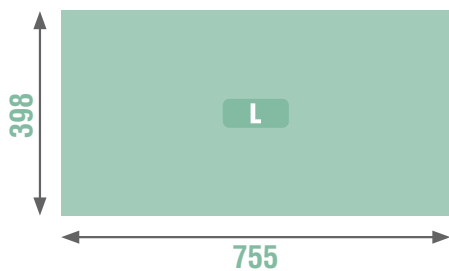
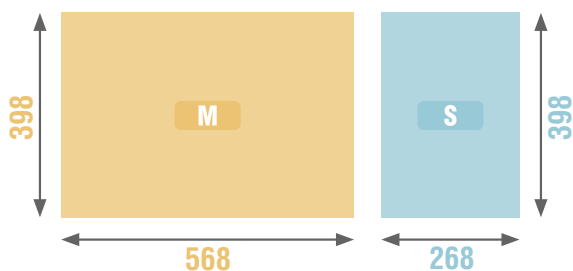

Single inserts

Overview

1/2" Screwdriver bit set	162-167
1/2" Socket spanner set	154-159, 244-251, 280
1/2" Socket spanner and screwdriver bit set	160
1/2" Impact socket spanner set	184
1/4" Socket spanner set	136
1/4" + 3/8" Socket spanner set	146-149
1/4" + 3/8" Socket wrench set	138-145, 238-240
1/4" + 3/8" + 1/2" Socket spanner set	168-177, 252
1/4" Socket spanner and screwdriver set	134, 236, 276
3/4" Socket spanner set	178
3/4" Impact socket spanner set	185
3/8" Socket spanner set	150, 242, 278
3/8" + 1/2" Socket spanner set	152
3/8" + 1/2" Impact socket spanner set	182
Hammer, chisel and measuring tool set	271
Hammer, chisel and impact socket spanner set	272
Hammer and chisel set	221, 224, 230
Hammer, chisel and file set	222
Measuring tools and file set	234
Oil and tire service set	232
Combination wrench set	200
Screwdriver set	186-190, 192, 254-255, 282
Screwdriver and hook set	191
Screwdriver and file set	256
Screwdriver and pliers set	227
Wrench and impact socket spanner set	180
Wrench set	201-215, 218, 286, 260-269
T-handle key wrench set	193, 195
T-handle and screwdriver set	194
T-handle key wrench and pliers set	257
T-handle key wrench and file set	258
Pliers set	219, 288-291
Pliers / hammer / and chisel set	220, 223, 225, 228
Set of pliers and files	226
Pliers and measuring tool set	273-274
Set of pliers and key wrenches	196

XL



Screw spanner set page 276

L



3/8" Socket spanner set page 236

M

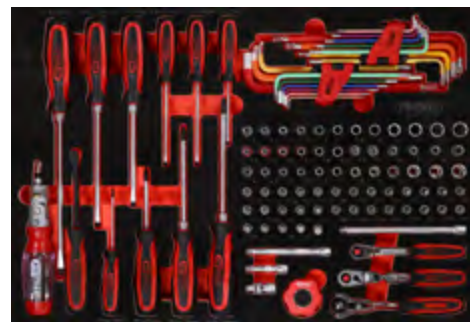

1/4" Socket spanner and screwdriver set page 134



P 10

P 15

P 20

P 25

P 30

P 35

P 40

P 45

Single inserts

Individual parts

Accessories

M 1/4" socket spanner and screwdriver set

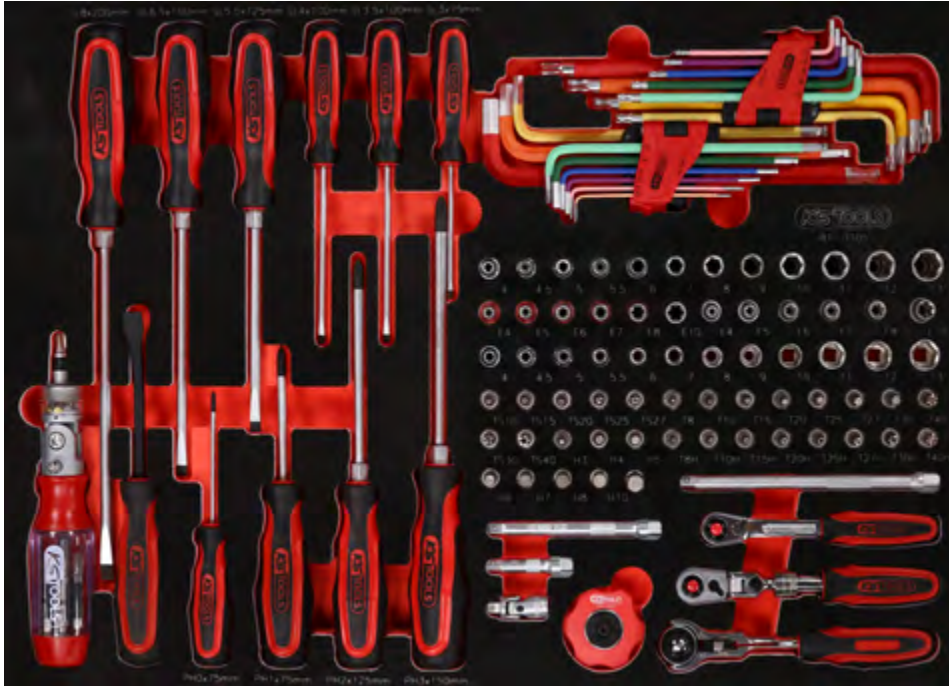

259, ^{EUR}-

105

568 x 398

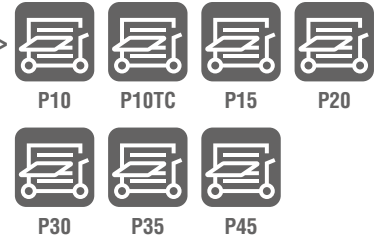

Pos.	Code	Description	pcs	Pos.	Code	Description	pcs	Pos.	Code	Description	pcs
1	159.1011	ERGOTORQUEplus screwdriver for slotted screws, 8 mm, 315 mm long	1	13	151.4420	Ball ended hexagon key wrench set, extra long, 9 pcs	9	30	917.2404	1/4" Torx E Socket, deep, E7	1
2	159.1009	ERGOTORQUEplus screwdriver for slotted screws, 6,5 mm, 255 mm long	1	14	151.4530	Ball ended Torx key wrench set, extra long and bent 108°, 9 pcs	9	31	917.2405	1/4" Torx E Socket, deep, E8	1
3	159.1006	ERGOTORQUEplus screwdriver for slotted screws, 5,5 mm, 230 mm long	1	15	917.1525	1/4" Hexagonal socket, deep, 4mm	1	32	917.2406	1/4" Torx E Socket, deep, E10	1
4	159.1004	ERGOTORQUEplus screwdriver for slotted screws, 4 mm, 180 mm long	1	16	917.1526	1/4" Hexagonal socket, deep, 4,5 mm	1	33	911.4313	1/4" Torx E Socket, E4	1
5	159.1112	ERGOTORQUEplus screwdriver for slotted screws, 3,5 mm, 180 mm long	1	17	917.1527	1/4" Hexagonal socket, deep, 5 mm	1	34	911.4314	1/4" Torx E Socket, E5	1
6	159.1002	ERGOTORQUEplus screwdriver for slotted screws, 3 mm, 155 mm long	1	18	917.1528	1/4" Hexagonal socket, deep, 5,5 mm	1	35	911.4315	1/4" Torx E Socket, E6	1
7	911.2470	1/4" Ratchet bit screwdriver, 190mm	1	19	917.1426	1/4" Hexagonal socket, deep, 6 mm	1	36	911.4316	1/4" Torx E Socket, E7	1
8	911.8101	Pry bar, 11x115mm	1	20	917.1427	1/4" Hexagonal socket, deep, 7 mm	1	37	911.4317	1/4" Torx E Socket, E8	1
9	159.1027	ERGOTORQUEplus screwdriver for screws PH, PH0, 155mm	1	21	917.1428	1/4" Hexagonal socket, deep, 8 mm	1	38	911.4332	1/4" Torx E Socket, E10	1
10	159.1020	ERGOTORQUEplus screwdriver for screws, PH1, 180 mm	1	22	917.1429	1/4" Hexagonal socket, deep, 9 mm	1	39	917.1404	1/4" Hexagonal socket, 4,5 mm	1
11	159.1022	ERGOTORQUEplus screwdriver for screws PH, PH2, 230mm	1	23	917.1430	1/4" Hexagonal socket, deep, 10 mm	1	40	917.14045	1/4" Hexagonal socket, 4,5 mm	1
12	159.1024	ERGOTORQUEplus screwdriver for screws PH, PH3, 265mm	1	24	917.1431	1/4" Hexagonal socket, deep, 11 mm	1	41	917.1405	1/4" Hexagonal socket, 5 mm	1
				25	917.1432	1/4" Hexagonal socket, deep, 12 mm	1	42	917.14055	1/4" Hexagonal socket, 5,5 mm	1
				26	917.1433	1/4" Hexagonal socket, deep, 13 mm	1	43	917.1406	1/4" Hexagonal socket, 6 mm	1
				27	917.2401	1/4" Torx E Socket, deep, E4	1	44	917.1407	1/4" Hexagonal socket, 7 mm	1
				28	917.2402	1/4" Torx E Socket, deep, E5	1	45	917.1408	1/4" Hexagonal socket, 8 mm	1
				29	917.2403	1/4" Torx E Socket, deep, E6	1	46	917.1409	1/4" Hexagonal socket, 9 mm	1
								47	917.1410	1/4" Hexagonal socket, 10 mm	1
								48	917.1411	1/4" Hexagonal socket, 11 mm	1

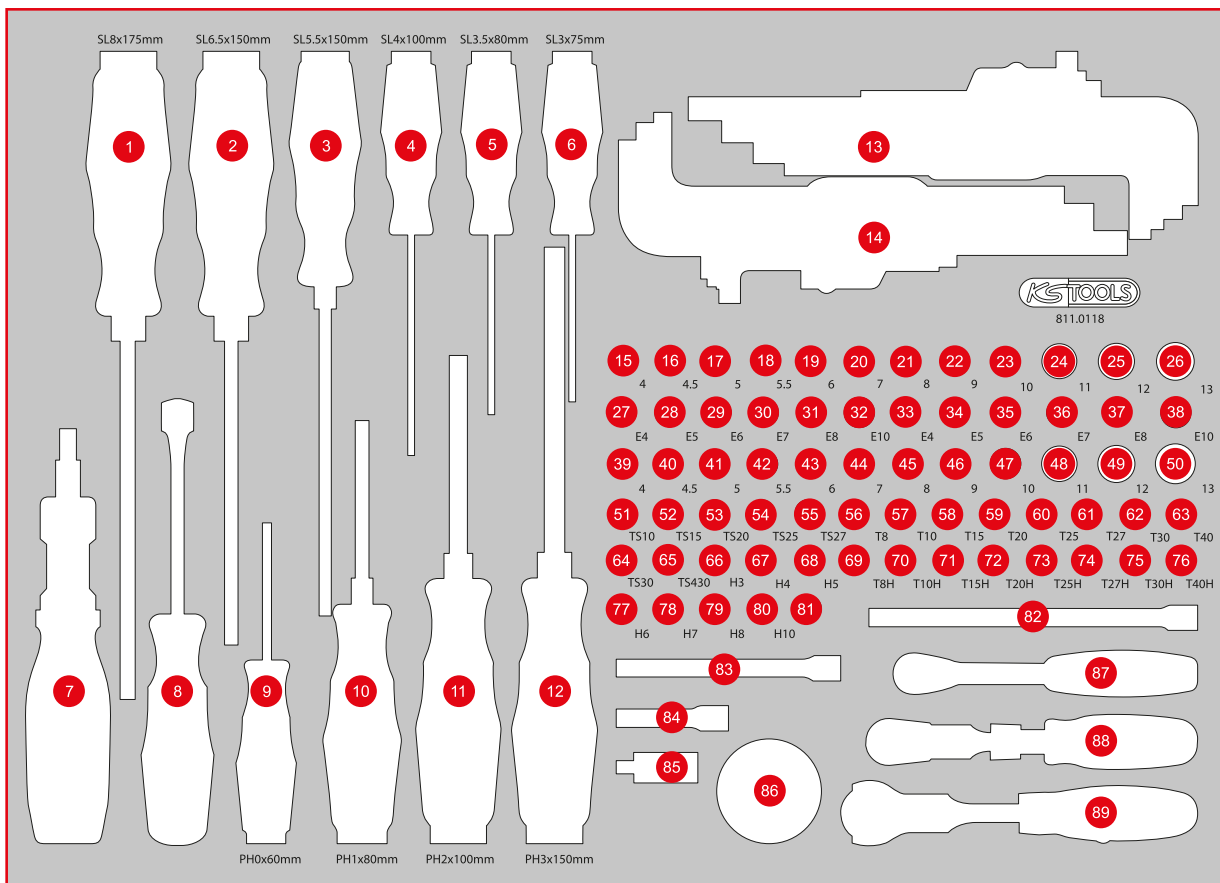

Pos.	Code	Description	pcs	Pos.	Code	Description	pcs	Pos.	Code	Description	pcs
49	917.1412	1/4" Hexagonal socket, 12 mm	1	69	911.1461	1/4" Bit socket Torx tamperproof, TB8	1	87	920.1490	1/4" SlimPOWER Reversible ratchet, 72 teeth	1
50	917.1413	1/4" Hexagonal socket, 13 mm	1	70	911.1462	1/4" Bit socket Torx tamperproof, TB10	1	88	914.1420	1/4" SlimPOWER telescopic-joint reversible ratchet, 72 teeth	1
51	911.1701	1/4" Bit socket five star tamperproof, TS10	1	71	911.1463	1/4" Bit socket Torx tamperproof, TB15	1	89	914.1405	1/4" MODIFIX mini T-handle swivel head ratchet, 72 teeth	1
52	911.1702	1/4" Bit socket five star tamperproof, TS15	1	72	911.1464	1/4" Bit socket Torx tamperproof, TB20	1				
53	911.1703	1/4" Bit socket five star tamperproof, TS20	1	73	911.1465	1/4" Bit socket Torx tamperproof, TB25	1				
54	911.1704	1/4" Bit socket five star tamperproof, TS25	1	74	911.1466	1/4" Bit socket Torx tamperproof, TB27	1				
55	911.1705	1/4" Bit socket five star tamperproof, TS27	1	75	911.1467	1/4" Bit socket Torx tamperproof, TB30	1				
56	911.1448	1/4" Bit socket Torx, T8	1	76	911.1468	1/4" Bit socket Torx tamperproof, TB40	1				
57	911.1442	1/4" Bit socket Torx, T10	1	77	911.1439	1/4" Bit socket hexagon, 6 mm	1				
58	911.1443	1/4" Bit socket Torx, T15	1	78	911.1440	1/4" Bit socket hexagon, 7 mm	1				
59	911.1444	1/4" Bit socket Torx, T20	1	79	911.1441	1/4" Bit socket hexagon, 8 mm	1				
60	911.1445	1/4" Bit socket Torx, T25	1	80	917.1452	1/4" Bit socket hexagon, 10 mm	1				
61	911.1449	1/4" Bit socket Torx, T27	1	81	911.0101	1/4" socket with magnet	1				
62	911.1446	1/4" Bit socket Torx, T30	1	82	911.1451	1/4" Extension with hexagon drive, 150mm	1				
63	911.1447	1/4" Bit socket Torx, T40	1	83	911.1424	1/4" Extension with hexagon drive, 100 mm	1				
64	911.1706	1/4" Bit socket five star tamperproof, TS30	1	84	911.1423	1/4" Extension with hexagon drive, 50 mm	1				
65	911.1707	1/4" Bit socket five star tamperproof, TS40	1	85	911.1450	1/4" Universal joint	1				
66	911.1436	1/4" Bit socket hexagon, 3mm	1	86	914.1410	Mini hand reversible ratchet, 1/4", 72 teeth	1				
67	911.1437	1/4" Bit socket hexagon, 4 mm	1								
68	911.1438	1/4" Bit socket hexagon, 5 mm	1								

P 10
P 15
P 20
P 25
P 30
P 35
P 40
P 45
S XL L M
Individual parts
Accessories

811.0169

M 1/4" socket spanner set



449, — ^{EUR}

169

568 x 398

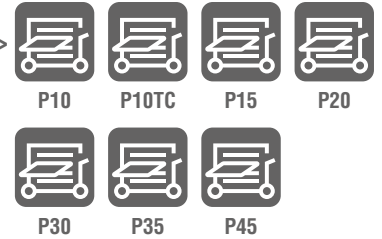

Pos.	Code	Description	pcs	Pos.	Code	Description	pcs	Pos.	Code	Description	pcs
1	917.2414	Flex Socket TX E, 1/4", E5	1	30	917.2428	bi hex socket, uni joint, 1/4" 13 mm	1	59	911.1705	1/4" Bit socket five star tamperproof, TS27	1
2	917.2415	Flex Socket TX E, 1/4", E6	1	31	917.1604	1/4" 12 Point socket, deep, 4 mm	1	60	911.1706	1/4" Bit socket five star tamperproof, TS30	1
3	917.2416	Flex Socket TX E, 1/4", E7	1	32	917.16045	1/4" 12 Point socket, deep, 4,5 mm	1	61	911.1707	1/4" Bit socket five star tamperproof, TS40	1
4	917.2417	Flex Socket TX E, 1/4", E8	1	33	917.1605	1/4" 12 Point socket, deep, 5 mm	1	62	911.1708	1/4" Bit socket five star tamperproof, TS45	1
5	917.2401	1/4" Torx E Socket, deep, E4	1	34	917.16055	1/4" 12 Point socket, deep, 5,5 mm	1	63	911.1709	1/4" Bit socket five star tamperproof, TS50	1
6	917.2402	1/4" Torx E Socket, deep, E5	1	35	917.1606	1/4" 12 Point socket, deep, 6 mm	1	64	911.3772	1/4" Bit socket Torx, ball ended, T15	1
7	917.2403	1/4" Torx E Socket, deep E6	1	36	917.1607	1/4" 12 Point socket, deep, 7 mm	1	65	911.3773	1/4" Bit socket Torx, ball ended, T20	1
8	917.2404	1/4" Torx E Socket, deep E7	1	37	917.1608	1/4" 12 Point socket, deep, 8 mm	1	66	911.3774	1/4" Bit socket Torx, ball ended, T25	1
9	917.2405	1/4" Torx E Socket, deep E8	1	38	917.1609	1/4" 12 Point socket, deep, 9 mm	1	67	911.3775	1/4" Bit socket Torx, ball ended, T27	1
10	917.2406	1/4" Torx E Socket, deep E10	1	39	917.1610	1/4" 12 Point socket, deep, 10 mm	1	68	911.3776	1/4" Bit socket Torx, ball ended, T30	1
11	917.1525	1/4" Hexagonal socket, deep, 4 mm	1	40	917.1611	1/4" 12 Point socket, deep, 11 mm	1	69	911.3777	1/4" Bit socket Torx, ball ended, T40	1
12	917.1526	1/4" Hexagonal socket, deep, 4,5 mm	1	41	917.1612	1/4" 12 Point socket, deep, 12 mm	1	70	917.1456	TX bit socket tamperproof, 1/4", TB6	1
13	917.1527	1/4" Hexagonal socket, deep, 5 mm	1	42	917.1613	1/4" 12 Point socket, deep, 13 mm	1	71	917.1457	TX bit socket tamperproof, 1/4", TB7	1
14	917.1528	1/4" Hexagonal socket, deep, 5,5 mm	1	43	911.4407	1/4" Bit socket Torx, T6	1	72	911.1461	TX bit socket tamperproof, 1/4", TB8	1
15	917.1426	1/4" Hexagonal socket, deep, 6 mm	1	44	911.4362	1/4" Bit socket Torx, T7	1	73	911.1485	TX bit socket tamperproof, 1/4", TB9	1
16	917.1427	1/4" Hexagonal socket, deep, 7 mm	1	45	911.1448	1/4" Bit socket Torx, T8	1	74	911.1462	TX bit socket tamperproof, 1/4", TB10	1
17	917.1428	1/4" Hexagonal socket, deep, 8 mm	1	46	911.1478	1/4" Bit socket Torx, T9	1	75	911.1463	TX bit socket tamperproof, 1/4", TB15	1
18	917.1429	1/4" Hexagonal socket, deep, 9 mm	1	47	911.1442	1/4" Bit socket Torx, T10	1	76	911.1464	TX bit socket tamperproof, 1/4", TB20	1
19	917.1430	1/4" Hexagonal socket, deep, 10 mm	1	48	911.1443	1/4" Bit socket Torx, T15	1	77	911.1465	TX bit socket tamperproof, 1/4", TB25	1
20	917.1431	1/4" Hexagonal socket, deep, 11 mm	1	49	911.1444	1/4" Bit socket Torx, T20	1	78	911.1466	TX bit socket tamperproof, 1/4", TB27	1
21	917.1432	1/4" Hexagonal socket, deep, 12 mm	1	50	911.1445	1/4" Bit socket Torx, T25	1	79	911.1467	TX bit socket tamperproof, 1/4", TB30	1
22	917.1433	1/4" Hexagonal socket, deep, 13 mm	1	51	911.1449	1/4" Bit socket Torx, T27	1	80	911.1468	TX bit socket tamperproof, 1/4", TB40	1
23	917.2421	bi hex socket, uni joint, 1/4", 6 mm	1	52	911.1446	1/4" Bit socket Torx, T30	1	81	911.1482	1/4" Bit socket, PH0	1
24	917.2422	bi hex socket, uni joint, 1/4" 7 mm	1	53	911.1447	1/4" Bit socket Torx, T40	1	82	911.1415	1/4" Bit socket, PH1	1
25	917.2423	bi hex socket, uni joint, 1/4" 8 mm	1	54	917.1578	1/4" Torx Plus Bit-Socket 8IPR	1	83	911.1416	1/4" Bit socket, PH2	1
26	917.2424	bi hex socket, uni joint, 1/4" 9 mm	1	55	911.1701	1/4" Bit socket five star tamperproof, TS10	1	84	911.1417	1/4" Bit socket, PH3	1
27	917.2425	bi hex socket, uni joint, 1/4" 10 mm	1	56	911.1702	1/4" Bit socket five star tamperproof, TS15	1	85	911.1436	1/4" Bit socket hexagon, 3mm	1
28	917.2426	bi hex socket, uni joint, 1/4" 11 mm	1	57	911.1703	1/4" Bit socket five star tamperproof, TS20	1	86	911.1437	1/4" Bit socket hexagon, 4 mm	1
29	917.2427	bi hex socket, uni joint, 1/4" 12 mm	1	58	911.1704	1/4" Bit socket five star tamperproof, TS25	1	87	911.1438	1/4" Bit socket hexagon, 5 mm	1

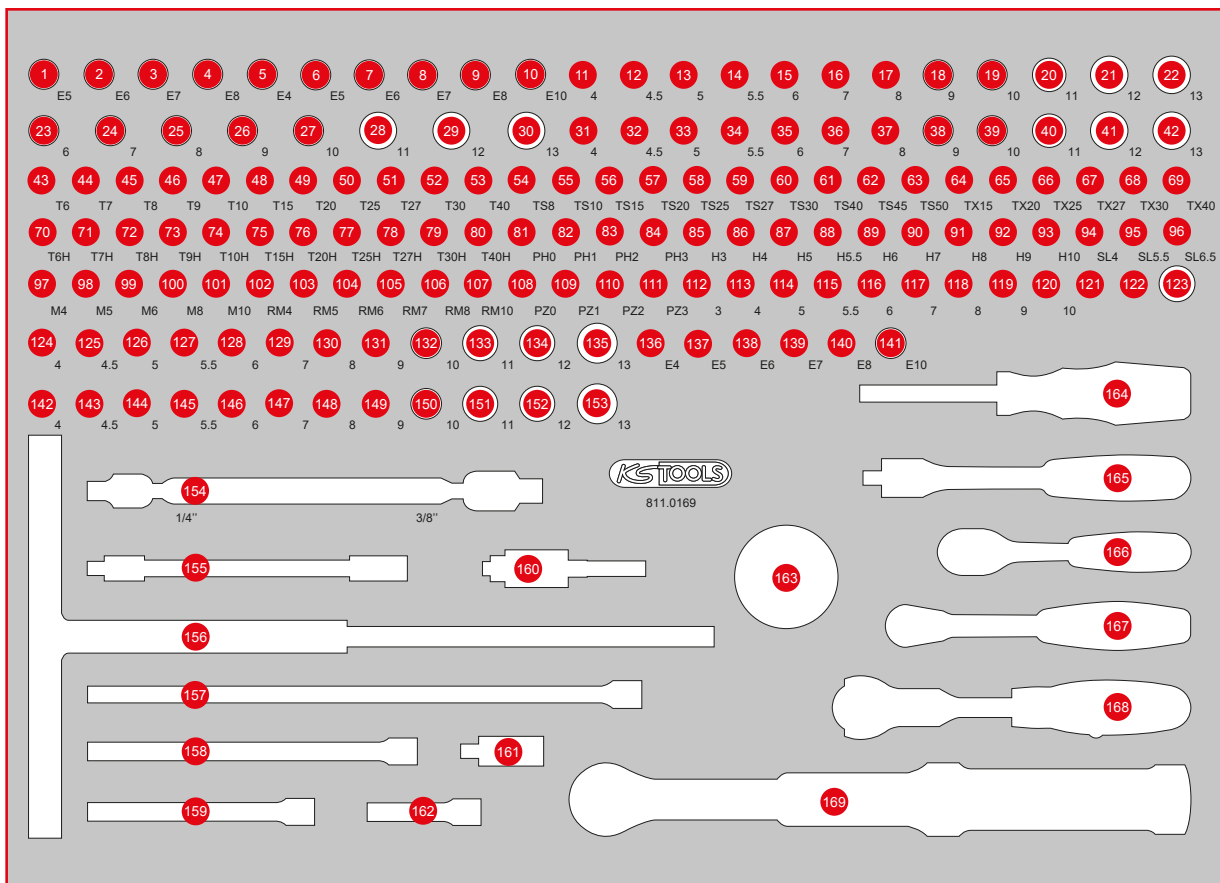

Pos.	Code	Description	pcs	Pos.	Code	Description	pcs	Pos.	Code	Description	pcs
88	911.14385	1/4" Bit socket hexagon, 5,5 mm	1	117	917.2447	1/4" Hex bit socket, ball ended, 1/4", 7mm	1	146	917.1465	1/4" 12 Point socket, 6mm	1
89	911.1439	1/4" Bit socket hexagon, 6 mm	1	118	917.2448	1/4" Hex bit socket, ball ended, 1/4", 8mm	1	147	917.1466	1/4" 12 Point socket, 7mm	1
90	911.1440	1/4" Bit socket hexagon, 7 mm	1	119	917.2449	1/4" Hex bit socket, ball ended, 1/4", 9mm	1	148	917.1467	1/4" 12 Point socket, 8mm	1
91	911.1441	1/4" Bit socket hexagon, 8 mm	1	120	917.2450	1/4" Hex bit socket, ball ended, 1/4", 10mm	1	149	917.1468	1/4" 12 Point socket, 9mm	1
92	917.1454	1/4" Bit socket hexagon, 9 mm	1	121	911.0101	1/4" socket with magnet	1	150	917.1469	1/4" 12 Point socket, 10mm	1
93	917.1452	1/4" Bit socket hexagon, 10mm	1	122	911.1494	Adaptor, 1/4" Mx 3/8" F	1	151	917.1470	1/4" 12 Point socket, 11mm	1
94	911.1418	1/4" Bit socket slot, 4mm	1	123	911.3897	Reducing adaptor, 3/8" Fx 1/4" M	1	152	917.1471	1/4" 12 Point socket, 12mm	1
95	911.1419	1/4" Bit socket slot, 5,5 mm	1	124	917.1404	1/4" Hexagonal socket, 4mm	1	153	917.1472	1/4" 12 Point socket, 13mm	1
96	917.1421	1/4" Bit socket slot, 6,5 mm	1	125	917.14045	1/4" Hexagonal socket, 4,5mm	1	154	517.0338	Double-joint-spanner for 1/4" and 3/8" sockets	1
97	917.1541	1/4" Bit socket spline (XZN), M4	1	126	917.1405	1/4" Hexagonal socket, 5mm	1	155	911.1422	Extension, flexible, 1/4", 150mm	1
98	917.1542	1/4" Bit socket spline (XZN), M5	1	127	917.14055	1/4" Hexagonal socket, 5,5mm	1	156	911.2369	1/4" T-Handle-Spinner	1
99	917.1543	1/4" Bit socket spline (XZN), M6	1	128	917.1406	1/4" Hexagonal socket, 6mm	1	157	911.1504	1/4" Extension with hexagon drive, 250mm	1
100	917.1545	1/4" Bit socket spline (XZN), M8	1	129	917.1407	1/4" Hexagonal socket, 7mm	1	158	911.1451	1/4" Extension with hexagon drive, 150mm	1
101	917.1546	1/4" Bit socket spline (XZN), M10	1	130	917.1408	1/4" Hexagonal socket, 8mm	1	159	911.1424	1/4" Extension with hexagon drive, 100mm	1
102	917.1584	1/4" RIBE Socket M4	1	131	917.1409	1/4" Hexagonal socket, 9mm	1	160	514.1126	1/4" 2in1 quick-replacement bit holder	1
103	917.1585	1/4" RIBE Socket M5S	1	132	917.1410	1/4" Hexagonal socket, 10mm	1	161	911.1450	1/4" Universal joint	1
104	917.1586	1/4" RIBE Socket M6S	1	133	917.1411	1/4" Hexagonal socket, 11mm	1	162	911.1423	1/4" Extension with hexagon drive, 50mm	1
105	917.1587	1/4" RIBE Socket M7S	1	134	917.1412	1/4" Hexagonal socket, 12mm	1	163	914.1410	Mini hand reversible ratchet, 1/4", 72 teeth	1
106	917.1588	1/4" RIBE Socket M8S	1	135	917.1413	1/4" Hexagonal socket, 13mm	1	164	911.1434	1/4" Square drive screwdriver, 150mm	1
107	917.1590	1/4" RIBE Socket M10S	1	136	911.4313	1/4" Torx E Socket, E4	1	165	917.1488	1/4" Flexible handle	1
108	911.1483	1/4" Bit socket, PZ0	1	137	911.4314	1/4" Torx E Socket, E5	1	166	911.1510	Mini-reversible ratchet, 1/4", 72 teeth	1
109	911.1401	1/4" Bit socket, PZ1	1	138	911.4315	1/4" Torx E Socket, E6	1	167	920.1490	1/4" SlimPOWER Reversible ratchet, 72 teeth	1
110	911.1402	1/4" Bit socket, PZ2	1	139	911.4316	1/4" Torx E Socket, E7	1	168	914.1405	1/4" MODIFIX mini T-handle swivel head ratchet, 72 teeth	1
111	911.1403	1/4" Bit socket, PZ3	1	140	911.4317	1/4" Torx E Socket, E8	1	169	516.1412	1/4" ERGOTORQUE™ precision torque wrench with rotary mushroom ratchet head, 5-25Nm	1
112	917.2443	1/4" Hex bit socket, ball ended, 1/4", 3mm	1	141	911.4332	1/4" Torx E Socket, E10	1				
113	917.2444	1/4" Hex bit socket, ball ended, 1/4", 4mm	1	142	917.1461	1/4" 12 Point socket, 4mm	1				
114	917.2445	1/4" Hex bit socket, ball ended, 1/4", 5mm	1	143	917.1462	1/4" 12 Point socket, 4,5mm	1				
115	917.24455	1/4" Hex bit socket, ball ended, 1/4", 5,5mm	1	144	917.1463	1/4" 12 Point socket, 5mm	1				
116	917.2446	1/4" Hex bit socket, ball ended, 1/4", 6mm	1	145	917.1464	1/4" 12 Point socket, 5,5mm	1				

P 10
P 15
P 20
P 25
P 30
P 35
P 40
P 45
Individual parts S XL L M
Accessories

811.0140

M 1/4" + 3/8" socket spanner set



359, — ^{EUR}

1PCS
140

568 x 398

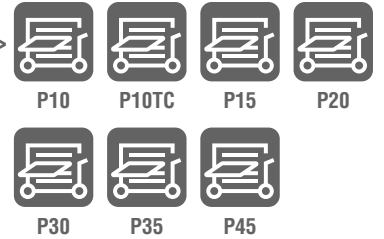

Pos.	Code	Description	pcs	Pos.	Code	Description	pcs	Pos.	Code	Description	pcs
1	911.3863	3/8" Bit socket hexagon, 3 mm	1	24	911.4339	3/8" Torx E Socket, E5	1	47	917.3809	3/8" Hexagonal socket, 9 mm	1
2	911.3864	3/8" Bit socket hexagon, 4 mm	1	25	911.4340	3/8" Torx E Socket, E6	1	48	917.3810	3/8" Hexagonal socket, 10 mm	1
3	911.3865	3/8" Bit socket hexagon, 5 mm	1	26	911.4341	3/8" Torx E Socket, E7	1	49	917.3811	3/8" Hexagonal socket, 11 mm	1
4	911.38655	3/8" Bit socket hexagon, 5,5 mm	1	27	911.4342	3/8" Torx E Socket, E8	1	50	917.3812	3/8" Hexagonal socket, 12 mm	1
5	911.3866	3/8" Bit socket hexagon, 6 mm	1	28	911.4318	3/8" Torx E Socket, E10	1	51	917.3813	3/8" Hexagonal socket, 13 mm	1
6	911.3867	3/8" Bit socket hexagon, 7 mm	1	29	911.4319	3/8" Torx E Socket, E11	1	52	917.3814	3/8" Hexagonal socket, 14 mm	1
7	911.3868	3/8" Bit socket hexagon, 8 mm	1	30	911.4320	3/8" Torx E Socket, E12	1	53	917.3815	3/8" Hexagonal socket, 15 mm	1
8	917.3969	3/8" Bit socket hexagon, 9 mm	1	31	911.4321	3/8" Torx E Socket, E14	1	54	917.3816	3/8" Hexagonal socket, 16 mm	1
9	917.3857	3/8" Bit socket hexagon, 10 mm	1	32	911.3961	3/8" Bit socket Torx tamperproof, TB15	1	55	917.3817	3/8" Hexagonal socket, 17 mm	1
10	911.3869	3/8" Bit socket Torx, T15	1	33	911.3962	3/8" Bit socket Torx tamperproof, TB20	1	56	917.3818	3/8" Hexagonal socket, 18 mm	1
11	911.3870	3/8" Bit socket Torx, T20	1	34	911.3963	3/8" Bit socket Torx tamperproof, TB25	1	57	917.3819	3/8" Hexagonal socket, 19 mm	1
12	911.3871	3/8" Bit socket Torx, T25	1	35	911.3964	3/8" Bit socket Torx tamperproof, TB27	1	58	917.3820	3/8" Hexagonal socket, 20 mm	1
13	911.3872	3/8" Bit socket Torx, T27	1	36	911.3965	3/8" Bit socket Torx tamperproof, TB30	1	59	917.3821	3/8" Hexagonal socket, 21 mm	1
14	911.3873	3/8" Bit socket Torx, T30	1	37	911.3966	3/8" Bit socket Torx tamperproof, TB40	1	60	917.3822	3/8" Hexagonal socket, 22 mm	1
15	911.3874	3/8" Bit socket Torx, T40	1	38	911.3967	3/8" Bit socket Torx tamperproof, TB45	1	61	911.1436	1/4" Bit socket hexagon, 3 mm	1
16	911.3885	3/8" Bit socket Torx, T45	1	39	911.3968	3/8" Bit socket Torx tamperproof, TB50	1	62	911.1437	1/4" Bit socket hexagon, 4 mm	1
17	911.3884	3/8" Bit socket Torx, T50	1	40	911.3969	3/8" Bit socket Torx tamperproof, TB55	1	63	911.1438	1/4" Bit socket hexagon, 5 mm	1
18	911.3888	3/8" Bit socket Torx, T55	1	41	917.3901	3/8" Bit socket spline (XZN), M9	1	64	911.1439	1/4" Bit socket hexagon, 6 mm	1
19	911.3918	3/8" Bit socket spline (XZN), M4	1	42	911.3920	3/8" Bit socket spline (XZN), M10	1	65	911.1440	1/4" Bit socket hexagon, 7 mm	1
20	911.3915	3/8" Bit socket spline (XZN), M5	1	43	917.3903	3/8" Bit socket spline (XZN), M12	1	66	911.1441	1/4" Bit socket hexagon, 8 mm	1
21	911.3916	3/8" Bit socket spline (XZN), M6	1	44	917.3806	3/8" Hexagonal socket, 6 mm	1	67	917.1541	1/4" Bit socket spline (XZN), M4	1
22	911.3917	3/8" Bit socket spline (XZN), M8	1	45	917.3807	3/8" Hexagonal socket, 7 mm	1	68	917.1542	1/4" Bit socket spline (XZN), M5	1
23	911.4338	3/8" Torx E Socket, E4	1	46	917.3808	3/8" Hexagonal socket, 8 mm	1	69	917.1543	1/4" Bit socket spline (XZN), M6	1

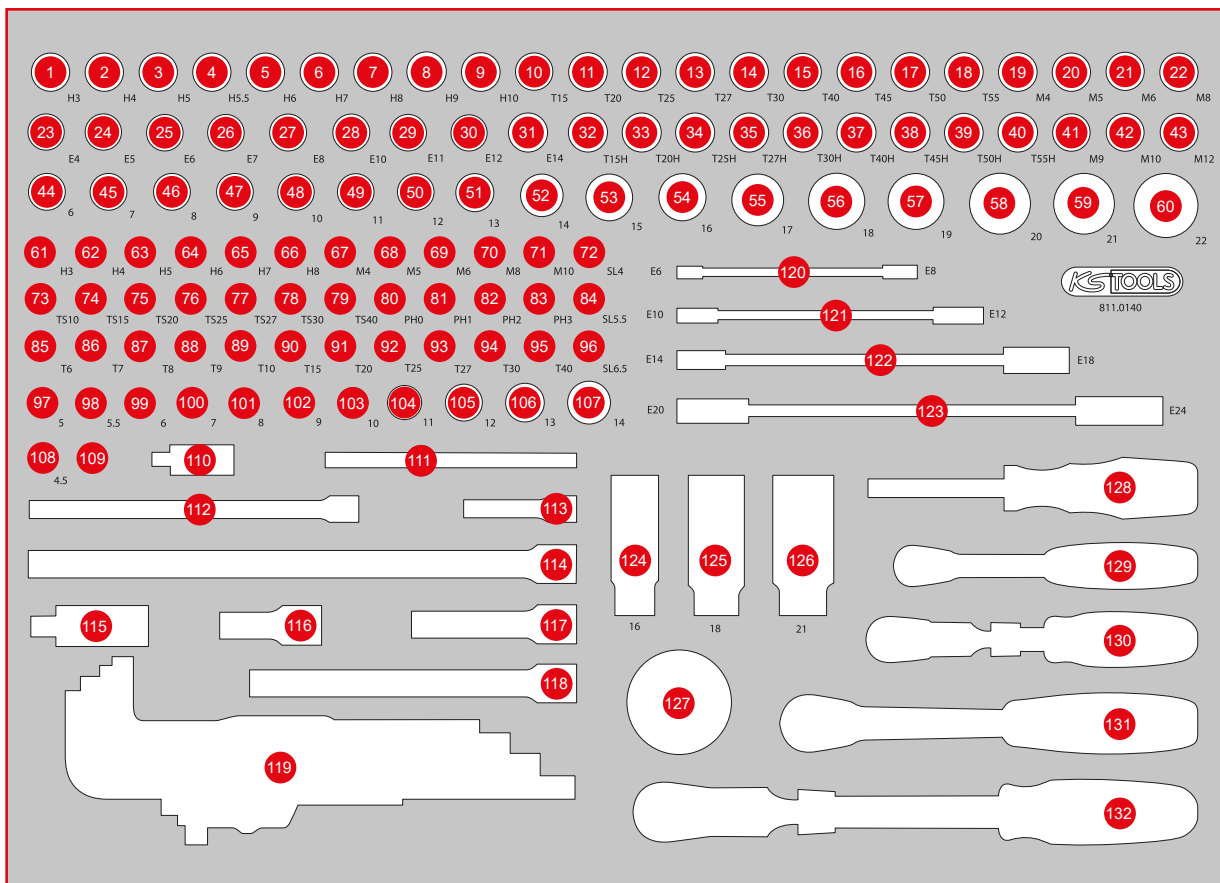

Pos.	Code	Description	pcs	Pos.	Code	Description	pcs	Pos.	Code	Description	pcs
70	917.1545	1/4" Bit socket spline (XZN), M8	1	93	911.1449	1/4" Bit socket Torx, T27	1	116	911.3852	3/8" Extension with knurling, 45 mm	1
71	917.1546	1/4" Bit socket spline (XZN), M10	1	94	911.1446	1/4" Bit socket Torx, T30	1	117	911.3801	3/8" Extension with knurling, 75 mm	1
72	911.1418	1/4" Bit socket slot, 4 mm	1	95	911.1447	1/4" Bit socket Torx, T40	1	118	911.3802	3/8" Extension with knurling, 150 mm	1
73	911.1701	1/4" Bit socket five star tamperproof, TS10	1	96	917.1421	1/4" Bit socket slot, 6,5 mm	1	119	151.5210	Ball head Torx angled socket wrench set, extra long, 9 pcs	9
74	911.1702	1/4" Bit socket five star tamperproof, TS15	1	97	917.1405	1/4" Hexagonal socket, 5 mm	1	120	911.0371	Double ring spanner for Torx E profile, E6 x E8	1
75	911.1703	1/4" Bit socket five star tamperproof, TS20	1	98	917.14055	1/4" Hexagonal socket, 5,5 mm	1	121	911.0373	Double ring spanner for Torx E profile, E10 x E12	1
76	911.1704	1/4" Bit socket five star tamperproof, TS25	1	99	917.1406	1/4" Hexagonal socket, 6 mm	1	122	911.0374	Double ring spanner for Torx E profile, E14 x E18	1
77	911.1705	1/4" Bit socket five star tamperproof, TS27	1	100	917.1407	1/4" Hexagonal socket, 7 mm	1	123	911.0376	Double ring spanner for Torx E profile, E20 x E24	1
78	911.1706	1/4" Bit socket five star tamperproof, TS30	1	101	917.1408	1/4" Hexagonal socket, 8 mm	1	124	911.3804	3/8" Spark plug socket, 16 mm	1
79	911.1707	1/4" Bit socket five star tamperproof, TS40	1	102	917.1409	1/4" Hexagonal socket, 9 mm	1	125	911.3823	3/8" Spark plug socket, 18 mm	1
80	911.1482	1/4" Bit socket, PH0	1	103	917.1410	1/4" Hexagonal socket, 10 mm	1	126	911.3805	3/8" Spark plug socket, 21 mm	1
81	911.1415	1/4" Bit socket, PH1	1	104	917.1411	1/4" Hexagonal socket, 11 mm	1	127	914.1410	Mini hand reversible ratchet, 1/4", 72 teethh	1
82	911.1416	1/4" Bit socket, PH2	1	105	917.1412	1/4" Hexagonal socket, 12 mm	1	128	911.1434	1/4" Square drive screwdriver, 150 mm	1
83	911.1417	1/4" Bit socket, PH3	1	106	917.1413	1/4" Hexagonal socket, 13 mm	1	129	920.1490	1/4" SlimPOWER Reversible ratchet, 72 teeth	1
84	911.1419	1/4" Bit socket slot, 5,5 mm	1	107	917.1414	1/4" Hexagonal socket, 14 mm	1	130	914.1420	1/4" SlimPOWER telescopic-joint reversible ratchet, 72 teeth	1
85	911.4407	1/4" Bit socket Torx, T6	1	108	917.14045	1/4" Hexagonal socket, 4,5 mm	1	131	920.3890	3/8" SlimPOWER Reversible ratchet, 72 teeth	1
86	911.4362	1/4" Bit socket Torx, T7	1	109	911.0101	1/4" socket with magnet	1	132	914.3820	3/8" SlimPOWER Telescopic reversible ratchet, 72 teeth	1
87	911.1448	1/4" Bit socket Torx, T8	1	110	911.1450	1/4" Universal joint	1				
88	911.1478	1/4" Bit socket Torx, T9	1	111	911.1425	Sliding T-bar, 1/4", 110 mm	1				
89	911.1442	1/4" Bit socket Torx, T10	1	112	911.1451	1/4" Extension with hexagon drive, 150 mm	1				
90	911.1443	1/4" Bit socket Torx, T15	1	113	911.1423	1/4" Extension with hexagon drive, 50 mm	1				
91	911.1444	1/4" Bit socket Torx, T20	1	114	911.3803	3/8" Extension with knurling, 250 mm	1				
92	911.1445	1/4" Bit socket Torx, T25	1	115	911.3850	3/8" Universal joint	1				

P 10
P 15
P 20
P 25
P 30
P 35
P 40
P 45
S
XL
L
M
Individual parts
Accessories

811.1142

M 1/4" + 3/8" socket spanner set



329, — ^{EUR}

1PCS
142

568 x 398

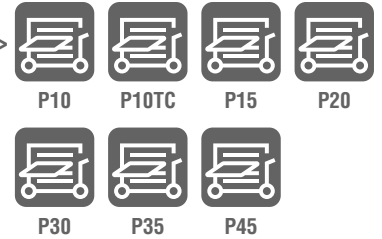

Pos.	Code	Description	pcs	Pos.	Code	Description	pcs	Pos.	Code	Description	pcs
1	917.4807	3/8" Hexagonal socket, deep, 7 mm	1	25	911.3865	3/8" Bit socket hexagon, 5 mm	1	49	917.3808	3/8" Hexagonal socket, 8 mm	1
2	917.3828	3/8" Hexagonal socket, deep, 8 mm	1	26	911.38655	3/8" Bit socket hexagon, 5,5 mm	1	50	917.3809	3/8" Hexagonal socket, 9 mm	1
3	917.3829	3/8" Hexagonal socket, deep, 9 mm	1	27	911.3866	3/8" Bit socket hexagon, 6 mm	1	51	917.3810	3/8" Hexagonal socket, 10 mm	1
4	917.3830	3/8" Hexagonal socket, deep, 10 mm	1	28	911.3867	3/8" Bit socket hexagon, 7 mm	1	52	917.3811	3/8" Hexagonal socket, 11 mm	1
5	917.3831	3/8" Hexagonal socket, deep, 11 mm	1	29	911.3868	3/8" Bit socket hexagon, 8 mm	1	53	917.3812	3/8" Hexagonal socket, 12 mm	1
6	917.3832	3/8" Hexagonal socket, deep, 12 mm	1	30	917.3969	3/8" Bit socket hexagon, 9 mm	1	54	917.3813	3/8" Hexagonal socket, 13 mm	1
7	917.3833	3/8" Hexagonal socket, deep, 13 mm	1	31	917.3857	3/8" Bit socket hexagon, 10 mm	1	55	917.3814	3/8" Hexagonal socket, 14 mm	1
8	917.3834	3/8" Hexagonal socket, deep, 14 mm	1	32	911.3918	3/8" Bit socket spline (XZN), M4	1	56	917.3815	3/8" Hexagonal socket, 15 mm	1
9	917.3835	3/8" Hexagonal socket, deep, 15 mm	1	33	911.3915	3/8" Bit socket spline (XZN), M5	1	57	917.3816	3/8" Hexagonal socket, 16 mm	1
10	917.3836	3/8" Hexagonal socket, deep, 16 mm	1	34	911.3916	3/8" Bit socket spline (XZN), M6	1	58	917.3817	3/8" Hexagonal socket, 17 mm	1
11	917.3837	3/8" Hexagonal socket, deep, 17 mm	1	35	911.3917	3/8" Bit socket spline (XZN), M8	1	59	917.3818	3/8" Hexagonal socket, 18 mm	1
12	917.3838	3/8" Hexagonal socket, deep, 18 mm	1	36	917.3901	3/8" Bit socket spline (XZN), M9	1	60	917.3819	3/8" Hexagonal socket, 19 mm	1
13	917.3839	3/8" Hexagonal socket, deep, 19 mm	1	37	911.3920	3/8" Bit socket spline (XZN), M10	1	61	917.3820	3/8" Hexagonal socket, 20 mm	1
14	917.3840	3/8" Hexagonal socket, deep, 20 mm	1	38	917.3903	3/8" Bit socket spline (XZN), M12	1	62	917.3821	3/8" Hexagonal socket, 21 mm	1
15	917.3841	3/8" Hexagonal socket, deep, 21 mm	1	39	911.3869	3/8" Bit socket Torx, T15	1	63	917.3822	3/8" Hexagonal socket, 22 mm	1
16	917.4851	3/8" 12-edge socket with joint, 10 mm	1	40	911.3870	3/8" Bit socket Torx, T20	1	64	911.4339	3/8" Torx E Socket, E5	1
17	917.4852	3/8" 12-edge socket with joint, 11 mm	1	41	911.3871	3/8" Bit socket Torx, T25	1	65	911.4340	3/8" Torx E Socket, E6	1
18	917.4853	3/8" 12-edge socket with joint, 12 mm	1	42	911.3872	3/8" Bit socket Torx, T27	1	66	911.4341	3/8" Torx E Socket, E7	1
19	917.4854	3/8" 12-edge socket with joint, 13 mm	1	43	911.3873	3/8" Bit socket Torx, T30	1	67	911.4342	3/8" Torx E Socket, E8	1
20	917.4855	3/8" 12-edge socket with joint, 14 mm	1	44	911.3874	3/8" Bit socket Torx, T40	1	68	911.4318	3/8" Torx E Socket, E10	1
21	917.4856	3/8" 12-edge socket with joint, 15 mm	1	45	911.3885	3/8" Bit socket Torx, T45	1	69	911.4319	3/8" Torx E Socket, E11	1
22	917.4857	3/8" 12-edge socket with joint, 16 mm	1	46	911.3884	3/8" Bit socket Torx, T50	1	70	911.4320	3/8" Torx E Socket, E12	1
23	911.3863	3/8" Bit socket hexagon, 3 mm	1	47	911.3888	3/8" Bit socket Torx, T55	1	71	911.4321	3/8" Torx E Socket, E14	1
24	911.3864	3/8" Bit socket hexagon, 4 mm	1	48	917.3807	3/8" Hexagonal socket, 7 mm	1	72	917.1448	1/4" Hexagonal socket, deep, 14 mm	1

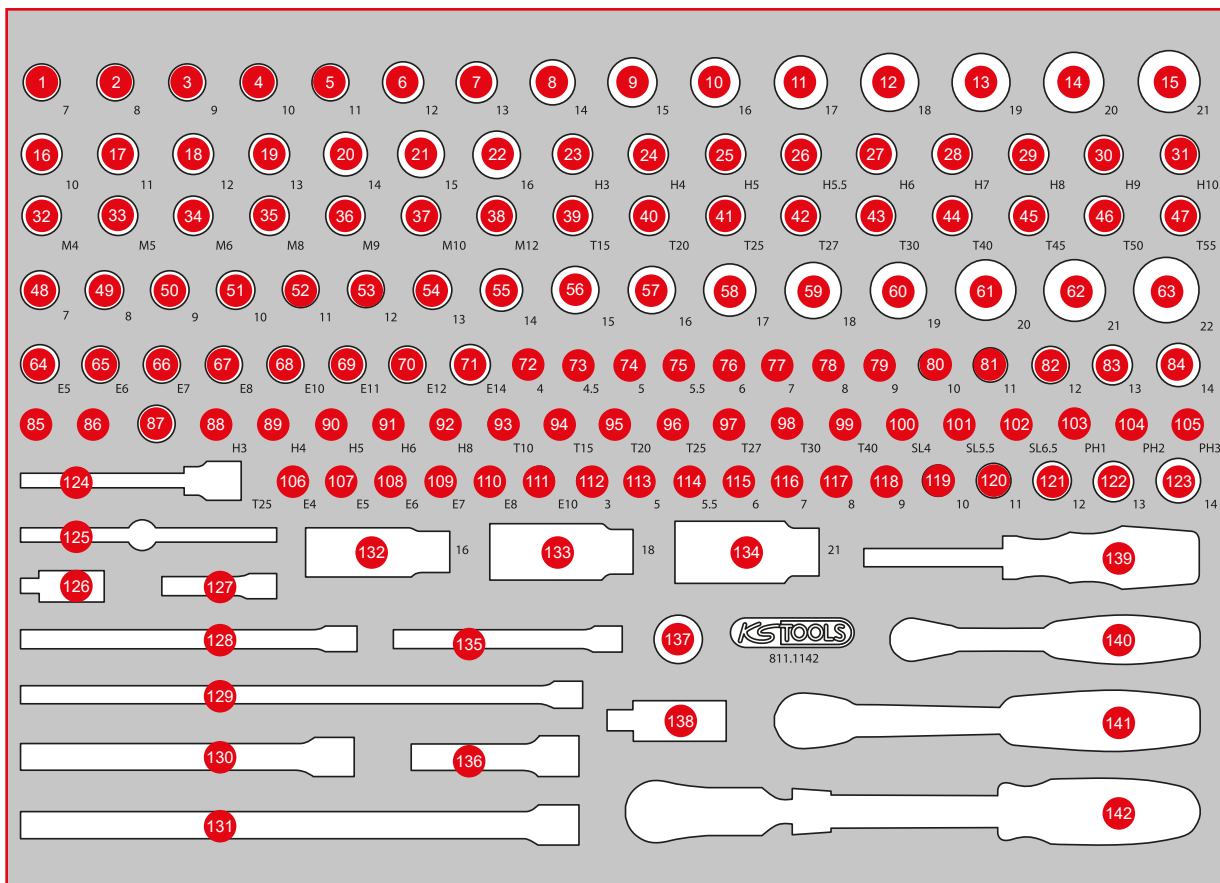

Pos.	Code	Description	pcs	Pos.	Code	Description	pcs	Pos.	Code	Description	pcs
73	917.1525	1/4" Hexagonal socket, deep, 4 mm	1	97	911.1449	1/4" Bit socket Torx, T27	1	121	917.1412	1/4" Hexagonal socket, 12 mm	1
74	917.1526	1/4" Hexagonal socket, deep, 4,5 mm	1	98	911.1446	1/4" Bit socket Torx, T30	1	122	917.1413	1/4" Hexagonal socket, 13 mm	1
75	917.1527	1/4" Hexagonal socket, deep, 5 mm	1	99	911.1447	1/4" Bit socket Torx, T40	1	123	917.1414	1/4" Hexagonal socket, 14 mm	1
76	917.1528	1/4" Hexagonal socket, deep, 5,5 mm	1	100	911.1418	1/4" Bit socket slot, 4 mm	1	124	911.1552	3/8" Bit socket Torx, long, T25	1
77	917.1426	1/4" Hexagonal socket, deep, 6 mm	1	101	911.1419	1/4" Bit socket slot, 5,5 mm	1	125	911.1425	Sliding T-bar, 1/4", 110 mm	1
78	917.1427	1/4" Hexagonal socket, deep, 7 mm	1	102	917.1421	1/4" Bit socket slot, 6,5 mm	1	126	911.1450	1/4" Universal joint	1
79	917.1428	1/4" Hexagonal socket, deep, 8 mm	1	103	911.1415	1/4" Bit socket, PH1	1	127	911.1423	1/4" Extension with hexagon drive, 50 mm	1
80	917.1429	1/4" Hexagonal socket, deep, 9 mm	1	104	911.1416	1/4" Bit socket, PH2	1	128	911.1451	1/4" Extension with hexagon drive, 150 mm	1
81	917.1430	1/4" Hexagonal socket, deep, 10 mm	1	105	911.1417	1/4" Bit socket, PH3	1	129	911.1504	1/4" Extension with hexagon drive, 250 mm	1
82	917.1431	1/4" Hexagonal socket, deep, 11 mm	1	106	911.4313	1/4" Torx E Socket, E4	1	130	911.3802	3/8" Extension with knurling, 150 mm	1
83	917.1432	1/4" Hexagonal socket, deep, 12 mm	1	107	911.4314	1/4" Torx E Socket, E5	1	131	911.3803	3/8" Extension with knurling, 250 mm	1
84	917.1433	1/4" Hexagonal socket, deep, 13 mm	1	108	911.4315	1/4" Torx E Socket, E6	1	132	911.3804	3/8" Spark plug socket, 16 mm	1
85	911.0101	1/4" socket with magnet	1	109	911.4316	1/4" Torx E Socket, E7	1	133	911.3823	3/8" Spark plug socket, 18 mm	1
86	911.1494	1/4" Adaptor, 1/4"F x 3/8"M	1	110	911.4317	1/4" Torx E Socket, E8	1	134	911.3805	3/8" Spark plug socket, 21 mm	1
87	911.3897	3/8" Reducing adaptor, 3/8"F x 1/4"M	1	111	911.4332	1/4" Torx E Socket, E10	1	135	911.1424	1/4" Extension with hexagon drive, 100 mm	1
88	911.1436	1/4" Bit socket hexagon, 3 mm	1	112	917.1445	1/4" Hexagonal socket, 3 mm	1	136	911.3801	3/8" Extension with knurling, 75 mm	1
89	911.1437	1/4" Bit socket hexagon, 4 mm	1	113	917.1405	1/4" Hexagonal socket, 5 mm	1	137	911.1233	1/2" Reducing adaptor, 1/2"F x 3/8"M	1
90	911.1438	1/4" Bit socket hexagon, 5 mm	1	114	917.14055	1/4" Hexagonal socket, 5,5 mm	1	138	911.3850	3/8" Universal joint	1
91	911.1439	1/4" Bit socket hexagon, 6 mm	1	115	917.1406	1/4" Hexagonal socket, 6 mm	1	139	911.1434	1/4" Square drive screwdriver, 150 mm	1
92	911.1441	1/4" Bit socket hexagon, 8 mm	1	116	917.1407	1/4" Hexagonal socket, 7 mm	1	140	920.1490	1/4" SlimPOWER Reversible ratchet, 72 teeth	1
93	911.1442	1/4" Bit socket Torx, T10	1	117	917.1408	1/4" Hexagonal socket, 8 mm	1	141	920.3890	3/8" SlimPOWER Reversible ratchet, 72 teeth	1
94	911.1443	1/4" Bit socket Torx, T15	1	118	917.1409	1/4" Hexagonal socket, 9 mm	1	142	914.3820	3/8" SlimPOWER Telescopic reversible ratchet, 72 teeth	1
95	911.1444	1/4" Bit socket Torx, T20	1	119	917.1410	1/4" Hexagonal socket, 10 mm	1				
96	911.1445	1/4" Bit socket Torx, T25	1	120	917.1411	1/4" Hexagonal socket, 11 mm	1				

P 10
P 15
P 20
P 25
P 30
P 35
P 40
P 45
S XL L M
Individual parts
Accessories

811.0148

M 1/4" + 3/8" socket spanner set



399, — ^{EUR}

1PCS
148

568 x 398

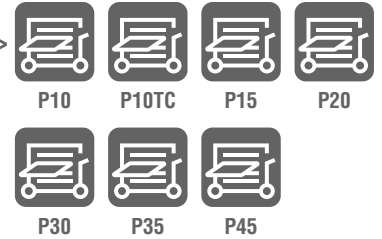

Pos.	Code	Description	pcs	Pos.	Code	Description	pcs	Pos.	Code	Description	pcs
1	911.3965	3/8" Bit socket Torx tamperproof, TB30	1	26	911.3889	3/8" Bit socket Torx, T60	1	51	917.3819	3/8" Hexagonal socket, 19 mm	1
2	911.3966	3/8" Bit socket Torx tamperproof, TB40	1	27	917.3921	3/8" RIBE® Bit socket, M4	1	52	911.1418	1/4" Bit socket slot, 4 mm	1
3	911.3967	3/8" Bit socket Torx tamperproof, TB45	1	28	917.3922	3/8" RIBE® Bit socket, M5	1	53	911.1419	1/4" Bit socket slot, 5,5 mm	1
4	911.3968	3/8" Bit socket Torx tamperproof, TB50	1	29	917.3923	3/8" RIBE® Bit socket, M6	1	54	917.1421	1/4" Bit socket slot, 6,5 mm	1
5	911.3969	3/8" Bit socket Torx tamperproof, TB55	1	30	917.3924	3/8" RIBE® Bit socket, M7	1	55	917.1541	1/4" Bit socket spline (XZN), M4	1
6	911.3970	3/8" Bit socket Torx tamperproof, TB60	1	31	917.3925	3/8" RIBE® Bit socket, M8	1	56	917.1542	1/4" Bit socket spline (XZN), M5	1
7	911.3916	3/8" Bit socket spline (XZN), M6	1	32	917.3926	3/8" RIBE® Bit socket, M9	1	57	917.1543	1/4" Bit socket spline (XZN), M6	1
8	911.3917	3/8" Bit socket spline (XZN), M8	1	33	917.3927	3/8" RIBE® Bit socket, M10	1	58	917.1545	1/4" Bit socket spline (XZN), M8	1
9	917.3901	3/8" Bit socket spline (XZN), M9	1	34	917.3928	3/8" RIBE® Bit socket, M12	1	59	911.1436	1/4" Bit socket hexagon, 3 mm	1
10	911.3920	3/8" Bit socket spline (XZN), M10	1	35	911.3892	Adaptor, 3/8" Fx1/2" M	1	60	911.1437	1/4" Bit socket hexagon, 4 mm	1
11	917.3903	3/8" Bit socket spline (XZN), M12	1	36	911.3826	3/8" Sliding / reducing adaptor, 1/2" F x 3/8" M	1	61	911.1438	1/4" Bit socket hexagon, 5 mm	1
12	911.3866	3/8" Bit socket hexagon, 6 mm	1	37	911.4342	3/8" Torx E Socket, E8	1	62	911.14385	1/4" Bit socket hexagon, 5,5 mm	1
13	911.3867	3/8" Bit socket hexagon, 7 mm	1	38	911.4318	3/8" Torx E Socket, E10	1	63	911.1439	1/4" Bit socket hexagon, 6 mm	1
14	911.3868	3/8" Bit socket hexagon, 8 mm	1	39	911.4319	3/8" Torx E Socket, E11	1	64	911.1440	1/4" Bit socket hexagon, 7 mm	1
15	917.3969	3/8" Bit socket hexagon, 9 mm	1	40	911.4320	3/8" Torx E Socket, E12	1	65	911.1441	1/4" Bit socket hexagon, 8 mm	1
16	917.3857	3/8" Bit socket hexagon, 10 mm	1	41	911.4321	3/8" Torx E Socket, E14	1	66	911.1401	1/4" Bit socket, PZ1	1
17	911.3862	3/8" Bit socket hexagon, 12 mm	1	42	917.3810	3/8" Hexagonal socket, 10 mm	1	67	911.1402	1/4" Bit socket, PZ2	1
18	911.3897	Reducing adaptor, 3/8"Fx1/4" M	1	43	917.3811	3/8" Hexagonal socket, 11 mm	1	68	911.1403	1/4" Bit socket, PZ3	1
19	911.3871	3/8" Bit socket Torx, T25	1	44	917.3812	3/8" Hexagonal socket, 12 mm	1	69	917.1578	1/4" Torx Plus bit socket 8IPR	1
20	911.3872	3/8" Bit socket Torx, T27	1	45	917.3813	3/8" Hexagonal socket, 13 mm	1	70	911.1701	1/4" Bit socket five star tamperproof, TS10	1
21	911.3873	3/8" Bit socket Torx, T30	1	46	917.3814	3/8" Hexagonal socket, 14 mm	1	71	911.1702	1/4" Bit socket five star tamperproof, TS15	1
22	911.3874	3/8" Bit socket Torx, T40	1	47	917.3815	3/8" Hexagonal socket, 15 mm	1	72	911.1703	1/4" Bit socket five star tamperproof, TS20	1
23	911.3885	3/8" Bit socket Torx, T45	1	48	917.3816	3/8" Hexagonal socket, 16 mm	1	73	911.1704	1/4" Bit socket five star tamperproof, TS25	1
24	911.3884	3/8" Bit socket Torx, T50	1	49	917.3817	3/8" Hexagonal socket, 17 mm	1	74	911.1705	1/4" Bit socket five star tamperproof, TS27	1
25	911.3888	3/8" Bit socket Torx, T55	1	50	917.3818	3/8" Hexagonal socket, 18 mm	1	75	911.1706	1/4" Bit socket five star tamperproof, TS30	1

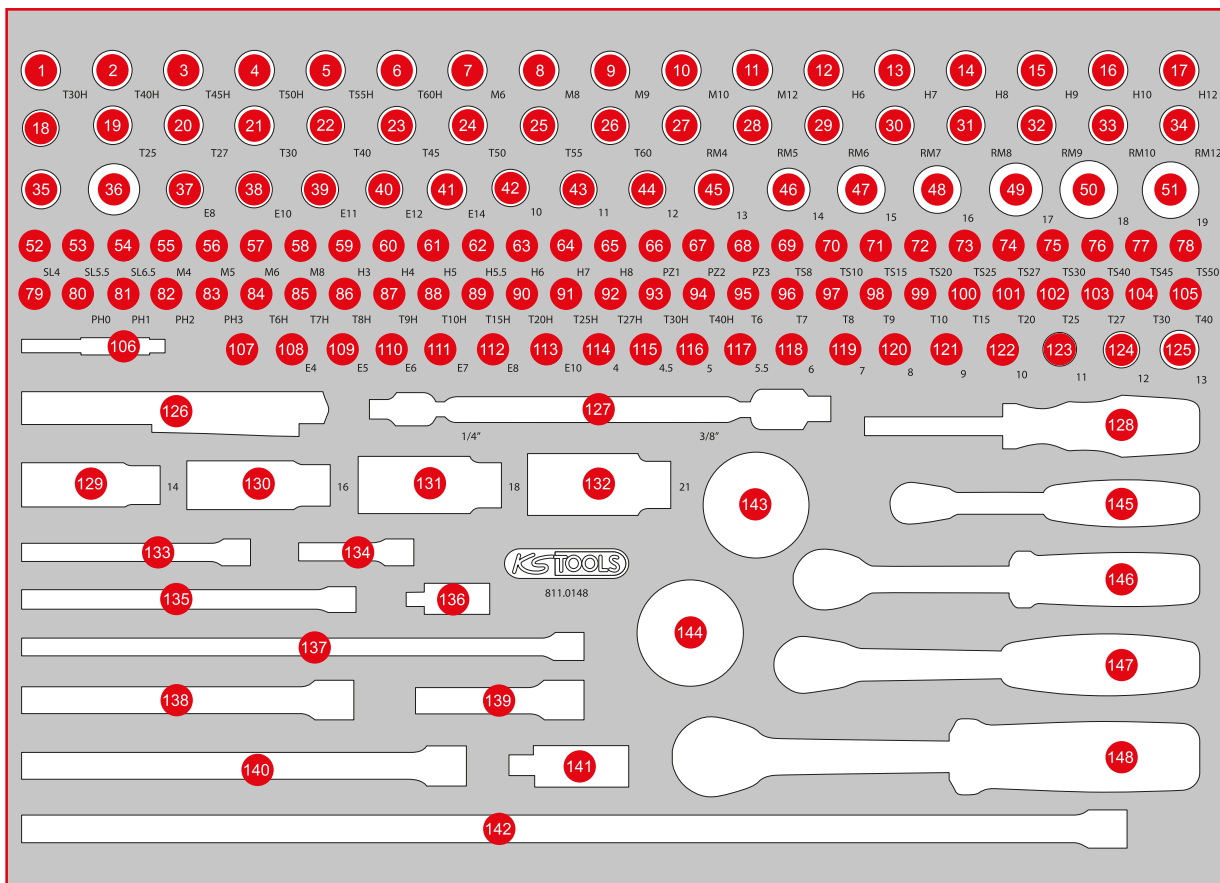

Pos.	Code	Description	pcs	Pos.	Code	Description	pcs	Pos.	Code	Description	pcs
76	911.1707	1/4" Bit socket five star tamperproof, TS40	1	101	911.1444	1/4" Bit socket Torx, T20	1	126	150.4370	perfectLight torch 85 lumen	1
77	911.1708	1/4" Bit socket five star tamperproof, TS45	1	102	911.1445	1/4" Bit socket Torx, T25	1	127	517.0338	Double-joint-spanner for 1/4" and 3/8" sockets	1
78	911.1709	1/4" Bit socket five star tamperproof, TS50	1	103	911.1449	1/4" Bit socket Torx, T27	1	128	911.1434	1/4" Square drive screwdriver, 150 mm	1
79	911.1494	Adaptor, 1/4" Mx3/8" F	1	104	911.1446	1/4" Bit socket Torx, T30	1	129	911.3990	3/8" Special spark plug socket, thin-walled, 14mm	1
80	911.1482	1/4" Bit socket, PH0	1	105	911.1447	1/4" Bit socket Torx, T40	1	130	911.3804	3/8" Spark plug socket, 16 mm	1
81	911.1415	1/4" Bit socket, PH1	1	106	514.1106	Socket adaptor, 1/4"x1/4"	1	131	911.3823	3/8" Spark plug socket, 18 mm	1
82	911.1416	1/4" Bit socket, PH2	1	107	911.0101	1/4" socket with magnet	1	132	911.3805	3/8" Spark plug socket, 21 mm	1
83	911.1417	1/4" Bit socket, PH3	1	108	911.4313	1/4" Torx E Socket, E4	1	133	911.1424	1/4" Extension with hexagon drive, 100 mm	1
84	917.1456	1/4" Bit socket Torx tamperproof, TB6	1	109	911.4314	1/4" Torx E Socket, E5	1	134	911.1423	1/4" Extension with hexagon drive, 50 mm	1
85	917.1457	1/4" Bit socket Torx tamperproof, TB7	1	110	911.4315	1/4" Torx E Socket, E6	1	135	911.1451	1/4" Extension with hexagon drive, 150 mm	1
86	911.1461	1/4" Bit socket Torx tamperproof, TB8	1	111	911.4316	1/4" Torx E Socket, E7	1	136	911.1450	1/4" Universal joint	1
87	911.1485	1/4" Bit socket Torx tamperproof, TB9	1	112	911.4317	1/4" Torx E Socket, E8	1	137	911.1543	1/4" Wobble extension with hexagon drive, 250 mm	1
88	911.1462	1/4" Bit socket Torx tamperproof, TB10	1	113	911.4332	1/4" Torx E Socket, E10	1	138	911.3802	3/8" Extension with knurling, 150 mm	1
89	911.1463	1/4" Bit socket Torx tamperproof, TB15	1	114	917.1404	1/4" Hexagonal socket, 4 mm	1	139	911.3801	3/8" Extension with knurling, 75 mm	1
90	911.1464	1/4" Bit socket Torx tamperproof, TB20	1	115	917.14045	1/4" Hexagonal socket, 4,5 mm	1	140	911.3856	3/8" Extension with knurling, 200 mm	1
91	911.1465	1/4" Bit socket Torx tamperproof, TB25	1	116	917.1405	1/4" Hexagonal socket, 5 mm	1	141	911.3850	3/8" Universal joint	1
92	911.1466	1/4" Bit socket Torx tamperproof, TB27	1	117	917.14055	1/4" Hexagonal socket, 5,5 mm	1	142	920.1490	1/4" SlimPOWER Reversible ratchet, 72 teeth	1
93	911.1467	1/4" Bit socket Torx tamperproof, TB30	1	118	917.1406	1/4" Hexagonal socket, 6 mm	1	142	911.4891	Extension, 3/8", 450mm	1
94	911.1468	1/4" Bit socket Torx tamperproof, TB40	1	119	917.1407	1/4" Hexagonal socket, 7 mm	1	143	914.1410	Mini hand reversible ratchet, 1/4", 72 teethh	1
95	911.4407	1/4" Bit socket Torx, T6	1	120	917.1408	1/4" Hexagonal socket, 8 mm	1	144	914.3810	Mini hand reversible ratchet, 3/8", 72 teethh	1
96	911.4362	1/4" Bit socket Torx, T7	1	121	917.1409	1/4" Hexagonal socket, 9 mm	1	146	914.1425	Twister-ratchet-handle, 1/4", 60 teeth	1
97	911.1448	1/4" Bit socket Torx, T8	1	122	917.1410	1/4" Hexagonal socket, 10 mm	1	147	920.3890	3/8" SlimPOWER Reversible ratchet, 72 teeth	1
98	911.1478	1/4" Bit socket Torx, T9	1	123	917.1411	1/4" Hexagonal socket, 11 mm	1	148	914.3825	Twister-ratchet-handle, 3/8", 60 teeth	1
99	911.1442	1/4" Bit socket Torx, T10	1	124	917.1412	1/4" Hexagonal socket, 12 mm	1				
100	911.1443	1/4" Bit socket Torx, T15	1	125	917.1413	1/4" Hexagonal socket, 13 mm	1				

P 10
P 15
P 20
P 25
P 30
P 35
P 40
P 45
S
XL
L
M
Individual parts
Accessories

811.0156

M 1/4" + 3/8" socket spanner set

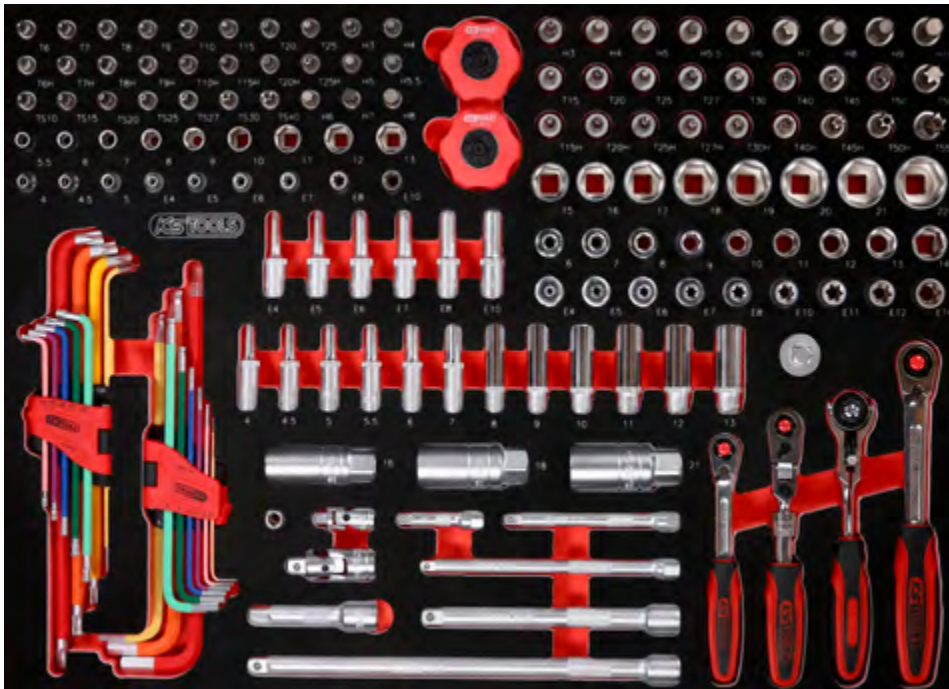

339, ^{EUR}-

1PCS
156

568 x 398

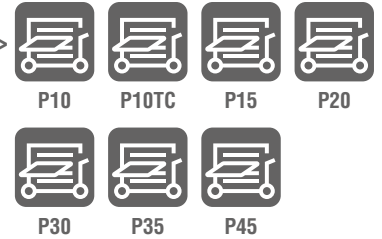

Pos.	Code	Description	pcs	Pos.	Code	Description	pcs	Pos.	Code	Description	pcs
1	920.3890	3/8" SlimPOWER Reversible ratchet, 72 teeth	1	22	917.1527	1/4" Hexagonal socket, deep, 5 mm	1	46	917.1410	1/4" Hexagonal socket, 10 mm	1
2	914.1405	1/4" MODIFIX mini T-handle swivel head ratchet, 72 teeth	1	23	917.1528	1/4" Hexagonal socket, deep, 5,5 mm	1	47	917.1411	1/4" Hexagonal socket, 11 mm	1
3	914.1420	1/4" SlimPOWER telescopic-joint reversible ratchet, 72 teeth	1	24	917.1426	1/4" Hexagonal socket, deep, 6 mm	1	48	917.1412	1/4" Hexagonal socket, 12 mm	1
4	920.1490	1/4" SlimPOWER Reversible ratchet, 72 teeth	1	25	917.1427	1/4" Hexagonal socket, deep, 7 mm	1	49	917.1413	1/4" Hexagonal socket, 13 mm	1
5	911.1423	1/4" Extension with hexagon drive, 50 mm	1	26	917.1428	1/4" Hexagonal socket, deep, 8 mm	1	50	911.4313	1/4" Torx E Socket, E4	1
6	911.1424	1/4" Extension with hexagon drive, 100 mm	1	27	917.1429	1/4" Hexagonal socket, deep, 9 mm	1	51	911.4314	1/4" Torx E Socket, E5	1
7	911.1451	1/4" Extension with hexagon drive, 150 mm	1	28	917.1430	1/4" Hexagonal socket, deep, 10 mm	1	52	911.4315	1/4" Torx E Socket, E6	1
8	911.3801	3/8" Extension with knurling, 75 mm	1	29	917.1431	1/4" Hexagonal socket, deep, 11 mm	1	53	911.4316	1/4" Torx E Socket, E7	1
9	911.3802	3/8" Extension with knurling, 150 mm	1	30	917.1432	1/4" Hexagonal socket, deep, 12 mm	1	54	911.4317	1/4" Torx E Socket, E8	1
10	911.3803	3/8" Extension with knurling, 250 mm	1	31	917.1433	1/4" Hexagonal socket, deep, 13 mm	1	55	911.4332	1/4" Torx E Socket, E10	1
11	911.1450	1/4" Universal joint	1	32	917.2401	1/4" Torx E Socket, deep, E4	1	56	911.4407	1/4" Bit socket Torx, T6	1
12	911.3850	3/8" Universal joint	1	33	917.2402	1/4" Torx E Socket, deep, E5	1	57	911.4362	1/4" Bit socket Torx, T7	1
13	911.0101	1/4" socket with magnet	1	34	917.2403	1/4" Torx E Socket, deep, E6	1	58	911.1448	1/4" Bit socket Torx, T8	1
14	911.3804	3/8" Spark plug socket, 16 mm	1	35	917.2404	1/4" Torx E Socket, deep, E7	1	59	911.1478	1/4" Bit socket Torx, T9	1
15	911.3823	3/8" Spark plug socket, 18 mm	1	36	917.2405	1/4" Torx E Socket, deep, E8	1	60	911.1442	1/4" Bit socket Torx, T10	1
16	911.3805	3/8" Spark plug socket, 21 mm	1	37	917.2406	1/4" Torx E Socket, deep, E10	1	61	911.1443	1/4" Bit socket Torx, T15	1
17	911.3826	3/8" Sliding / reducing adaptor, 1/2" F x 3/8" M	1	38	917.1404	1/4" Hexagonal socket, 4 mm	1	62	911.1444	1/4" Bit socket Torx, T20	1
18	151.4530	Ball ended Torx key wrench set, extra long and bent 108°, 9 pcs	9	39	917.14045	1/4" Hexagonal socket, 4,5 mm	1	63	911.1445	1/4" Bit socket Torx, T25	1
19	151.4420	Ball ended hexagon key wrench set, extra long, 9 pcs	9	40	917.1405	1/4" Hexagonal socket, 5 mm	1	64	917.1456	1/4" Bit socket Torx tamperproof, TB6	1
20	917.1525	1/4" Hexagonal socket, deep, 4 mm	1	41	917.14055	1/4" Hexagonal socket, 5,5 mm	1	65	917.1457	1/4" Bit socket Torx tamperproof, TB7	1
21	917.1526	1/4" Hexagonal socket, deep, 4,5 mm	1	42	917.1406	1/4" Hexagonal socket, 6 mm	1	66	911.1461	1/4" Bit socket Torx tamperproof, TB8	1
				43	917.1407	1/4" Hexagonal socket, 7 mm	1	67	911.1485	1/4" Bit socket Torx tamperproof, TB9	1
				44	917.1408	1/4" Hexagonal socket, 8 mm	1	68	911.1462	1/4" Bit socket Torx tamperproof, TB10	1
				45	917.1409	1/4" Hexagonal socket, 9 mm	1	69	911.1463	1/4" Bit socket Torx tamperproof, TB15	1

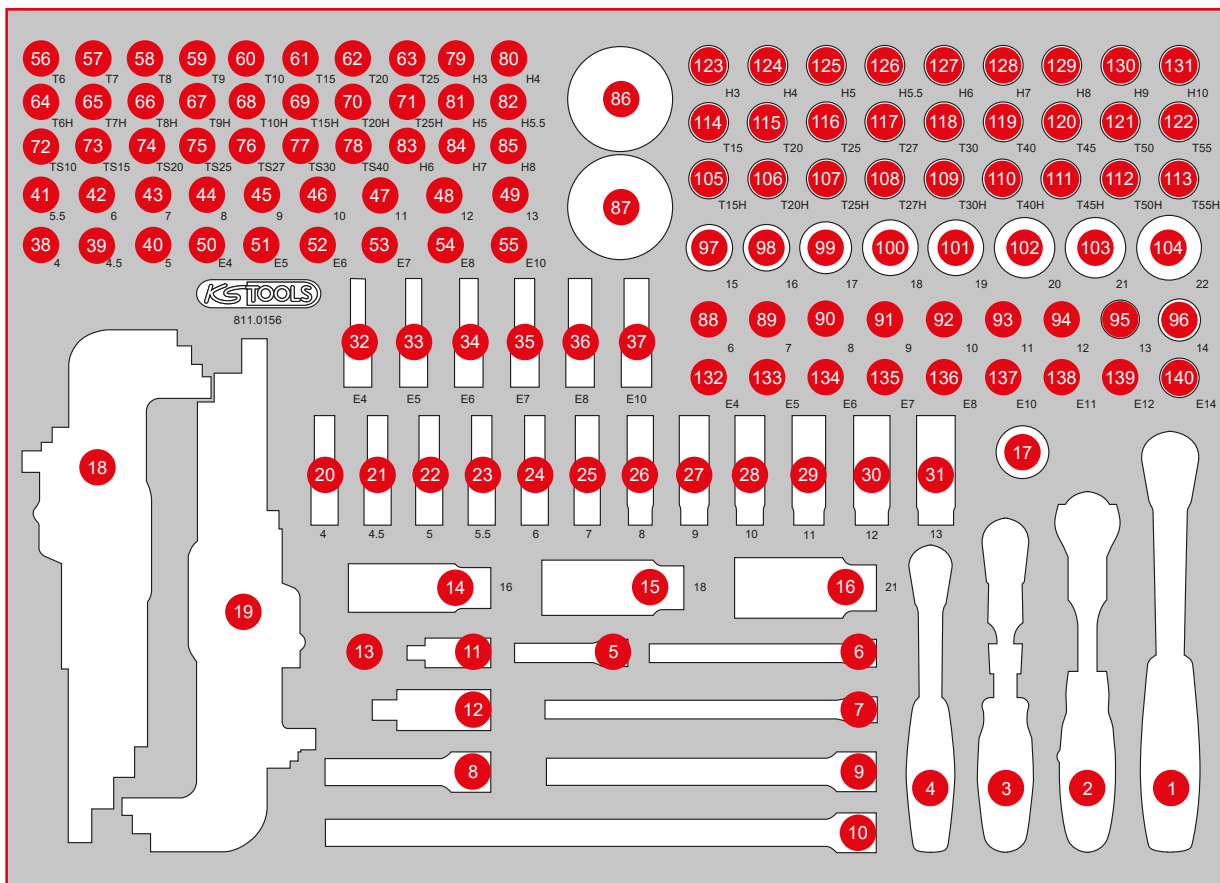

Pos.	Code	Description	pcs	Pos.	Code	Description	pcs	Pos.	Code	Description	pcs
70	911.1464	1/4" Bit socket Torx tamperproof, TB20	1	94	917.3812	3/8" Hexagonal socket, 12 mm	1	118	911.3873	3/8" Bit socket Torx, T30	1
71	911.1465	1/4" Bit socket Torx tamperproof, TB25	1	95	917.3813	3/8" Hexagonal socket, 13 mm	1	119	911.3874	3/8" Bit socket Torx, T40	1
72	911.1701	1/4" Bit socket five star tamperproof, TS10	1	96	917.3814	3/8" Hexagonal socket, 14 mm	1	120	911.3885	3/8" Bit socket Torx, T45	1
73	911.1702	1/4" Bit socket five star tamperproof, TS15	1	97	917.3815	3/8" Hexagonal socket, 15 mm	1	121	911.3884	3/8" Bit socket Torx, T50	1
74	911.1703	1/4" Bit socket five star tamperproof, TS20	1	98	917.3816	3/8" Hexagonal socket, 16 mm	1	122	911.3888	3/8" Bit socket Torx, T55	1
75	911.1704	1/4" Bit socket five star tamperproof, TS25	1	99	917.3817	3/8" Hexagonal socket, 17 mm	1	123	911.3863	3/8" Bit socket hexagon, 3 mm	1
76	911.1705	1/4" Bit socket five star tamperproof, TS27	1	100	917.3818	3/8" Hexagonal socket, 18 mm	1	124	911.3864	3/8" Bit socket hexagon, 4 mm	1
77	911.1706	1/4" Bit socket five star tamperproof, TS30	1	101	917.3819	3/8" Hexagonal socket, 19 mm	1	125	911.3865	3/8" Bit socket hexagon, 5 mm	1
78	911.1707	1/4" Bit socket five star tamperproof, TS40	1	102	917.3820	3/8" Hexagonal socket, 20 mm	1	126	911.38655	3/8" Bit socket hexagon, 5,5 mm	1
79	911.1436	1/4" Bit socket hexagon, 3 mm	1	103	917.3821	3/8" Hexagonal socket, 21 mm	1	127	911.3866	3/8" Bit socket hexagon, 6 mm	1
80	911.1437	1/4" Bit socket hexagon, 4 mm	1	104	917.3822	3/8" Hexagonal socket, 22 mm	1	128	911.3867	3/8" Bit socket hexagon, 7 mm	1
81	911.1438	1/4" Bit socket hexagon, 5 mm	1	105	911.3961	3/8" Bit socket Torx tamperproof, TB15	1	129	911.3868	3/8" Bit socket hexagon, 8 mm	1
82	911.14385	1/4" Bit socket hexagon, 5,5 mm	1	106	911.3962	3/8" Bit socket Torx tamperproof, TB20	1	130	917.3969	3/8" Bit socket hexagon, 9 mm	1
83	911.1439	1/4" Bit socket hexagon, 6 mm	1	107	911.3963	3/8" Bit socket Torx tamperproof, TB25	1	131	917.3857	3/8" Bit socket hexagon, 10 mm	1
84	911.1440	1/4" Bit socket hexagon, 7 mm	1	108	911.3964	3/8" Bit socket Torx tamperproof, TB27	1	132	911.4338	3/8" Torx E Socket, E4	1
85	911.1441	1/4" Bit socket hexagon, 8 mm	1	109	911.3965	3/8" Bit socket Torx tamperproof, TB30	1	133	911.4339	3/8" Torx E Socket, E5	1
86	914.1410	Mini hand reversible ratchet, 1/4", 72 teethh	1	110	911.3966	3/8" Bit socket Torx tamperproof, TB40	1	134	911.4340	3/8" Torx E Socket, E6	1
87	914.3810	Mini hand reversible ratchet, 3/8", 72 teethh	1	111	911.3967	3/8" Bit socket Torx tamperproof, TB45	1	135	911.4341	3/8" Torx E Socket, E7	1
88	917.3806	3/8" Hexagonal socket, 6 mm	1	112	911.3968	3/8" Bit socket Torx tamperproof, TB50	1	136	911.4342	3/8" Torx E Socket, E8	1
89	917.3807	3/8" Hexagonal socket, 7 mm	1	113	911.3969	3/8" Bit socket Torx tamperproof, TB55	1	137	911.4318	3/8" Torx E Socket, E10	1
90	917.3808	3/8" Hexagonal socket, 8 mm	1	114	911.3869	3/8" Bit socket Torx, T15	1	138	911.4319	3/8" Torx E Socket, E11	1
91	917.3809	3/8" Hexagonal socket, 9 mm	1	115	911.3870	3/8" Bit socket Torx, T20	1	139	911.4320	3/8" Torx E Socket, E12	1
92	917.3810	3/8" Hexagonal socket, 10 mm	1	116	911.3871	3/8" Bit socket Torx, T25	1	140	911.4321	3/8" Torx E Socket, E14	1
93	917.3811	3/8" Hexagonal socket, 11 mm	1	117	911.3872	3/8" Bit socket Torx, T27	1				

P 10
P 15
P 20
P 25
P 30
P 35
P 40
P 45
Individual parts S XL L M
Accessories

811.1137

M 1/4" + 1/2" socket spanner set



319,^{EUR}-

1PCS
137

568 x 398

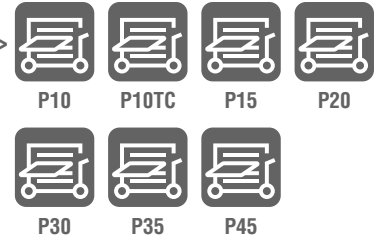

Pos.	Code	Description	pcs	Pos.	Code	Description	pcs	Pos.	Code	Description	pcs
1	911.1234	Adaptor, 1/2" F x 3/4" M	1	22	917.1220	1/2" Hexagonal socket, 20 mm	1	43	911.4322	1/2" Torx E Socket, E16	1
2	911.1341	1/2" Bit socket spline (XZN), M6, 55 mm	1	23	917.1221	1/2" Hexagonal socket, 21 mm	1	44	911.4323	1/2" Torx E Socket, E18	1
3	911.1342	1/2" Bit socket spline (XZN), M8, 55 mm	1	24	917.1222	1/2" Hexagonal socket, 22 mm	1	45	911.4324	1/2" Torx E Socket, E20	1
4	911.1343	1/2" Bit socket spline (XZN), M10, 55 mm	1	25	917.1223	1/2" Hexagonal socket, 23 mm	1	46	911.4326	1/2" Torx E Socket, E24	1
5	911.1365	1/2" Bit socket Torx, T40	1	26	917.1224	1/2" Hexagonal socket, 24 mm	1	47	911.1436	1/4" Bit socket hexagon, 3 mm	1
6	911.1366	1/2" Bit socket Torx, T45	1	27	917.1342	1/2" Hexagonal socket, 25 mm	1	48	911.1437	1/4" Bit socket hexagon, 4 mm	1
7	911.1367	1/2" Bit socket Torx, T50	1	28	917.1343	1/2" Hexagonal socket, 26 mm	1	49	911.1438	1/4" Bit socket hexagon, 5 mm	1
8	911.1368	1/2" Bit socket Torx, T55	1	29	917.1227	1/2" Hexagonal socket, 27 mm	1	50	911.1439	1/4" Bit socket hexagon, 6 mm	1
9	911.1369	1/2" Bit socket Torx, T60	1	30	917.1344	1/2" Hexagonal socket, 28 mm	1	51	911.1440	1/4" Bit socket hexagon, 7 mm	1
10	911.1305	1/2" Bit socket hexagon, short, 5 mm	1	31	917.1230	1/2" Hexagonal socket, 30 mm	1	52	911.1441	1/4" Bit socket hexagon, 8 mm	1
11	911.1306	1/2" Bit socket hexagon, short, 6 mm	1	32	917.1232	1/2" Hexagonal socket, 32 mm	1	53	911.4407	1/4" Bit socket Torx, T6	1
12	911.1307	1/2" Bit socket hexagon, short, 7 mm	1	33	917.1216	1/2" Hexagonal socket, 16 mm	1	54	911.4362	1/4" Bit socket Torx, T7	1
13	911.1308	1/2" Bit socket hexagon, short, 8 mm	1	34	917.1215	1/2" Hexagonal socket, 15 mm	1	55	911.1448	1/4" Bit socket Torx, T8	1
14	911.1310	1/2" Bit socket hexagon, short, 10 mm	1	35	917.1214	1/2" Hexagonal socket, 14 mm	1	56	911.1478	1/4" Bit socket Torx, T9	1
15	911.1312	1/2" Bit socket hexagon, short, 12 mm	1	36	917.1213	1/2" Hexagonal socket, 13 mm	1	57	911.1442	1/4" Bit socket Torx, T10	1
16	911.1314	1/2" Bit socket hexagon, short, 14 mm	1	37	917.1212	1/2" Hexagonal socket, 12 mm	1	58	911.1443	1/4" Bit socket Torx, T15	1
17	911.1317	1/2" Bit socket hexagon, short, 17 mm	1	38	917.1211	1/2" Hexagonal socket, 11 mm	1	59	911.1444	1/4" Bit socket Torx, T20	1
18	911.1319	1/2" Bit socket hexagon, short, 19 mm	1	39	917.1210	1/2" Hexagonal socket, 10 mm	1	60	911.1445	1/4" Bit socket Torx, T25	1
19	917.1217	1/2" Hexagonal socket, 17 mm	1	40	911.4334	1/2" Torx E Socket, E11	1	61	911.1449	1/4" Bit socket Torx, T27	1
20	917.1218	1/2" Hexagonal socket, 18 mm	1	41	911.4335	1/2" Torx E Socket, E12	1	62	911.1446	1/4" Bit socket Torx, T30	1
21	917.1219	1/2" Hexagonal socket, 19 mm	1	42	911.4336	1/2" Torx E Socket, E14	1	63	911.1447	1/4" Bit socket Torx, T40	1

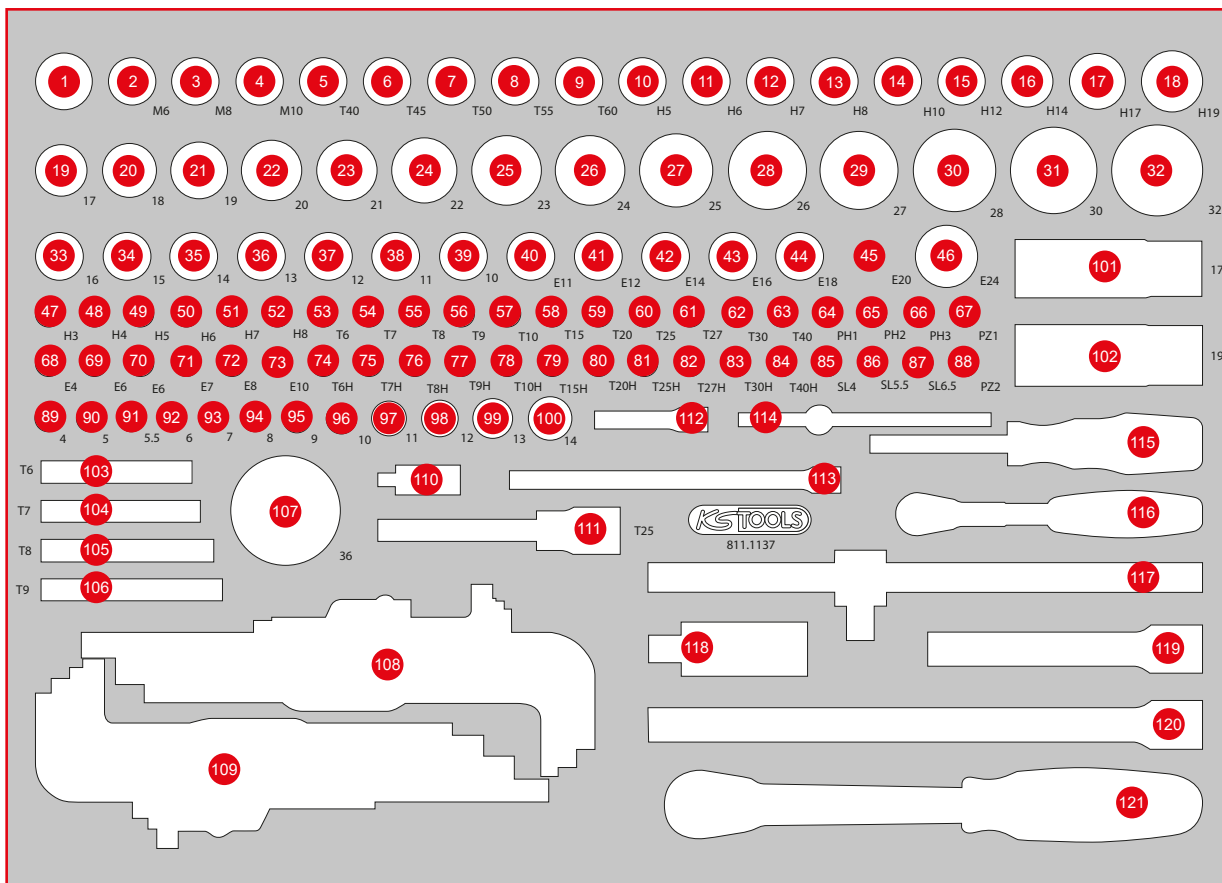

Pos.	Code	Description	pcs	Pos.	Code	Description	pcs	Pos.	Code	Description	pcs
64	911.1415	1/4" Bit socket, PH1	1	85	911.1418	1/4" Bit socket slot, 4 mm	1	106	151.2344	Torx key wrench, short, T9	1
65	911.1416	1/4" Bit socket, PH2	1	86	911.1419	1/4" Bit socket slot, 5,5 mm	1	107	911.3548	3/4" 12 Point socket, short, 36 mm	1
66	911.1417	1/4" Bit socket, PH3	1	87	917.1421	1/4" Bit socket slot, 6,5 mm	1	108	151.4530	Ball ended Torx key wrench set, extra long and bent 108°, 9 pcs	9
67	911.1401	1/4" Bit socket, PZ1	1	88	911.1402	1/4" Bit socket, PZ2	1	109	151.4420	Ball ended hexagon key wrench set, extra long, 9 pcs	9
68	911.4313	1/4" Torx E Socket, E4	1	89	917.1404	1/4" Hexagonal socket, 4 mm	1	110	911.1450	1/4" Universal joint	1
69	911.4314	1/4" Torx E Socket, E5	1	90	917.1405	1/4" Hexagonal socket, 5 mm	1	111	918.1643	1/2" CHROMEplus Bit socket Torx, long, T25	1
70	911.4315	1/4" Torx E Socket, E6	1	91	917.14055	1/4" Hexagonal socket, 5,5 mm	1	112	911.1423	1/4" Extension with hexagon drive, 50 mm	1
71	911.4316	1/4" Torx E Socket, E7	1	92	917.1406	1/4" Hexagonal socket, 6 mm	1	113	911.1451	1/4" Extension with hexagon drive, 150 mm	1
72	911.4317	1/4" Torx E Socket, E8	1	93	917.1407	1/4" Hexagonal socket, 7 mm	1	114	911.1425	Sliding T-bar, 1/4", 110 mm	1
73	911.4332	1/4" Torx E Socket, E10	1	94	917.1408	1/4" Hexagonal socket, 8 mm	1	115	911.1434	1/4" Square drive screwdriver, 150 mm	1
74	917.1456	1/4" Bit socket Torx tamperproof, TB6	1	95	917.1409	1/4" Hexagonal socket, 9 mm	1	116	920.1490	1/4" SlimPOWER Reversible ratchet, 72 teeth	1
75	917.1457	1/4" Bit socket Torx tamperproof, TB7	1	96	917.1410	1/4" Hexagonal socket, 10 mm	1	117	911.1204	Sliding T-bar, 1/2", 250 mm	1
76	911.1461	1/4" Bit socket Torx tamperproof, TB8	1	97	917.1411	1/4" Hexagonal socket, 11 mm	1	118	911.1250	1/2" Universal joint	1
77	911.1485	1/4" Bit socket Torx tamperproof, TB9	1	98	917.1412	1/4" Hexagonal socket, 12 mm	1	119	911.1202	1/2" Extensions, 125 mm	1
78	911.1462	1/4" Bit socket Torx tamperproof, TB10	1	99	917.1413	1/4" Hexagonal socket, 13 mm	1	120	911.1203	1/2" Extensions, 250 mm	1
79	911.1463	1/4" Bit socket Torx tamperproof, TB15	1	100	917.1414	1/4" Hexagonal socket, 14 mm	1	121	920.1290	1/2" SlimPOWER Reversible ratchet, 72 teeth	1
80	911.1464	1/4" Bit socket Torx tamperproof, TB20	1	101	515.0992	SlimPOWER 1/2" Alloy rim impact socket, 17mm	1				
81	911.1465	1/4" Bit socket Torx tamperproof, TB25	1	102	515.0993	SlimPOWER 1/2" Alloy rim impact socket, 19 mm	1				
82	911.1466	1/4" Bit socket Torx tamperproof, TB27	1	103	151.2341	Torx key wrench, short, T6	1				
83	911.1467	1/4" Bit socket Torx tamperproof, TB30	1	104	151.2342	Torx key wrench, short, T7	1				
84	911.1468	1/4" Bit socket Torx tamperproof, TB40	1	105	151.2343	Torx key wrench, short, T8	1				

P 10
P 15
P 20
P 25
P 30
P 35
P 40
P 45
Individual parts
S XL L M
Accessories

811.0167

M 1/4" + 1/2" socket spanner set

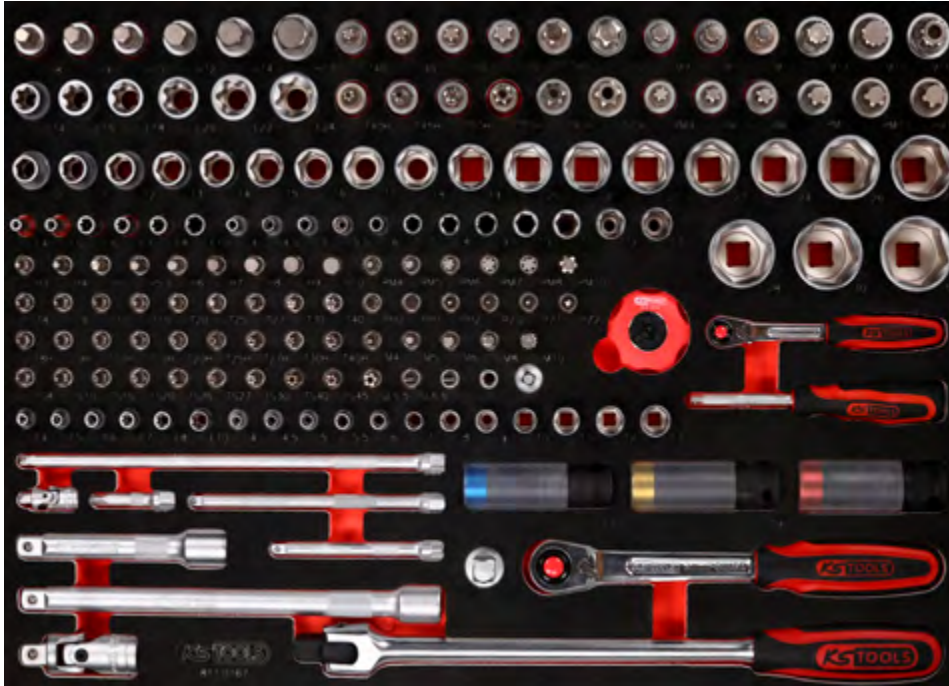

379,^{EUR}-

1PCS
167

568 x 398

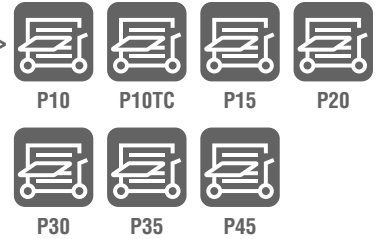

Pos.	Code	Description	pcs	Pos.	Code	Description	pcs	Pos.	Code	Description	pcs
1	911.1308	1/2" Bit socket hexagon, short, 8 mm	1	29	911.1379	1/2" Bit socket Torx tamperproof, TB60	1	58	917.2402	1/4" Torx E Socket, deep, E5	1
2	911.1309	1/2" Bit socket hexagon, short, 9 mm	1	30	911.1380	1/2" Bit socket Torx tamperproof, TB70	1	59	917.2403	1/4" Torx E Socket, deep, E6	1
3	911.1310	1/2" Bit socket hexagon, short, 10 mm	1	31	911.4515	Bit socket for RIBE screws, M9, length 55 mm	1	60	917.2404	1/4" Torx E Socket, deep, E7	1
4	911.1312	1/2" Bit socket hexagon, short, 12 mm	1	32	911.4516	Bit socket for RIBE screws, M10, Length 55 mm	1	61	917.2405	1/4" Torx E Socket, deep, E8	1
5	911.1314	1/2" Bit socket hexagon, short, 14 mm	1	33	911.4551	Bit socket for RIBE screws, M10.1, Length 55 mm	1	62	917.2406	1/4" Torx E Socket, deep, E10	1
6	911.1317	1/2" Bit socket hexagon, short, 17 mm	1	34	911.4517	Bit socket for RIBE screws, M12, Length 55 mm	1	63	917.1525	1/4" Hexagonal socket, deep, 4 mm	1
7	911.1365	1/2" Bit socket Torx, T40	1	35	911.4518	Bit socket for RIBE screws, M13, Length 55 mm	1	64	917.1526	1/4" Hexagonal socket, deep, 4,5 mm	1
8	911.1366	1/2" Bit socket Torx, T45	1	36	911.4519	Bit socket for RIBE screws, M14, Length 55 mm	1	65	917.1527	1/4" Hexagonal socket, deep, 5 mm	1
9	911.1367	1/2" Bit socket Torx, T50	1	37	917.1210	1/2" Hexagonal socket, 10 mm	1	66	917.1528	1/4" Hexagonal socket, deep, 5,5 mm	1
10	911.1368	1/2" Bit socket Torx, T55	1	38	917.1211	1/2" Hexagonal socket, 11 mm	1	67	917.1426	1/4" Hexagonal socket, deep, 6 mm	1
11	911.1369	1/2" Bit socket Torx, T60	1	39	917.1212	1/2" Hexagonal socket, 12 mm	1	68	917.1427	1/4" Hexagonal socket, deep, 7 mm	1
12	911.1370	1/2" Bit socket Torx, T70	1	40	917.1213	1/2" Hexagonal socket, 13 mm	1	69	917.1428	1/4" Hexagonal socket, deep, 8 mm	1
13	911.1313	1/2" Bit socket spline (XZN), M9, 55 mm	1	41	917.1214	1/2" Hexagonal socket, 14 mm	1	70	917.1429	1/4" Hexagonal socket, deep, 9 mm	1
14	911.1343	1/2" Bit socket spline (XZN), M10, 55 mm	1	42	917.1215	1/2" Hexagonal socket, 15 mm	1	71	917.1430	1/4" Hexagonal socket, deep, 10 mm	1
15	911.1344	1/2" Bit socket spline (XZN), M12, 55 mm	1	43	917.1216	1/2" Hexagonal socket, 16 mm	1	72	917.1431	1/4" Hexagonal socket, deep, 11 mm	1
16	911.1345	1/2" Bit socket spline (XZN), M14, 55 mm	1	44	917.1217	1/2" Hexagonal socket, 17 mm	1	73	917.1432	1/4" Hexagonal socket, deep, 12 mm	1
17	911.1346	1/2" Bit socket spline (XZN), M16, 55 mm	1	45	917.1218	1/2" Hexagonal socket, 18 mm	1	74	917.1433	1/4" Hexagonal socket, deep, 13 mm	1
18	911.1348	1/2" Bit socket spline (XZN) tamperproof, M16, 55 mm	1	46	917.1219	1/2" Hexagonal socket, 19 mm	1	75	911.1436	1/4" Bit socket hexagon, 3 mm	1
19	911.4336	1/2" Torx E Socket, E14	1	47	917.1220	1/2" Hexagonal socket, 20 mm	1	76	911.1437	1/4" Bit socket hexagon, 4 mm	1
20	911.4322	1/2" Torx E Socket, E16	1	48	917.1221	1/2" Hexagonal socket, 21 mm	1	77	911.1438	1/4" Bit socket hexagon, 5 mm	1
21	911.4323	1/2" Torx E Socket, E18	1	49	917.1222	1/2" Hexagonal socket, 22 mm	1	78	911.14385	1/4" Bit socket hexagon, 5,5 mm	1
22	911.4324	1/2" Torx E Socket, E20	1	50	917.1223	1/2" Hexagonal socket, 23 mm	1	79	911.1439	1/4" Bit socket hexagon, 6 mm	1
23	911.4325	1/2" Torx E Socket, E22	1	51	917.1224	1/2" Hexagonal socket, 24 mm	1	80	911.1440	1/4" Bit socket hexagon, 7 mm	1
24	911.4326	1/2" Torx E Socket, E24	1	52	917.1343	1/2" Hexagonal socket, 26 mm	1	81	911.1441	1/4" Bit socket hexagon, 8 mm	1
25	911.1375	1/2" Bit socket Torx tamperproof, TB40	1	53	917.1227	1/2" Hexagonal socket, 27 mm	1	82	917.1454	1/4" Bit socket hexagon, 9 mm	1
26	911.1376	1/2" Bit socket Torx tamperproof, TB45	1	54	917.1344	1/2" Hexagonal socket, 28 mm	1	83	917.1452	1/4" Bit socket hexagon, 10 mm	1
27	911.1377	1/2" Bit socket Torx tamperproof, TB50	1	55	917.1230	1/2" Hexagonal socket, 30 mm	1	84	917.1584	1/4" RIBE Socket M4S	1
28	911.1378	1/2" Bit socket Torx tamperproof, TB55	1	56	917.1232	1/2" Hexagonal socket, 32 mm	1	85	917.1585	1/4" RIBE Socket M5S	1
				57	917.2401	1/4" Torx E Socket, deep, E4	1	86	917.1586	1/4" RIBE Socket M6S	1

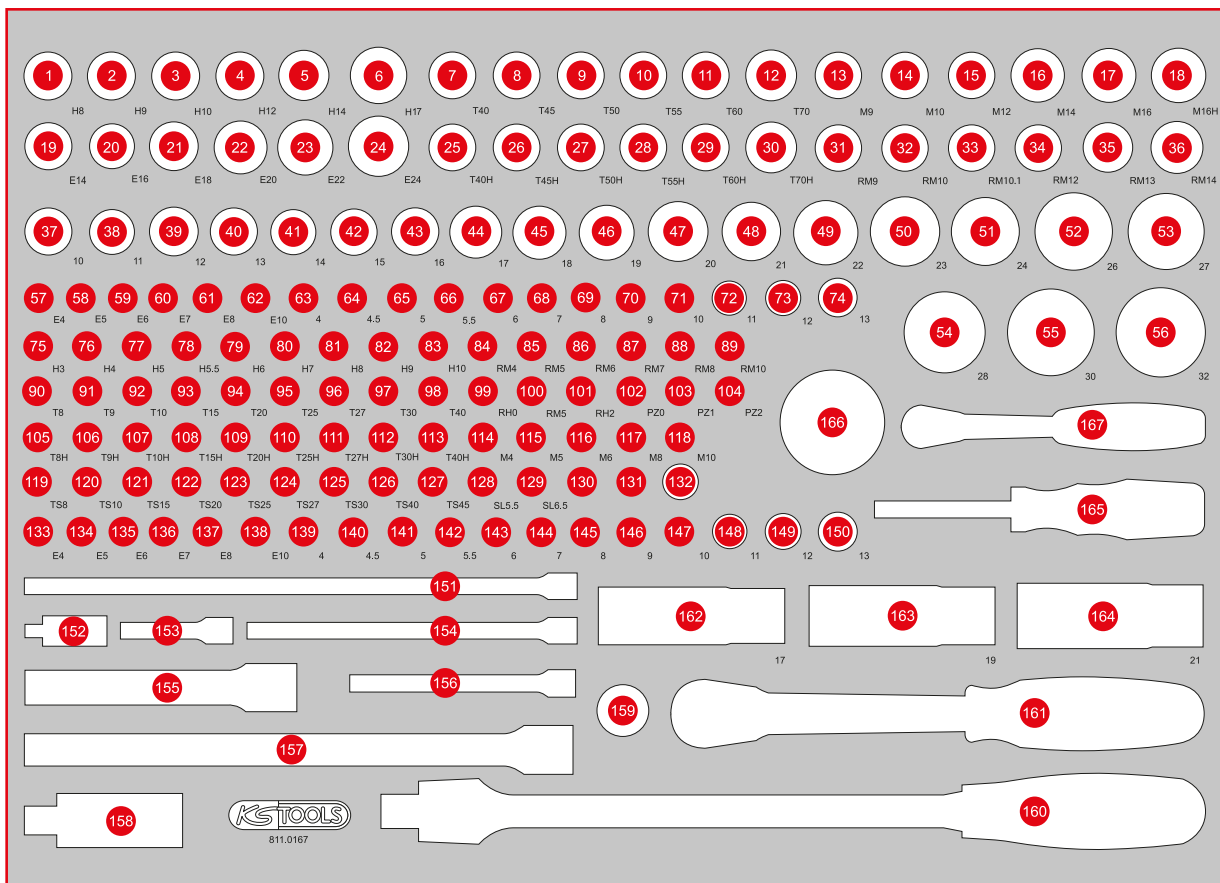

Pos.	Code	Description	pcs	Pos.	Code	Description	pcs	Pos.	Code	Description	pcs
87	917.1587	1/4" RIBE Socket M7S	1	116	917.1543	1/4" Bit socket spline (XZN), M6	1	145	917.1408	1/4" Hexagonal socket, 8 mm	1
88	917.1588	1/4" RIBE Socket M8S	1	117	917.1545	1/4" Bit socket spline (XZN), M8	1	146	917.1409	1/4" Hexagonal socket, 9 mm	1
89	917.1590	1/4" RIBE Socket M10S	1	118	917.1546	1/4" Bit socket spline (XZN), M10	1	147	917.1410	1/4" Hexagonal socket, 10 mm	1
90	911.1448	1/4" Bit socket Torx, T8	1	119	917.1578	1/4" Torx Plus bit socket 8IPR	1	148	917.1411	1/4" Hexagonal socket, 11 mm	1
91	911.1478	1/4" Bit socket Torx, T9	1	120	911.1701	1/4" Bit socket five star tamperproof, TS10	1	149	917.1412	1/4" Hexagonal socket, 12 mm	1
92	911.1442	1/4" Bit socket Torx, T10	1	121	911.1702	1/4" Bit socket five star tamperproof, TS15	1	150	917.1413	1/4" Hexagonal socket, 13 mm	1
93	911.1443	1/4" Bit socket Torx, T15	1	122	911.1703	1/4" Bit socket five star tamperproof, TS20	1	151	911.1543	1/4" Wobble extension with hexagon drive, 250 mm	1
94	911.1444	1/4" Bit socket Torx, T20	1	123	911.1704	1/4" Bit socket five star tamperproof, TS25	1	152	911.1450	1/4" Universal joint	1
95	911.1445	1/4" Bit socket Torx, T25	1	124	911.1705	1/4" Bit socket five star tamperproof, TS27	1	153	911.1423	1/4" Extension with hexagon drive, 50 mm	1
96	911.1449	1/4" Bit socket Torx, T27	1	125	911.1706	1/4" Bit socket five star tamperproof, TS30	1	154	911.1451	1/4" Extension with hexagon drive, 150 mm	1
97	911.1446	1/4" Bit socket Torx, T30	1	126	911.1707	1/4" Bit socket five star tamperproof, TS40	1	155	911.1202	1/2" Extensions, 125 mm	1
98	911.1447	1/4" Bit socket Torx, T40	1	127	911.1708	1/4" Bit socket five star tamperproof, TS45	1	156	911.1424	1/4" Extension with hexagon drive, 100 mm	1
99	911.1482	1/4" Bit socket, PH0	1	128	911.1419	1/4" Bit socket slot, 5,5 mm	1	157	911.1203	1/2" Extensions, 250 mm	1
100	911.1415	1/4" Bit socket, PH1	1	129	917.1421	1/4" Bit socket slot, 6,5 mm	1	158	911.1250	1/2" Universal joint	1
101	911.1416	1/4" Bit socket, PH2	1	130	911.0101	1/4" socket with magnet	1	159	911.1207	3/8" Sliding adaptor, 3/8" F x 1/2" M	1
102	911.1483	1/4" Bit socket, PZ0	1	131	911.1494	Adaptor, 1/4" M x 3/8" F	1	160	917.1455	1/2" Flexi head drive handle	1
103	911.1401	1/4" Bit socket, PZ1	1	132	911.3897	3/8" Reducing adaptor, 3/8" F x 1/4" M	1	161	920.1290	1/2" SlimPOWER Reversible ratchet, 72 teeth	1
104	911.1402	1/4" Bit socket, PZ2	1	133	911.4313	1/4" Torx E Socket, E4	1	162	515.0992	SlimPOWER 1/2" Alloy rim impact socket, 17mm	1
105	911.1461	1/4" Bit socket Torx tamperproof, TB8	1	134	911.4314	1/4" Torx E Socket, E5	1	163	515.0993	SlimPOWER 1/2" Alloy rim impact socket, 19 mm	1
106	911.1485	1/4" Bit socket Torx tamperproof, TB9	1	135	911.4315	1/4" Torx E Socket, E6	1	164	515.0994	SlimPOWER 1/2" Alloy rim impact socket, 21 mm	1
107	911.1462	1/4" Bit socket Torx tamperproof, TB10	1	136	911.4316	1/4" Torx E Socket, E7	1	165	911.1434	1/4" Square drive screwdriver, 150 mm	1
108	911.1463	1/4" Bit socket Torx tamperproof, TB15	1	137	911.4317	1/4" Torx E Socket, E8	1	166	914.1410	Mini hand reversible ratchet, 1/4", 72 teeth	1
109	911.1464	1/4" Bit socket Torx tamperproof, TB20	1	138	911.4332	1/4" Torx E Socket, E10	1	167	920.1490	1/4" SlimPOWER Reversible ratchet, 72 teeth	1
110	911.1465	1/4" Bit socket Torx tamperproof, TB25	1	139	917.1404	1/4" Hexagonal socket, 4 mm	1				
111	911.1466	1/4" Bit socket Torx tamperproof, TB27	1	140	917.14045	1/4" Hexagonal socket, 4,5 mm	1				
112	911.1467	1/4" Bit socket Torx tamperproof, TB30	1	141	917.1405	1/4" Hexagonal socket, 5 mm	1				
113	911.1468	1/4" Bit socket Torx tamperproof, TB40	1	142	917.14055	1/4" Hexagonal socket, 5,5 mm	1				
114	917.1541	1/4" Bit socket spline (XZN), M4	1	143	917.1406	1/4" Hexagonal socket, 6 mm	1				
115	917.1542	1/4" Bit socket spline (XZN), M5	1	144	917.1407	1/4" Hexagonal socket, 7 mm	1				

P 10
P 15
P 20
P 25
P 30
P 35
P 40
P 45
Individual parts S XL L M
Accessories

811.0124

M 3/8" Socket spanner set

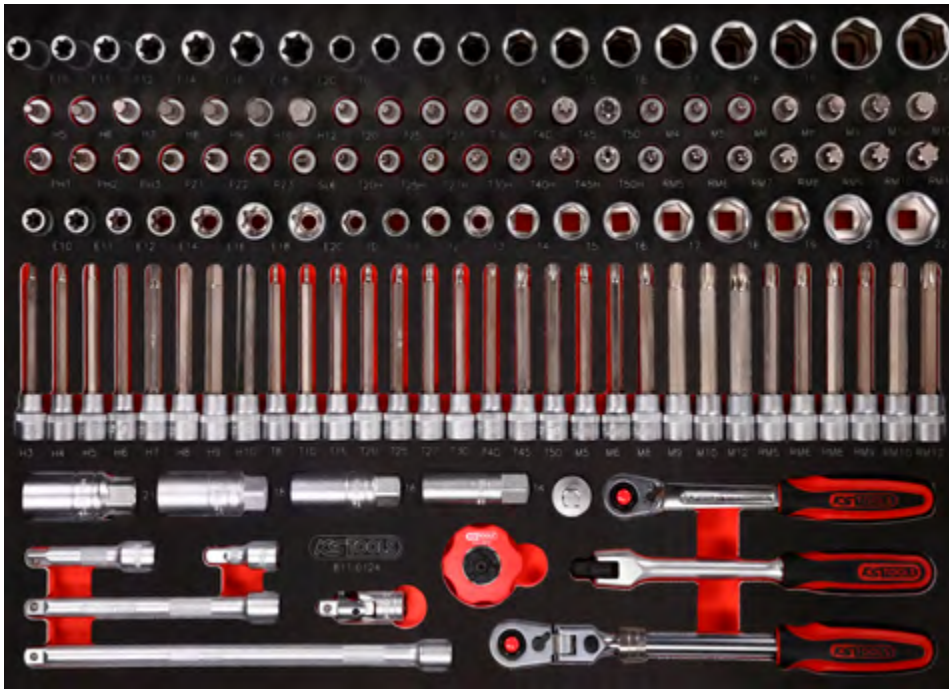

339, —^{EUR}

124

568 x 398

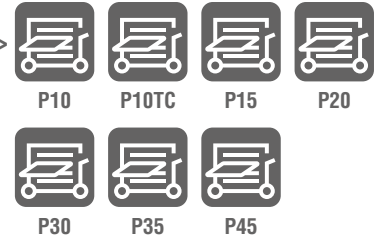

Pos.	Code	Description	pcs	Pos.	Code	Description	pcs	Pos.	Code	Description	pcs
1	914.3820	3/8" SlimPOWER Telescopic reversible ratchet, 72 teeth	1	21	917.1594	3/8" Bit socket hexagon, long, 9 mm	1	43	917.3935	3/8" RIBE® Bit socket, long, M10	1
2	917.3939	3/8" Flexi head drive handle	1	22	911.1566	3/8" Bit socket hexagon, long, 10 mm	1	44	917.3936	3/8" RIBE® Bit socket, long, M12	1
3	920.3890	3/8" SlimPOWER Reversible ratchet, 72 teeth	1	23	917.1576	3/8" Bit socket Torx, long, T8	1	45	911.4318	3/8" Torx E Socket, E10	1
4	914.3810	Mini hand reversible ratchet, 3/8", 72 teeth	1	24	917.1577	3/8" Bit socket Torx, long, T10	1	46	911.4319	3/8" Torx E Socket, E11	1
5	911.3826	3/8" Sliding / reducing adaptor, 1/2" F x 3/8" M	1	25	917.1579	3/8" Bit socket Torx, long, T15	1	47	911.4320	3/8" Torx E Socket, E12	1
6	911.3990	3/8" Special spark plug socket, thin-walled 14 mm	1	26	911.1551	3/8" Bit socket Torx, long, T20	1	48	911.4321	3/8" Torx E Socket, E14	1
7	911.3804	3/8" Spark plug socket, 16 mm	1	27	911.1552	3/8" Bit socket Torx, long, T25	1	49	911.4343	3/8" Torx E Socket, E16	1
8	911.3823	3/8" Spark plug socket, 18 mm	1	28	911.1553	3/8" Bit socket Torx, long, T27	1	50	911.4344	3/8" Torx E Socket, E18	1
9	911.3805	3/8" Spark plug socket, 21 mm	1	29	911.1554	3/8" Bit socket Torx, long, T30	1	51	911.4345	3/8" Torx E Socket, E20	1
10	911.3850	3/8" Universal joint	1	30	911.1555	3/8" Bit socket Torx, long, T40	1	52	917.3810	3/8" Hexagonal socket, 10 mm	1
11	911.3852	3/8" Extension with knurling, 45 mm	1	31	911.1556	3/8" Bit socket Torx, long, T45	1	53	917.3811	3/8" Hexagonal socket, 11 mm	1
12	911.3801	3/8" Extension with knurling, 75 mm	1	32	911.1557	3/8" Bit socket Torx, long, T50	1	54	917.3812	3/8" Hexagonal socket, 12 mm	1
13	911.3802	3/8" Extension with knurling, 150 mm	1	33	917.3904	XZN spline bit socket, 3/8", M5, long	1	55	917.3813	3/8" Hexagonal socket, 13 mm	1
14	911.3803	3/8" Extension with knurling, 250 mm	1	34	917.3905	XZN spline bit socket, 3/8", M6, long	1	56	917.3814	3/8" Hexagonal socket, 14 mm	1
15	917.1593	3/8" Bit socket hexagon, long, 3 mm	1	35	917.3906	XZN spline bit socket, 3/8", M8, long	1	57	917.3815	3/8" Hexagonal socket, 15 mm	1
16	911.1561	3/8" Bit socket hexagon, long, 4 mm	1	36	917.3907	XZN spline bit socket, 3/8", M9, long	1	58	917.3816	3/8" Hexagonal socket, 16 mm	1
17	911.1562	3/8" Bit socket hexagon, long, 5 mm	1	37	917.3908	XZN spline bit socket, 3/8", M10, long	1	59	917.3817	3/8" Hexagonal socket, 17 mm	1
18	911.1563	3/8" Bit socket hexagon, long, 6 mm	1	38	917.3909	XZN spline bit socket, 3/8", M12, long	1	60	917.3818	3/8" Hexagonal socket, 18 mm	1
19	911.1564	3/8" Bit socket hexagon, long, 7 mm	1	39	917.3930	3/8" RIBE® Bit socket, long, M5	1	61	917.3819	3/8" Hexagonal socket, 19 mm	1
20	911.1565	3/8" Bit socket hexagon, long, 8 mm	1	40	917.3931	3/8" RIBE® Bit socket, long, M6	1	62	917.3821	3/8" Hexagonal socket, 21 mm	1
				41	917.3933	3/8" RIBE® Bit socket, long, M8	1	63	917.3822	3/8" Hexagonal socket, 22 mm	1
				42	917.3934	3/8" RIBE® Bit socket, long, M9	1	64	911.3875	3/8" Bit socket, PH1	1

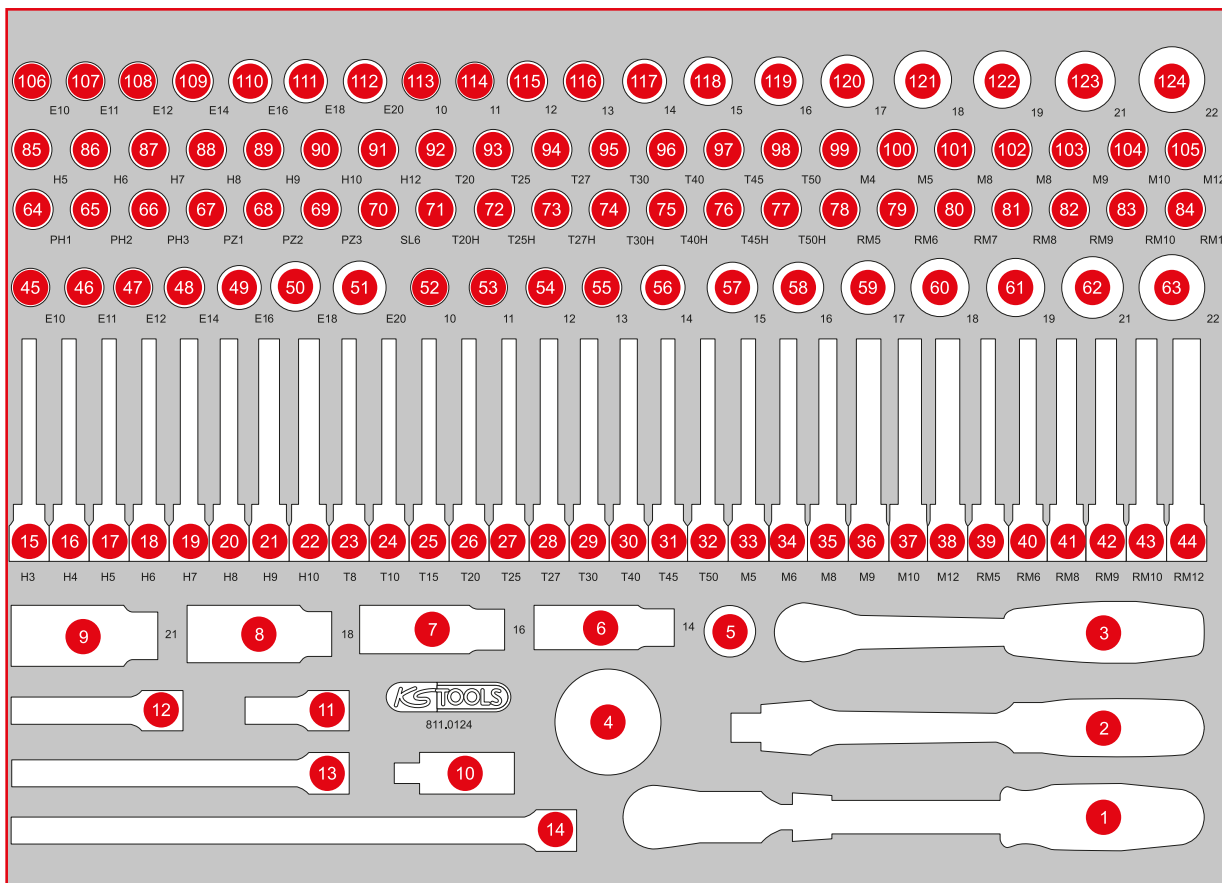

Pos.	Code	Description	pcs	Pos.	Code	Description	pcs	Pos.	Code	Description	pcs
65	911.3876	3/8" Bit socket, PH2	1	87	911.3867	3/8" Bit socket hexagon, 7 mm	1	109	911.4394	3/8" Torx E socket, E14, long	1
66	911.3877	3/8" Bit socket, PH3	1	88	911.3868	3/8" Bit socket hexagon, 8 mm	1	110	911.4396	3/8" Torx E socket, E16, long	1
67	911.3881	3/8" Bit socket, PZ1	1	89	917.3969	3/8" Bit socket hexagon, 9 mm	1	111	911.4398	3/8" Torx E socket, E18, long	1
68	911.3882	3/8" Bit socket, PZ2	1	90	917.3857	3/8" Bit socket hexagon, 10 mm	1	112	911.4399	3/8" Torx E socket, E20, long	1
69	911.3883	3/8" Bit socket, PZ3	1	91	911.3862	3/8" Bit socket hexagon, 12 mm	1	113	917.3830	3/8" Hexagonal socket, deep, 10 mm	1
70	911.3943	3/8" Bit socket slot 6 mm	1	92	911.3870	3/8" Bit socket Torx, T20	1	114	917.3831	3/8" Hexagonal socket, deep, 11 mm	1
71	911.3962	3/8" Bit socket Torx tamperproof, TB20	1	93	911.3871	3/8" Bit socket Torx, T25	1	115	917.3832	3/8" Hexagonal socket, deep, 12 mm	1
72	911.3963	3/8" Bit socket Torx tamperproof, TB25	1	94	911.3872	3/8" Bit socket Torx, T27	1	116	917.3833	3/8" Hexagonal socket, deep, 13 mm	1
73	911.3964	3/8" Bit socket Torx tamperproof, TB27	1	95	911.3873	3/8" Bit socket Torx, T30	1	117	917.3834	3/8" Hexagonal socket, deep, 14 mm	1
74	911.3965	3/8" Bit socket Torx tamperproof, TB30	1	96	911.3874	3/8" Bit socket Torx, T40	1	118	917.3835	3/8" Hexagonal socket, deep, 15 mm	1
75	911.3966	3/8" Bit socket Torx tamperproof, TB40	1	97	911.3885	3/8" Bit socket Torx, T45	1	119	917.3836	3/8" Hexagonal socket, deep, 16 mm	1
76	911.3967	3/8" Bit socket Torx tamperproof, TB45	1	98	911.3884	3/8" Bit socket Torx, T50	1	120	917.3837	3/8" Hexagonal socket, deep, 17 mm	1
77	911.3968	3/8" Bit socket Torx tamperproof, TB50	1	99	911.3918	3/8" Bit socket spline (XZN), M4	1	121	917.3838	3/8" Hexagonal socket, deep, 18 mm	1
78	917.3922	3/8" RIBE® Bit socket, M5	1	100	911.3915	3/8" Bit socket spline (XZN), M5	1	122	917.3839	3/8" Hexagonal socket, deep, 19 mm	1
79	917.3923	3/8" RIBE® Bit socket, M6	1	101	911.3916	3/8" Bit socket spline (XZN), M6	1	123	917.3841	3/8" Hexagonal socket, deep, 21 mm	1
80	917.3924	3/8" RIBE® Bit socket, M7	1	102	911.3917	3/8" Bit socket spline (XZN), M8	1	124	917.3842	3/8" Hexagonal socket, deep, 22 mm	1
81	917.3925	3/8" RIBE® Bit socket, M8	1	103	917.3901	3/8" Bit socket spline (XZN), M9	1				
82	917.3926	3/8" RIBE® Bit socket, M9	1	104	911.3920	3/8" Bit socket spline (XZN), M10	1				
83	917.3927	3/8" RIBE® Bit socket, M10	1	105	917.3903	3/8" Bit socket spline (XZN), M12	1				
84	917.3928	3/8" RIBE® Bit socket, M12	1	106	911.4390	3/8" Torx E socket, E10, long	1				
85	911.3865	3/8" Bit socket hexagon, 5 mm	1	107	911.4391	3/8" Torx E socket, E11, long	1				
86	911.3866	3/8" Bit socket hexagon, 6 mm	1	108	911.4392	3/8" Torx E socket, E12, long	1				

P 10
P 15
P 20
P 25
P 30
P 35
P 40
P 45
S
XL
L
M
Individual parts
Accessories

811.0101

M 3/8" + 1/2" Socket spanner set



269, — ^{EUR}

1PCS
101

568 x 398

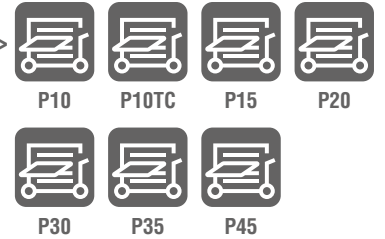

Pos.	Code	Description	pcs	Pos.	Code	Description	pcs	Pos.	Code	Description	pcs
1	917.1218	1/2" Hexagonal socket, 18 mm	1	20	917.1212	1/2" Hexagonal socket, 12 mm	1	39	917.3811	3/8" Hexagonal socket, 11 mm	1
2	917.1219	1/2" Hexagonal socket, 19 mm	1	21	917.1211	1/2" Hexagonal socket, 11 mm	1	40	917.3812	3/8" Hexagonal socket, 12 mm	1
3	917.1220	1/2" Hexagonal socket, 20 mm	1	22	917.1210	1/2" Hexagonal socket, 10 mm	1	41	917.3813	3/8" Hexagonal socket, 13 mm	1
4	917.1221	1/2" Hexagonal socket, 21 mm	1	23	917.1341	1/2" Hexagonal socket, 9 mm	1	42	917.3814	3/8" Hexagonal socket, 14 mm	1
5	917.1222	1/2" Hexagonal socket, 22 mm	1	24	917.1340	1/2" Hexagonal socket, 8 mm	1	43	917.3815	3/8" Hexagonal socket, 15 mm	1
6	917.1223	1/2" Hexagonal socket, 23 mm	1	25	911.4333	1/2" Torx E Socket, E10	1	44	917.3816	3/8" Hexagonal socket, 16 mm	1
7	917.1224	1/2" Hexagonal socket, 24 mm	1	26	911.4334	1/2" Torx E Socket, E11	1	45	917.3817	3/8" Hexagonal socket, 17 mm	1
8	917.1342	1/2" Hexagonal socket, 25 mm	1	27	911.4335	1/2" Torx E Socket, E12	1	46	917.3818	3/8" Hexagonal socket, 18 mm	1
9	917.1343	1/2" Hexagonal socket, 26 mm	1	28	911.4336	1/2" Torx E Socket, E14	1	47	917.3819	3/8" Hexagonal socket, 19 mm	1
10	917.1227	1/2" Hexagonal socket, 27 mm	1	29	911.4322	1/2" Torx E Socket, E16	1	48	917.3820	3/8" Hexagonal socket, 20 mm	1
11	917.1344	1/2" Hexagonal socket, 28 mm	1	30	911.4323	1/2" Torx E Socket, E18	1	49	917.3821	3/8" Hexagonal socket, 21 mm	1
12	917.1345	1/2" Hexagonal socket, 29 mm	1	31	911.4324	1/2" Torx E Socket, E20	1	50	917.3822	3/8" Hexagonal socket, 22 mm	1
13	917.1230	1/2" Hexagonal socket, 30 mm	1	32	911.4325	1/2" Torx E Socket, E22	1	51	911.3869	3/8" Bit socket Torx, T15	1
14	917.1232	1/2" Hexagonal socket, 32 mm	1	33	911.4326	1/2" Torx E Socket, E24	1	52	911.3870	3/8" Bit socket Torx, T20	1
15	917.1217	1/2" Hexagonal socket, 17 mm	1	34	917.3806	3/8" Hexagonal socket, 6 mm	1	53	911.3871	3/8" Bit socket Torx, T25	1
16	917.1216	1/2" Hexagonal socket, 16 mm	1	35	917.3807	3/8" Hexagonal socket, 7 mm	1	54	911.3872	3/8" Bit socket Torx, T27	1
17	917.1215	1/2" Hexagonal socket, 15 mm	1	36	917.3808	3/8" Hexagonal socket, 8 mm	1	55	911.3873	3/8" Bit socket Torx, T30	1
18	917.1214	1/2" Hexagonal socket, 14 mm	1	37	917.3809	3/8" Hexagonal socket, 9 mm	1	56	911.3874	3/8" Bit socket Torx, T40	1
19	917.1213	1/2" Hexagonal socket, 13 mm	1	38	917.3810	3/8" Hexagonal socket, 10 mm	1	57	911.3885	3/8" Bit socket Torx, T45	1

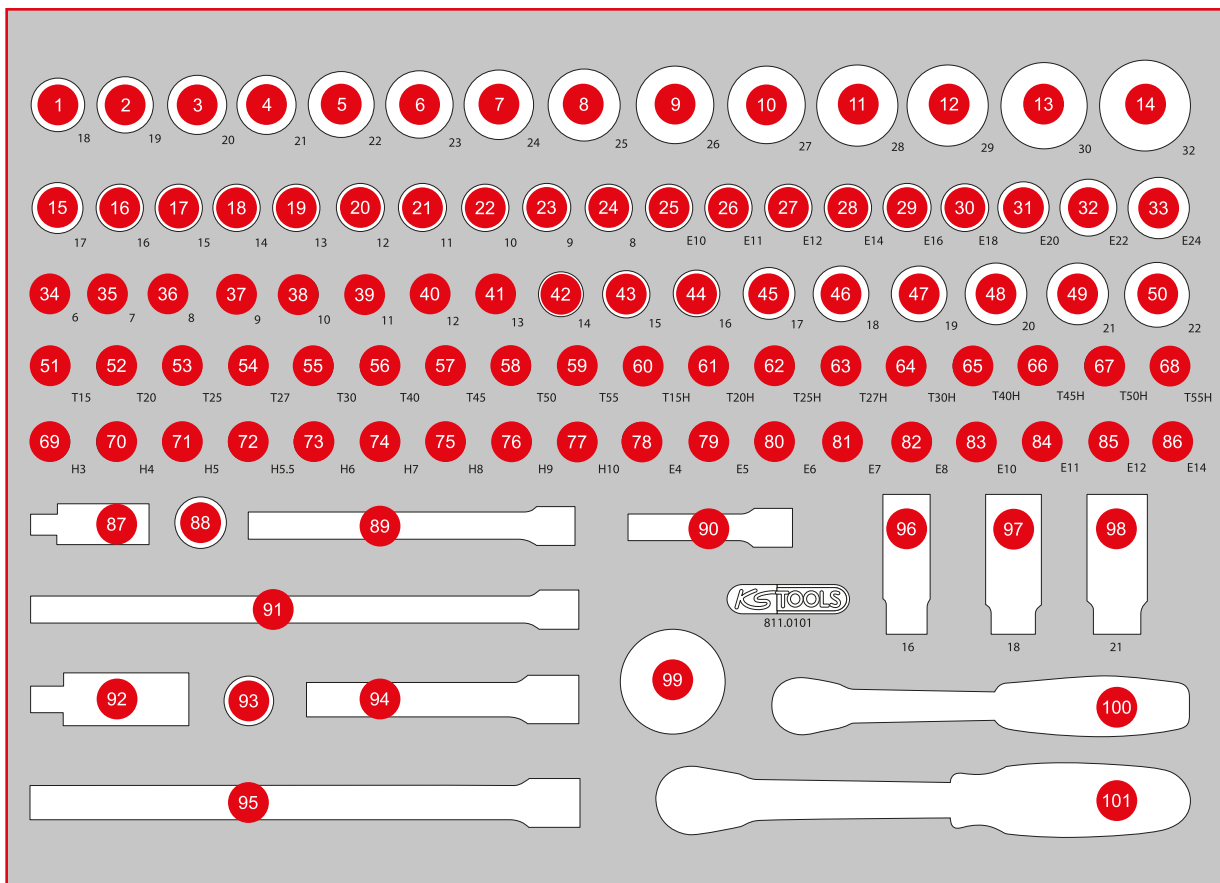

Pos.	Code	Description	pcs	Pos.	Code	Description	pcs	Pos.	Code	Description	pcs
58	911.3884	3/8" Bit socket Torx, T50	1	76	917.3969	3/8" Bit socket hexagon, 9 mm	1	94	911.1202	1/2" Extensions, 125 mm	1
59	911.3888	3/8" Bit socket Torx, T55	1	77	917.3857	3/8" Bit socket hexagon, 10 mm	1	95	911.1203	1/2" Extensions, 250 mm	1
60	911.3961	3/8" Bit socket Torx tamperproof, TB15	1	78	911.4338	3/8" Torx E Socket, E4	1	96	911.3804	3/8" Spark plug socket, 16 mm	1
61	911.3962	3/8" Bit socket Torx tamperproof, TB20	1	79	911.4339	3/8" Torx E Socket, E5	1	97	911.3823	3/8" Spark plug socket, 18 mm	1
62	911.3963	3/8" Bit socket Torx tamperproof, TB25	1	80	911.4340	3/8" Torx E Socket, E6	1	98	911.3805	3/8" Spark plug socket, 21 mm	1
63	911.3964	3/8" Bit socket Torx tamperproof, TB27	1	81	911.4341	3/8" Torx E Socket, E7	1	99	914.3810	Mini hand reversible ratchet, 3/8", 72 teeth	1
64	911.3965	3/8" Bit socket Torx tamperproof, TB30	1	82	911.4342	3/8" Torx E Socket, E8	1	100	920.3890	3/8" SlimPOWER Reversible ratchet, 72 teeth	1
65	911.3966	3/8" Bit socket Torx tamperproof, TB40	1	83	911.4318	3/8" Torx E Socket, E10	1	101	920.1290	1/2" SlimPOWER Reversible ratchet, 72 teeth	1
66	911.3967	3/8" Bit socket Torx tamperproof, TB45	1	84	911.4319	3/8" Torx E Socket, E11	1				
67	911.3968	3/8" Bit socket Torx tamperproof, TB50	1	85	911.4320	3/8" Torx E Socket, E12	1				
68	911.3969	3/8" Bit socket Torx tamperproof, TB55	1	86	911.4321	3/8" Torx E Socket, E14	1				
69	911.3863	3/8" Bit socket hexagon, 3 mm	1	87	911.3850	3/8" Universal joint	1				
70	911.3864	3/8" Bit socket hexagon, 4 mm	1	88	911.3826	3/8" Sliding / reducing adaptor, 1/2" F x 3/8" M	1				
71	911.3865	3/8" Bit socket hexagon, 5 mm	1	89	911.3802	3/8" Extension with knurling, 150 mm	1				
72	911.38655	3/8" Bit socket hexagon, 5,5 mm	1	90	911.3801	3/8" Extension with knurling, 75 mm	1				
73	911.3866	3/8" Bit socket hexagon, 6 mm	1	91	911.3803	3/8" Extension with knurling, 250 mm	1				
74	911.3867	3/8" Bit socket hexagon, 7 mm	1	92	911.1250	1/2" Universal joint	1				
75	911.3868	3/8" Bit socket hexagon, 8 mm	1	93	911.1207	3/8" Sliding adaptor, 3/8" F x 1/2" M	1				

P 10

P 15

P 20

P 25

P 30

P 35

P 40

P 45

M

L

S

XL

Individual parts

Accessories

811.0066

M 1/2" Socket spanner set



269, ^{EUR}-

66

568 x 398

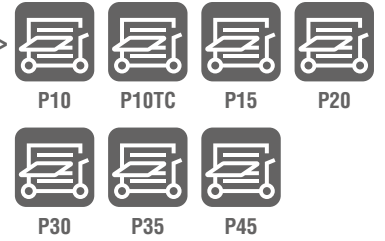

Pos.	Code	Description	pcs	Pos.	Code	Description	pcs	Pos.	Code	Description	pcs
1	911.1306	1/2" Bit socket hexagon, short, 6 mm	1	12	911.1363	1/2" Bit socket Torx, T27	1	23	911.4333	1/2" Torx E Socket, E10	1
2	911.1307	1/2" Bit socket hexagon, short, 7 mm	1	13	911.1364	1/2" Bit socket Torx, T30	1	24	911.4334	1/2" Torx E Socket, E11	1
3	911.1308	1/2" Bit socket hexagon, short, 8 mm	1	14	911.1365	1/2" Bit socket Torx, T40	1	25	911.4335	1/2" Torx E Socket, E12	1
4	911.1309	1/2" Bit socket hexagon, short, 9 mm	1	15	911.1366	1/2" Bit socket Torx, T45	1	26	911.4336	1/2" Torx E Socket, E14	1
5	911.1310	1/2" Bit socket hexagon, short, 10 mm	1	16	911.1367	1/2" Bit socket Torx, T50	1	27	911.4322	1/2" Torx E Socket, E16	1
6	911.1312	1/2" Bit socket hexagon, short, 12 mm	1	17	911.1368	1/2" Bit socket Torx, T55	1	28	911.4323	1/2" Torx E Socket, E18	1
7	911.1314	1/2" Bit socket hexagon, short, 14 mm	1	18	911.1369	1/2" Bit socket Torx, T60	1	29	911.4324	1/2" Torx E Socket, E20	1
8	911.1317	1/2" Bit socket hexagon, short, 17 mm	1	19	911.1374	1/2" Bit socket Torx tamperproof, TB30	1	30	911.4325	1/2" Torx E Socket, E22	1
9	911.1319	1/2" Bit socket hexagon, short, 19 mm	1	20	911.1375	1/2" Bit socket Torx tamperproof, TB40	1	31	911.4326	1/2" Torx E Socket, E24	1
10	911.1361	1/2" Bit socket Torx, T20	1	21	911.1376	1/2" Bit socket Torx tamperproof, TB45	1	32	911.3892	Adaptor, 3/8" Fx1/2" M	1
11	911.1362	1/2" Bit socket Torx, T25	1	22	911.1377	1/2" Bit socket Torx tamperproof, TB50	1	33	911.1233	Reducing adaptor, 1/2"F x 3/8"M	1

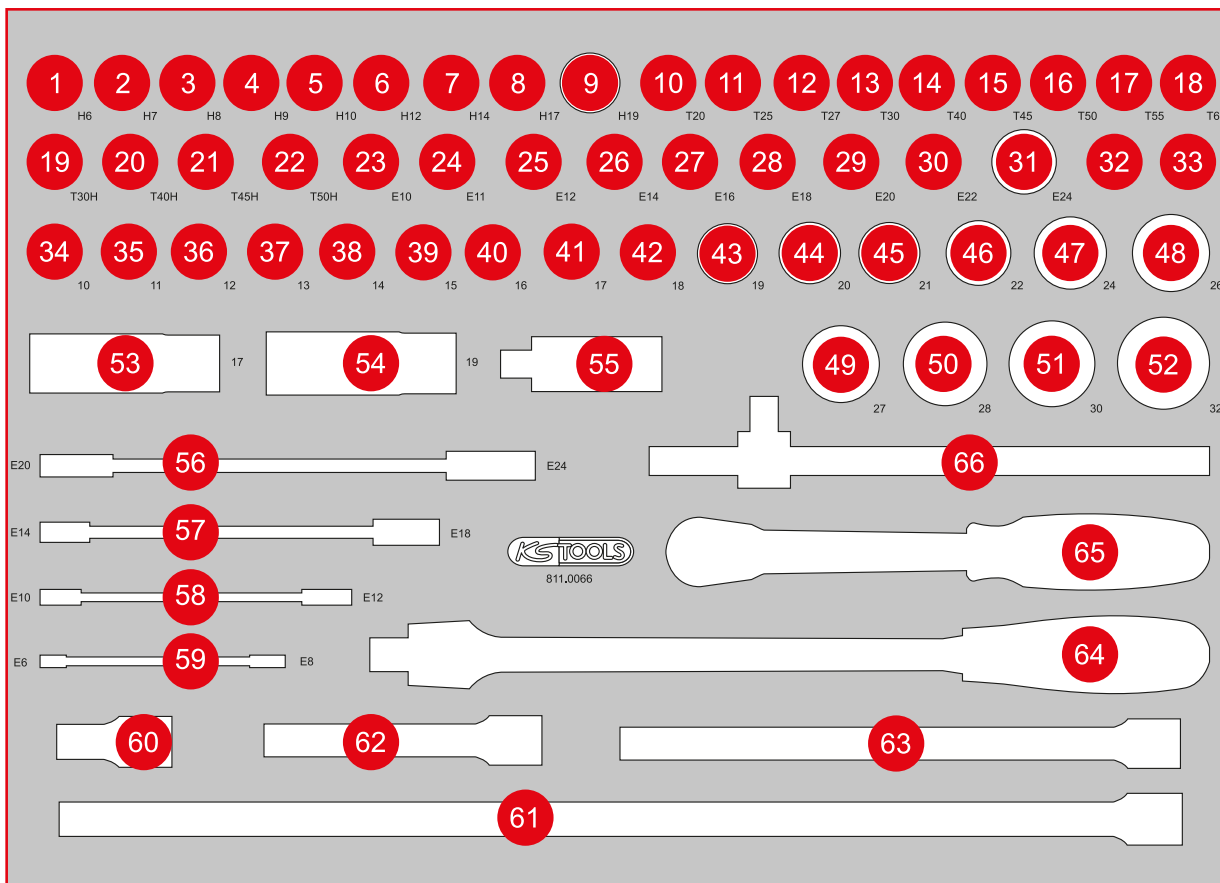

Pos.	Code	Description	pcs	Pos.	Code	Description	pcs	Pos.	Code	Description	pcs
34	917.1210	1/2" Hexagonal socket, 10 mm	1	45	917.1221	1/2" Hexagonal socket, 21 mm	1	56	911.0376	Double ring spanner for Torx E profile, E20 x E24	1
35	917.1211	1/2" Hexagonal socket, 11 mm	1	46	917.1222	1/2" Hexagonal socket, 22 mm	1	57	911.0374	Double ring spanner for Torx E profile, E14 x E18	1
36	917.1212	1/2" Hexagonal socket, 12 mm	1	47	917.1224	1/2" Hexagonal socket, 24 mm	1	58	911.0373	Double ring spanner for Torx E profile, E10 x E12	1
37	917.1213	1/2" Hexagonal socket, 13 mm	1	48	917.1343	1/2" Hexagonal socket, 26 mm	1	59	911.0371	Double ring spanner for Torx E profile, E6 x E8	1
38	917.1214	1/2" Hexagonal socket, 14 mm	1	49	917.1227	1/2" Hexagonal socket, 27 mm	1	60	911.1381	Wobble extension, 1/2", 50 mm	1
39	917.1215	1/2" Hexagonal socket, 15 mm	1	50	917.1344	1/2" Hexagonal socket, 28 mm	1	61	911.1386	Wobble extension, 1/2", 500 mm	1
40	917.1216	1/2" Hexagonal socket, 16 mm	1	51	917.1230	1/2" Hexagonal socket, 30 mm	1	62	911.1202	1/2" Extensions, 125 mm	1
41	917.1217	1/2" Hexagonal socket, 17 mm	1	52	917.1232	1/2" Hexagonal socket, 32 mm	1	63	911.1203	1/2" Extensions, 250 mm	1
42	917.1218	1/2" Hexagonal socket, 18 mm	1	53	515.0992	SlimPOWER 1/2" Alloy rim impact socket, 17mm	1	64	917.1455	1/2" Flexi head drive handle	1
43	917.1219	1/2" Hexagonal socket, 19 mm	1	54	515.0993	SlimPOWER 1/2" Alloy rim impact socket, 19 mm	1	65	920.1290	1/2" SlimPOWER Reversible ratchet, 72 teeth	1
44	917.1220	1/2" Hexagonal socket, 20 mm	1	55	911.1250	1/2" Universal joint	1	66	911.1204	Sliding T-bar, 1/2", 250 mm	1

P 10
P 15
P 20
P 25
P 30
P 35
P 40
P 45
S
XL
L
M
Individual parts
Accessories

M 1/2" Socket spanner set



369,^{EUR}—

95

568 x 398

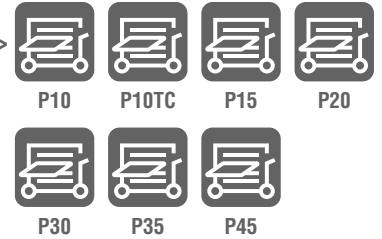

Pos.	Code	Description	pcs	Pos.	Code	Description	pcs	Pos.	Code	Description	pcs
1	911.1306	1/2" Bit socket hexagon, short, 6 mm	1	17	911.4514	Bit socket for RIBE screws, M8, length 55 mm	1	32	911.1370	1/2" Bit socket Torx, T70	1
2	911.1307	1/2" Bit socket hexagon, short, 7 mm	1	18	911.4515	Bit socket for RIBE screws, M9, length 55 mm	1	33	911.1340	1/2" Bit socket spline (XZN), M5, 55 mm	1
3	911.1308	1/2" Bit socket hexagon, short, 8 mm	1	19	911.4516	Bit socket for RIBE screws, M10, length 55 mm	1	34	911.1341	1/2" Bit socket spline (XZN), M6, 55 mm	1
4	911.1309	1/2" Bit socket hexagon, short, 9 mm	1	20	911.4551	Bit socket for RIBE screws, M10.1, length 55 mm	1	35	911.1342	1/2" Bit socket spline (XZN), M8, 55 mm	1
5	911.1310	1/2" Bit socket hexagon, short, 10 mm	1	21	911.4517	Bit socket for RIBE screws, M12, length 55 mm	1	36	911.1313	1/2" Bit socket spline (XZN), M9, 55 mm	1
6	911.1312	1/2" Bit socket hexagon, short, 12 mm	1	22	911.4518	Bit socket for RIBE screws, M13, length 55 mm	1	37	911.1343	1/2" Bit socket spline (XZN), M10, 55 mm	1
7	911.1314	1/2" Bit socket hexagon, short, 14 mm	1	23	911.4519	Bit socket for RIBE screws, M14, length 55 mm	1	38	911.1344	1/2" Bit socket spline (XZN), M12, 55 mm	1
8	911.1317	1/2" Bit socket hexagon, short, 17 mm	1	24	911.1348	1/2" Bit socket spline (XZN) tamperproof, M16, 55 mm	1	39	911.1345	1/2" Bit socket spline (XZN), M14, 55 mm	1
9	911.1373	1/2" Bit socket Torx tamperproof, TB27	1	25	911.1363	1/2" Bit socket Torx, T27	1	40	911.1346	1/2" Bit socket spline (XZN), M16, 55 mm	1
10	911.1374	1/2" Bit socket Torx tamperproof, TB30	1	26	911.1364	1/2" Bit socket Torx, T30	1	41	911.5306	1/2" Bit socket spline (XZN), M17, 55 mm	1
11	911.1375	1/2" Bit socket Torx tamperproof, TB40	1	27	911.1365	1/2" Bit socket Torx, T40	1	42	911.4335	1/2" Torx E Socket, E12	1
12	911.1376	1/2" Bit socket Torx tamperproof, TB45	1	28	911.1366	1/2" Bit socket Torx, T45	1	43	911.4336	1/2" Torx E Socket, E14	1
13	911.1377	1/2" Bit socket Torx tamperproof, TB50	1	29	911.1367	1/2" Bit socket Torx, T50	1	44	911.4322	1/2" Torx E Socket, E16	1
14	911.1378	1/2" Bit socket Torx tamperproof, TB55	1	30	911.1368	1/2" Bit socket Torx, T55	1	45	911.4323	1/2" Torx E Socket, E18	1
15	911.1379	1/2" Bit socket Torx tamperproof, TB60	1	31	911.1369	1/2" Bit socket Torx, T60	1	46	911.4324	1/2" Torx E Socket, E20	1
16	911.1380	1/2" Bit socket Torx tamperproof, TB70	1					47	911.4325	1/2" Torx E Socket, E22	1

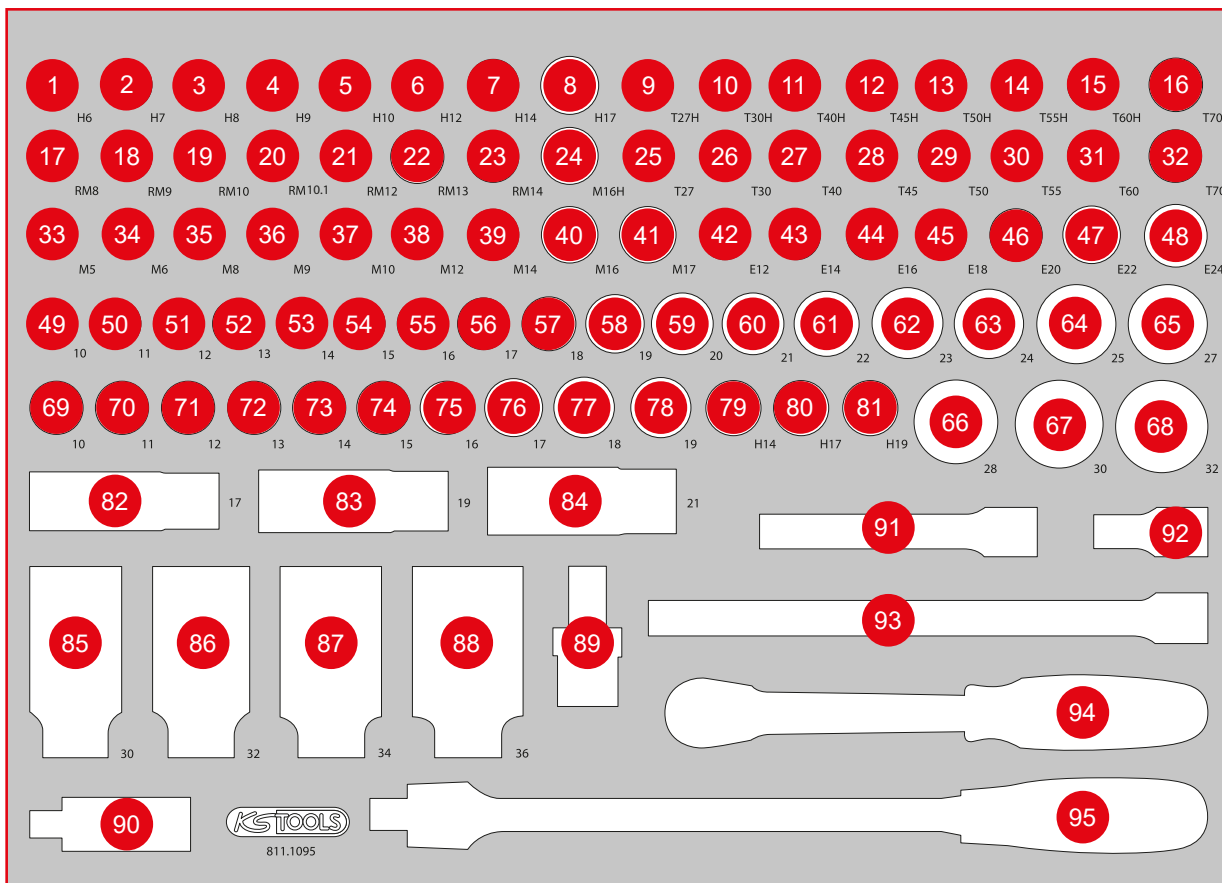

Pos.	Code	Description	pcs	Pos.	Code	Description	pcs	Pos.	Code	Description	pcs
48	911.4326	1/2" Torx E Socket, E24	1	64	917.1343	1/2" Hexagonal socket, 26 mm	1	80	911.0909	1/2" Impact bit socket, hexagon, short, 17 mm	1
49	917.1210	1/2" Hexagonal socket, 10 mm	1	65	917.1227	1/2" Hexagonal socket, 27 mm	1	81	911.0911	1/2" Impact bit socket, hexagon, short, 19 mm	1
50	917.1211	1/2" Hexagonal socket, 11 mm	1	66	917.1344	1/2" Hexagonal socket, 28 mm	1	82	515.0992	SlimPOWER 1/2" Alloy rim impact socket, 17mm	1
51	917.1212	1/2" Hexagonal socket, 12 mm	1	67	917.1230	1/2" Hexagonal socket, 30 mm	1	83	515.0993	SlimPOWER 1/2" Alloy rim impact socket, 19 mm	1
52	917.1213	1/2" Hexagonal socket, 13 mm	1	68	917.1232	1/2" Hexagonal socket, 32 mm	1	84	515.0994	SlimPOWER 1/2" Alloy rim impact socket, 21 mm	1
53	917.1214	1/2" Hexagonal socket, 14 mm	1	69	515.1010	1/2" Hexagon impact socket short, 10 mm	1	85	150.1705	Special drive shaft impact socket, 1/2", 30 mm	1
54	917.1215	1/2" Hexagonal socket, 15 mm	1	70	515.1011	1/2" Hexagon impact socket short, 11 mm	1	86	150.1706	Special drive shaft impact socket, 1/2", 32 mm	1
55	917.1216	1/2" Hexagonal socket, 16 mm	1	71	515.1012	1/2" Hexagon impact socket short, 12 mm	1	87	150.1704	Special drive shaft impact socket, 1/2", 34 mm	1
56	917.1217	1/2" Hexagonal socket, 17 mm	1	72	515.1013	1/2" Hexagon impact socket short, 13 mm	1	88	150.1707	Special drive shaft impact socket, 1/2", 36 mm	1
57	917.1218	1/2" Hexagonal socket, 18 mm	1	73	515.1014	1/2" Hexagon impact socket short, 14 mm	1	89	515.1133	1/2" Impact universal ball joint	1
58	917.1219	1/2" Hexagonal socket, 19 mm	1	74	515.1015	1/2" Hexagon impact socket short, 15 mm	1	90	911.1250	1/2" Universal joint	1
59	917.1220	1/2" Hexagonal socket, 20 mm	1	75	515.1016	1/2" Hexagon impact socket short, 16 mm	1	91	911.1202	1/2" Extensions, 125 mm	1
60	917.1221	1/2" Hexagonal socket, 21 mm	1	76	515.1017	1/2" Hexagon impact socket short, 17 mm	1	92	911.1381	Wobble extension, 1/2", 50 mm	1
61	917.1222	1/2" Hexagonal socket, 22 mm	1	77	515.1018	1/2" Hexagon impact socket short, 18 mm	1	93	911.1203	1/2" Extensions, 250 mm	1
62	917.1223	1/2" Hexagonal socket, 23 mm	1	78	515.1019	1/2" Hexagon impact socket short, 19 mm	1	94	920.1290	1/2" SlimPOWER Reversible ratchet, 72 teeth	1
63	917.1224	1/2" Hexagonal socket, 24 mm	1	79	911.0908	1/2" Impact bit socket, hexagon, short, 14 mm	1	95	917.1455	1/2" Flexi head drive handle	1

P 10
P 15
P 20
P 25
P 30
P 35
P 40
P 45
Individual parts S XL L M
Accessories

811.0095

M 1/2" Socket spanner set

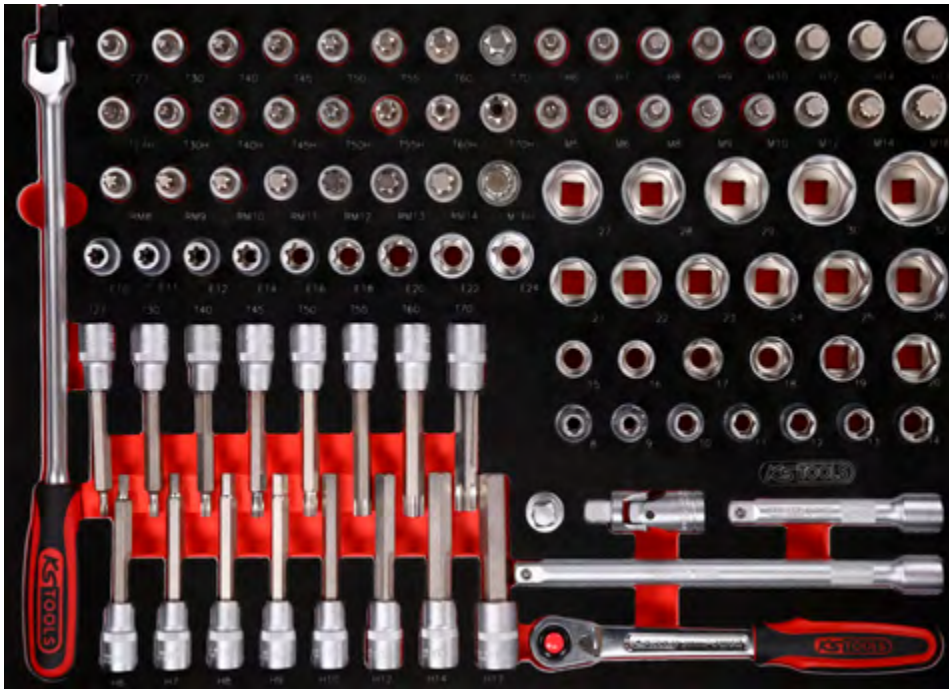

309, — ^{EUR}

95

568 x 398

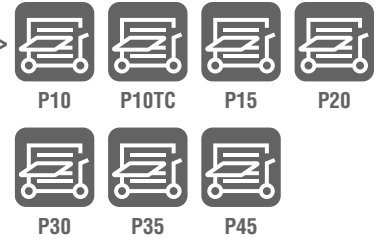

Pos.	Code	Description	pcs	Pos.	Code	Description	pcs	Pos.	Code	Description	pcs
1	917.1455	1/2" Flexi head drive handle	1	18	911.1373	1/2" Bit socket Torx tamperproof, TB27	1	35	911.4515	Bit socket for RIBE screws, M9, length 55 mm	1
2	911.1363	1/2" Bit socket Torx, T27	1	19	911.1374	1/2" Bit socket Torx tamperproof, TB30	1	36	911.4516	Bit socket for RIBE screws, M10, length 55 mm	1
3	911.1364	1/2" Bit socket Torx, T30	1	20	911.1375	1/2" Bit socket Torx tamperproof, TB40	1	37	911.4551	Bit socket for RIBE screws, M10.1, length 55 mm	1
4	911.1365	1/2" Bit socket Torx, T40	1	21	911.1376	1/2" Bit socket Torx tamperproof, TB45	1	38	911.4517	Bit socket for RIBE screws, M12, length 55 mm	1
5	911.1366	1/2" Bit socket Torx, T45	1	22	911.1377	1/2" Bit socket Torx tamperproof, TB50	1	39	911.4518	Bit socket for RIBE screws, M13, length 55 mm	1
6	911.1367	1/2" Bit socket Torx, T50	1	23	911.1378	1/2" Bit socket Torx tamperproof, TB55	1	40	911.4519	Bit socket for RIBE screws, M14, length 55 mm	1
7	911.1368	1/2" Bit socket Torx, T55	1	24	911.1379	1/2" Bit socket Torx tamperproof, TB60	1	41	911.1348	1/2" Bit socket spline (XZN) tamperproof, M16, 55 mm	1
8	911.1369	1/2" Bit socket Torx, T60	1	25	911.1380	1/2" Bit socket Torx tamperproof, TB70	1	42	917.1227	1/2" Hexagonal socket, 27 mm	1
9	911.1370	1/2" Bit socket Torx, T70	1	26	911.1340	1/2" Bit socket spline (XZN), M5, 55 mm	1	43	917.1344	1/2" Hexagonal socket, 28 mm	1
10	911.1306	1/2" Bit socket hexagon, short, 6 mm	1	27	911.1341	1/2" Bit socket spline (XZN), M6, 55 mm	1	44	917.1345	1/2" Hexagonal socket, 29 mm	1
11	911.1307	1/2" Bit socket hexagon, short, 7 mm	1	28	911.1342	1/2" Bit socket spline (XZN), M8, 55 mm	1	45	917.1230	1/2" Hexagonal socket, 30 mm	1
12	911.1308	1/2" Bit socket hexagon, short, 8 mm	1	29	911.1313	1/2" Bit socket spline (XZN), M9, 55 mm	1	46	917.1232	1/2" Hexagonal socket, 32 mm	1
13	911.1309	1/2" Bit socket hexagon, short, 9 mm	1	30	911.1343	1/2" Bit socket spline (XZN), M10, 55 mm	1	47	911.4333	1/2" Torx E Socket, E10	1
14	911.1310	1/2" Bit socket hexagon, short, 10 mm	1	31	911.1344	1/2" Bit socket spline (XZN), M12, 55 mm	1	48	911.4334	1/2" Torx E Socket, E11	1
15	911.1312	1/2" Bit socket hexagon, short, 12 mm	1	32	911.1345	1/2" Bit socket spline (XZN), M14, 55 mm	1	49	911.4335	1/2" Torx E Socket, E12	1
16	911.1314	1/2" Bit socket hexagon, short, 14 mm	1	33	911.1346	1/2" Bit socket spline (XZN), M16, 55 mm	1	50	911.4336	1/2" Torx E Socket, E14	1
17	911.1317	1/2" Bit socket hexagon, short, 17 mm	1	34	911.4514	Bit socket for RIBE screws, M8, length 55 mm	1				

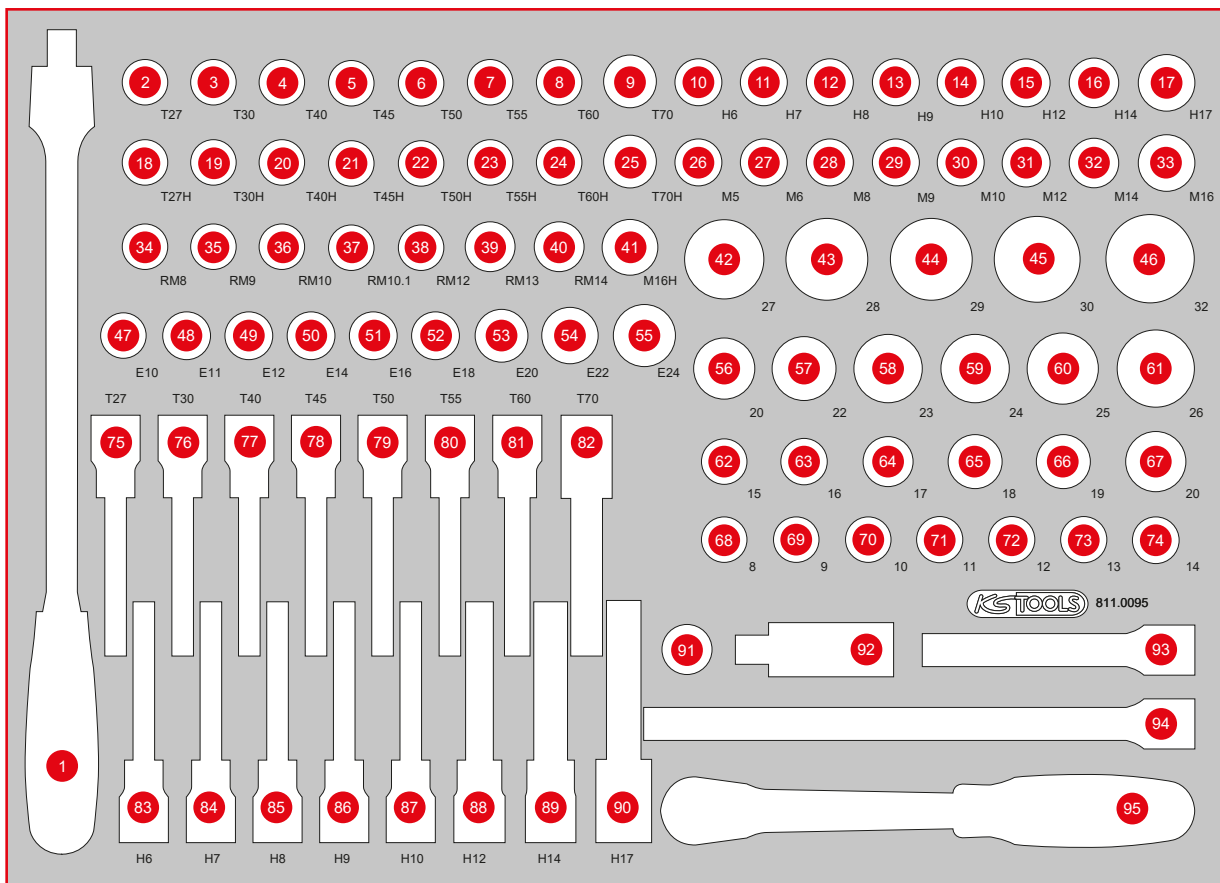

Pos.	Code	Description	pcs	Pos.	Code	Description	pcs	Pos.	Code	Description	pcs
51	911.4322	1/2" Torx E Socket, E16	1	68	917.1340	1/2" Hexagonal socket, 8 mm	1	77	911.1525	1/2" Bit socket Torx, long, T40	1
52	911.4323	1/2" Torx E Socket, E18	1	69	917.1341	1/2" Hexagonal socket, 9 mm	1	78	911.1526	1/2" Bit socket Torx, long, T45	1
53	911.4324	1/2" Torx E Socket, E20	1	70	917.1210	1/2" Hexagonal socket, 10 mm	1	79	911.1527	1/2" Bit socket Torx, long, T50	1
54	911.4325	1/2" Torx E Socket, E22	1	71	917.1211	1/2" Hexagonal socket, 11 mm	1	80	911.1528	1/2" Bit socket Torx, long, T55	1
55	911.4326	1/2" Torx E Socket, E24	1	72	917.1212	1/2" Hexagonal socket, 12 mm	1	81	911.1529	1/2" Bit socket Torx, long, T60	1
56	917.1221	1/2" Hexagonal socket, 21 mm	1	73	917.1213	1/2" Hexagonal socket, 13 mm	1	82	911.1517	1/2" Bit socket Torx, long, T70	1
57	917.1222	1/2" Hexagonal socket, 22 mm	1	74	917.1214	1/2" Hexagonal socket, 14 mm	1	91	911.1207	3/8" Sliding adaptor, 3/8" F x 1/2" M	1
58	917.1223	1/2" Hexagonal socket, 23 mm	1	83	911.1326	1/2" Bit socket hexagon, long, 6 mm	1	92	911.1250	1/2" Universal joint	1
59	917.1224	1/2" Hexagonal socket, 24 mm	1	84	911.1327	1/2" Bit socket hexagon, long, 7 mm	1	93	911.1202	1/2" Extensions, 125 mm	1
60	917.1342	1/2" Hexagonal socket, 25 mm	1	85	911.1328	1/2" Bit socket hexagon, long, 8 mm	1	94	911.1203	1/2" Extensions, 250 mm	1
61	917.1343	1/2" Hexagonal socket, 26 mm	1	86	911.1329	1/2" Bit socket hexagon, long, 9 mm	1	95	920.1290	1/2" SlimPOWER Reversible ratchet, 72 teeth	1
62	917.1215	1/2" Hexagonal socket, 15 mm	1	87	911.1330	1/2" Bit socket hexagon, long, 10 mm	1				
63	917.1216	1/2" Hexagonal socket, 16 mm	1	88	911.1332	1/2" Bit socket hexagon, long, 12 mm	1				
64	917.1217	1/2" Hexagonal socket, 17 mm	1	89	917.1332	1/2" Bit socket hexagon, long, 14 mm	1				
65	917.1218	1/2" Hexagonal socket, 18 mm	1	90	911.1337	1/2" Bit socket hexagon, long, 17 mm	1				
66	917.1219	1/2" Hexagonal socket, 19 mm	1	75	911.1523	1/2" Bit socket Torx, long, T27	1				
67	917.1220	1/2" Hexagonal socket, 20 mm	1	76	911.1524	1/2" Bit socket Torx, long, T30	1				

P 10
P 15
P 20
P 25
P 30
P 35
P 40
P 45
Individual parts S XL L M
Accessories

811.0063

M 1/2" Socket spanner and screwdriver bit set



229, ^{EUR}-

IPCS
63

568 x 398

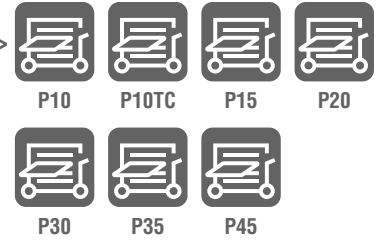

Pos.	Code	Description	pcs	Pos.	Code	Description	pcs	Pos.	Code	Description	pcs
1	917.1240	1/2" Hexagonal socket, deep, 10 mm	1	12	917.1259	1/2" Hexagonal socket, deep, 21 mm	1	23	911.4431	1/2" Torx E Socket, deep, E24	1
2	917.1241	1/2" Hexagonal socket, deep, 11 mm	1	13	917.1252	1/2" Hexagonal socket, deep, 22 mm	1	24	917.1337	1/2" Hexagonal socket, deep, 26 mm	1
3	917.1242	1/2" Hexagonal socket, deep, 12 mm	1	14	917.1315	1/2" Hexagonal socket, deep, 23 mm	1	25	917.1254	1/2" Hexagonal socket, deep, 27 mm	1
4	917.1243	1/2" Hexagonal socket, deep, 13 mm	1	15	917.1257	1/2" Hexagonal socket, deep, 24 mm	1	26	917.1338	1/2" Hexagonal socket, deep, 28 mm	1
5	917.1244	1/2" Hexagonal socket, deep, 14 mm	1	16	911.4423	1/2" Torx E Socket, 78 mm long, E10	1	27	917.1255	1/2" Hexagonal socket, deep, 30 mm	1
6	917.1245	1/2" Hexagonal socket, deep, 15 mm	1	17	911.4424	1/2" Torx E Socket, deep, E11	1	28	917.1256	1/2" Hexagonal socket, deep, 32 mm	1
7	917.1246	1/2" Hexagonal socket, deep, 16 mm	1	18	911.4425	1/2" Torx E Socket, 78 mm, E12	1	29	917.1296	1/2" Bit socket Torx tamperproof, long, TB30	1
8	917.1247	1/2" Hexagonal socket, deep, 17 mm	1	19	911.4426	1/2" Torx E Socket, 78 mm, E14	1	30	917.1297	1/2" Bit socket Torx tamperproof, long, TB40	1
9	917.1248	1/2" Hexagonal socket, deep, 18 mm	1	20	911.4427	1/2" Torx E Socket, 78 mm, E16	1	31	917.1298	1/2" Bit socket Torx tamperproof, long, TB45	1
10	917.1249	1/2" Hexagonal socket, deep, 19 mm	1	21	911.4428	1/2" Torx E Socket, 78 mm, E18	1	32	917.1299	1/2" Bit socket Torx tamperproof, long, TB50	1
11	917.1258	1/2" Hexagonal socket, deep, 20 mm	1	22	911.4429	1/2" Torx E Socket, 78 mm, E20	1	33	917.1251	1/2" Bit socket Torx tamperproof, long, TB55	1

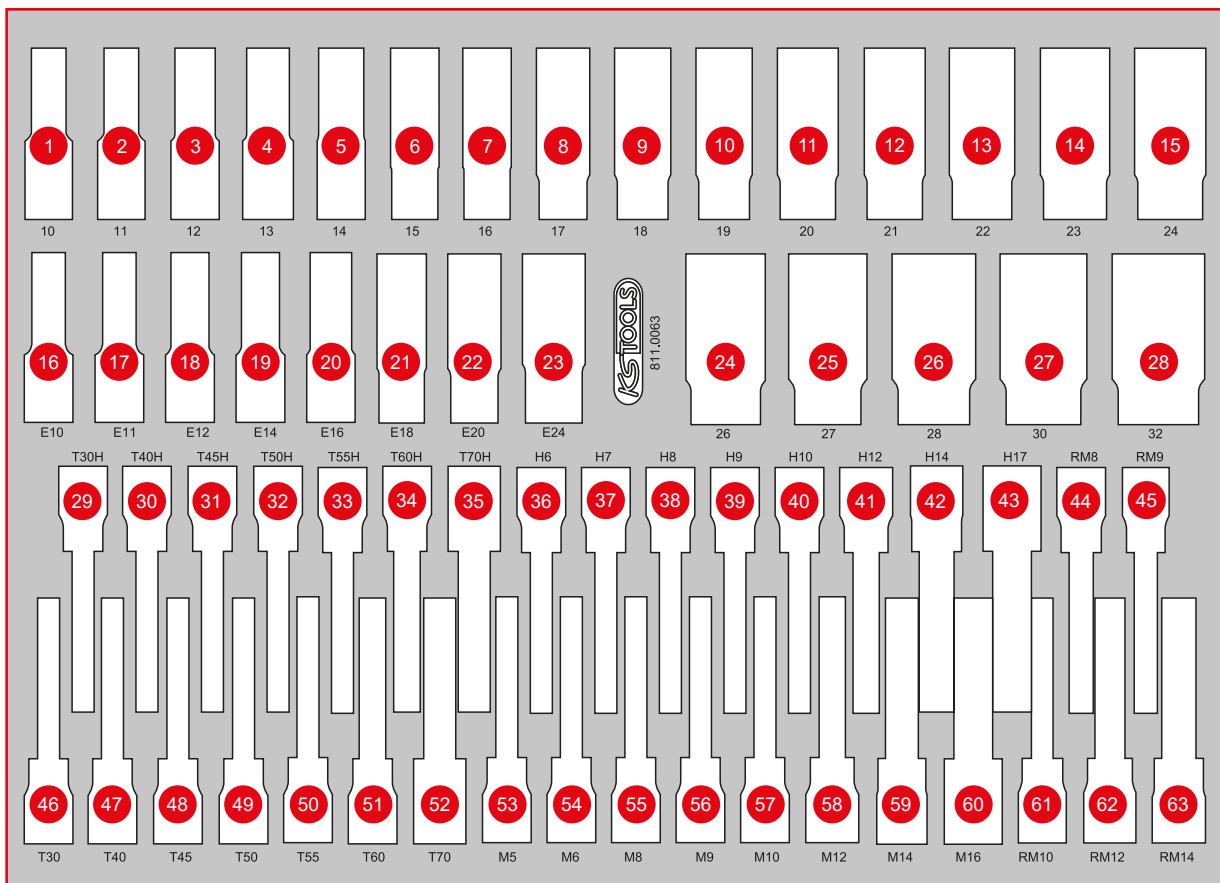

Pos.	Code	Description	pcs	Pos.	Code	Description	pcs	Pos.	Code	Description	pcs
34	917.1253	1/2" Bit socket Torx tamperproof, long, TB60	1	45	911.1925	1/2" Bit socket RIBE, M9, 110 mm	1	56	911.1359	1/2" Bit socket spline (XZN), M9, 110 mm	1
35	917.1304	1/2" Bit socket Torx tamperproof, long, TB70	1	46	911.1524	1/2" Bit socket Torx, long, T30	1	57	911.1353	1/2" Bit socket spline (XZN), M10, 110 mm	1
36	911.1326	1/2" Bit socket hexagon, long, 6 mm	1	47	911.1525	1/2" Bit socket Torx, long, T40	1	58	911.1354	1/2" Bit socket spline (XZN), M12, 110 mm	1
37	911.1327	1/2" Bit socket hexagon, long, 7 mm	1	48	911.1526	1/2" Bit socket Torx, long, T45	1	59	911.1355	1/2" Bit socket spline (XZN), M14, 110 mm	1
38	911.1328	1/2" Bit socket hexagon, long, 8 mm	1	49	911.1527	1/2" Bit socket Torx, long, T50	1	60	911.1356	1/2" Bit socket spline (XZN), M16, 110 mm	1
39	911.1329	1/2" Bit socket hexagon, long, 9 mm	1	50	911.1528	1/2" Bit socket Torx, long, T55	1	61	911.1926	1/2" Bit socket RIBE, M10, 110 mm	1
40	911.1330	1/2" Bit socket hexagon, long, 10 mm	1	51	911.1529	1/2" Bit socket Torx, long, T60	1	62	911.1995	1/2" Bit socket RIBE, M12, 110 mm	1
41	911.1332	1/2" Bit socket hexagon, long, 12 mm	1	52	911.1517	1/2" Bit socket Torx, long, T70	1	63	911.1997	1/2" Bit socket RIBE, M14, 110 mm	1
42	917.1332	1/2" Bit socket hexagon, long, 14 mm	1	53	911.1350	1/2" Bit socket spline (XZN), M5, 110 mm	1				
43	911.1337	1/2" Bit socket hexagon, long, 17 mm	1	54	911.1351	1/2" Bit socket spline (XZN), M6, 110 mm	1				
44	911.1924	1/2" Bit socket RIBE, M8, 110 mm	1	55	911.1352	1/2" Bit socket spline (XZN), M8, 110 mm	1				

P 10
P 15
P 20
P 25
P 30
P 35
P 40
P 45
Individual parts S XL L M
Accessories

811.0064

M 1/2" Screwdriver bit set



249,^{EUR}-

64 PCS

568 x 398

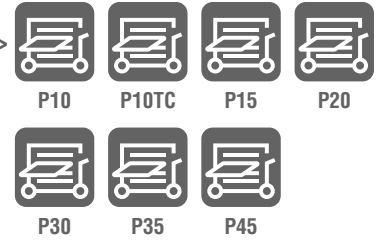

Pos.	Code	Description	pcs	Pos.	Code	Description	pcs	Pos.	Code	Description	pcs
1	920.1290	1/2" SlimPOWER Reversible ratchet, 72 teeth	1	12	515.0991	SlimPOWER 1/2"Alloy rim impact socket, 15 mm	1	23	911.1656	Hex bit socket, ball ended, long, 1/2", 6 mm	1
2	911.1204	Sliding T-bar, 1/2", 250 mm	1	13	515.0992	SlimPOWER 1/2"Alloy rim impact socket, 17mm	1	24	911.1657	Hex bit socket, ball ended, long, 1/2", 7 mm	1
3	911.1383	Wobble extension, 1/2", 125 mm	1	14	515.0993	SlimPOWER 1/2"Alloy rim impact socket, 19 mm	1	25	911.1658	Hex bit socket, ball ended, long, 1/2", 8 mm	1
4	911.1202	1/2" Extensions, 125 mm	1	15	515.0994	SlimPOWER 1/2"Alloy rim impact socket, 21 mm	1	26	911.1659	Hex bit socket, ball ended, long, 1/2", 9 mm	1
5	911.1203	1/2" Extensions, 250 mm	1	16	515.0995	SlimPOWER 1/2"Alloy rim impact socket, 22 mm	1	27	911.1660	Hex bit socket, ball ended, long, 1/2", 10 mm	1
6	911.1384	Wobble extension, 1/2", 250 mm	1	17	911.1352	1/2" Bit socket spline (XZN), M8, 110 mm	1	28	911.1526	1/2" Bit socket Torx, long, T45	1
7	911.1381	Wobble extension, 1/2", 50 mm	1	18	911.1359	1/2" Bit socket spline (XZN), M9, 110 mm	1	29	911.1326	1/2" Bit socket hexagon, long, 6 mm	1
8	911.1250	1/2" Universal joint	1	19	911.1353	1/2" Bit socket spline (XZN), M10, 110 mm	1	30	911.1328	1/2" Bit socket hexagon, long, 8 mm	1
9	911.1234	Adaptor, 1/2"F x 3/4"M	1	20	911.1354	1/2" Bit socket spline (XZN), M12, 110 mm	1	31	911.5313	Hex bit socket, ball ended, long, 1/2", 6 mm	1
10	150.1701	3/4" Impact bit socket for spline(XZN®) screws	1	21	911.1355	1/2" Bit socket spline (XZN), M14, 110 mm	1	32	911.1960	1/2" Bit socket hexagon, 10 mm, 140 mm	1
11	911.3545	3/4" 12 Point socket, short, 34 mm	1	22	911.1655	Hex bit socket, ball ended, long, 1/2", 5 mm	1	33	911.1366	1/2" Bit socket Torx, T45	1

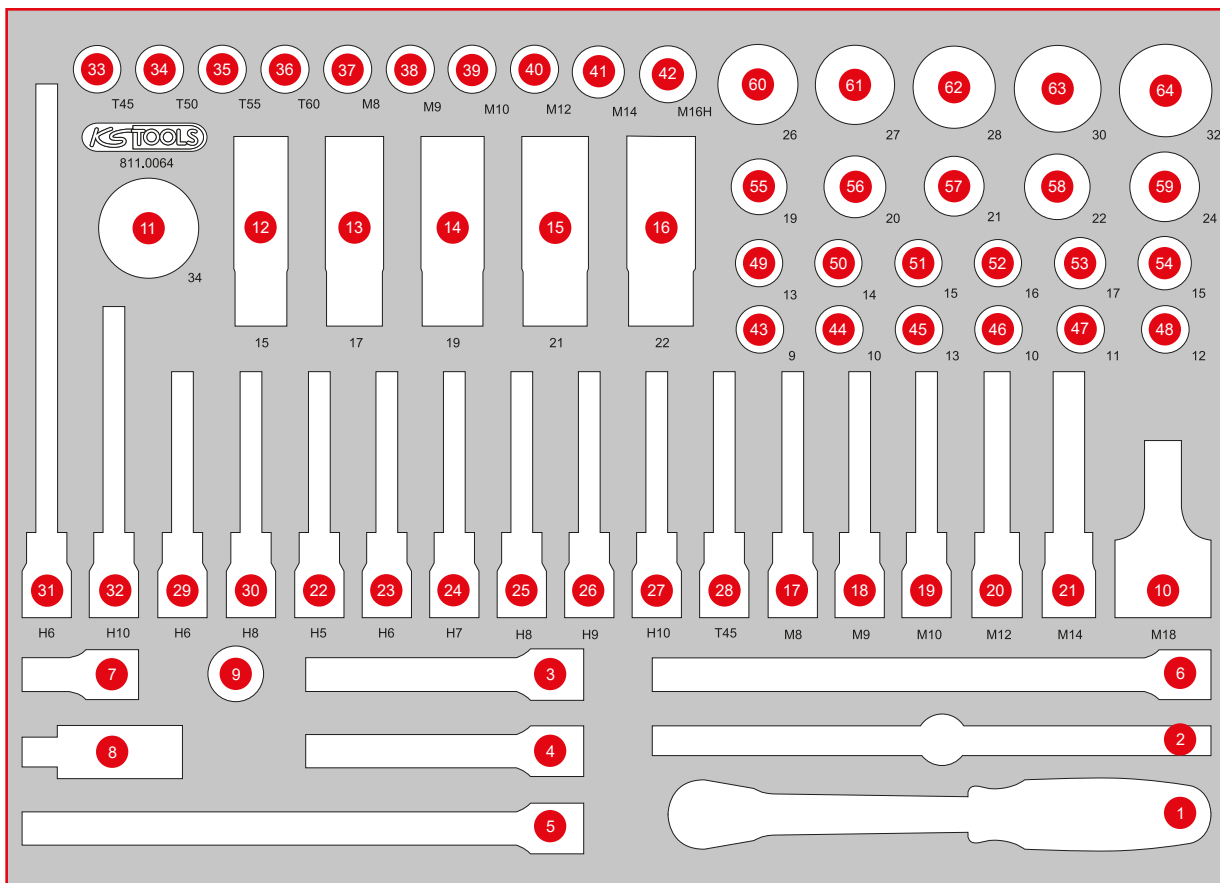

Pos.	Code	Description	pcs	Pos.	Code	Description	pcs	Pos.	Code	Description	pcs
34	911.1367	1/2" Bit socket Torx, T50	1	44	911.1570	1/2" 12 Point socket, 10 mm	1	55	917.1219	1/2" Hexagonal socket, 19 mm	1
35	911.1368	1/2" Bit socket Torx, T55	1	45	911.1573	1/2" 12 Point socket, 13 mm	1	56	917.1220	1/2" Hexagonal socket, 20 mm	1
36	911.1369	1/2" Bit socket Torx, T60	1	46	917.1210	1/2" Hexagonal socket, 10 mm	1	57	917.1221	1/2" Hexagonal socket, 21 mm	1
37	911.1342	1/2" Bit socket spline (XZN), M8, 55 mm	1	47	917.1211	1/2" Hexagonal socket, 11 mm	1	58	917.1222	1/2" Hexagonal socket, 22 mm	1
38	911.1313	1/2" Bit socket spline (XZN), M9, 55 mm	1	48	917.1212	1/2" Hexagonal socket, 12 mm	1	59	917.1224	1/2" Hexagonal socket, 24 mm	1
39	911.1343	1/2" Bit socket spline (XZN), M10, 55 mm	1	49	917.1213	1/2" Hexagonal socket, 13 mm	1	60	917.1343	1/2" Hexagonal socket, 26 mm	1
40	911.1344	1/2" Bit socket spline (XZN), M12, 55 mm	1	50	917.1214	1/2" Hexagonal socket, 14 mm	1	61	917.1227	1/2" Hexagonal socket, 27 mm	1
41	911.1345	1/2" Bit socket spline (XZN), M14, 55 mm	1	51	917.1215	1/2" Hexagonal socket, 15 mm	1	62	917.1344	1/2" Hexagonal socket, 28 mm	1
42	911.1348	1/2" Bit socket spline (XZN) tamperproof, M16, 55 mm	1	52	917.1216	1/2" Hexagonal socket, 16 mm	1	63	917.1230	1/2" Hexagonal socket, 30 mm	1
43	917.1361	1/2" 12 Point socket, 8 mm	1	53	917.1217	1/2" Hexagonal socket, 17 mm	1	64	917.1232	1/2" Hexagonal socket, 32 mm	1
				54	917.1218	1/2" Hexagonal socket, 18 mm	1				

P 10
P 15
P 20
P 25
P 30
P 35
P 40
P 45
Accessories Individual parts S XL L M

811.1064

M 1/2" Screwdriver bit set



259, ^{EUR}-

1PCS
64

568 x 398

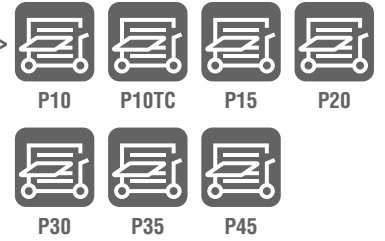

Pos.	Code	Description	pcs	Pos.	Code	Description	pcs	Pos.	Code	Description	pcs
1	911.1325	1/2" Bit socket hexagon, long, 5 mm	1	12	911.1697	Hex bit socket, ball ended, long, 1/2", 14mm	1	23	911.1524	1/2" Bit socket Torx, long, T30	1
2	911.1326	1/2" Bit socket hexagon, long, 6 mm	1	13	911.1696	Hex bit socket, ball ended, long, 1/2", 13 mm	1	24	911.1525	1/2" Bit socket Torx, long, T40	1
3	911.1327	1/2" Bit socket hexagon, long, 7 mm	1	14	911.1662	Hex bit socket, ball ended, long, 1/2", 12 mm	1	25	911.1526	1/2" Bit socket Torx, long, T45	1
4	911.1328	1/2" Bit socket hexagon, long, 8 mm	1	15	911.1695	Hex bit socket, ball ended, long, 1/2", 11 mm	1	26	911.1527	1/2" Bit socket Torx, long, T50	1
5	911.1329	1/2" Bit socket hexagon, long, 9 mm	1	16	911.1660	Hex bit socket, ball ended, long, 1/2", 10 mm	1	27	911.1528	1/2" Bit socket Torx, long, T55	1
6	911.1330	1/2" Bit socket hexagon, long, 10 mm	1	17	911.1659	Hex bit socket, ball ended, long, 1/2", 9 mm	1	28	911.1529	1/2" Bit socket Torx, long, T60	1
7	911.5353	1/2" Bit socket hexagon, long, 11 mm	1	18	911.1658	Hex bit socket, ball ended, long, 1/2", 8 mm	1	29	911.1517	1/2" Bit socket Torx, long, T70	1
8	911.1332	1/2" Bit socket hexagon, long, 12 mm	1	19	911.1657	Hex bit socket, ball ended, long, 1/2", 7 mm	1	30	911.5308	1/2" Bit socket Torx, long, T80	1
9	911.5354	1/2" Bit socket hexagon, long, 13 mm	1	20	911.1656	Hex bit socket, ball ended, long, 1/2", 6 mm	1	31	911.5389	TX bit socket deep, 1/2", T90	1
10	917.1332	1/2" Bit socket hexagon, long, 14 mm	1	21	911.1655	Hex bit socket, ball ended, long, 1/2", 5 mm	1	32	911.5388	1/2" Bit socket Torx, long, T100	1
11	911.1337	1/2" Bit socket hexagon, long, 17 mm	1	22	911.1523	1/2" Bit socket Torx, long, T27	1	33	911.1632	1/2" Bit socket Torx tamperproof, long, TB80	1

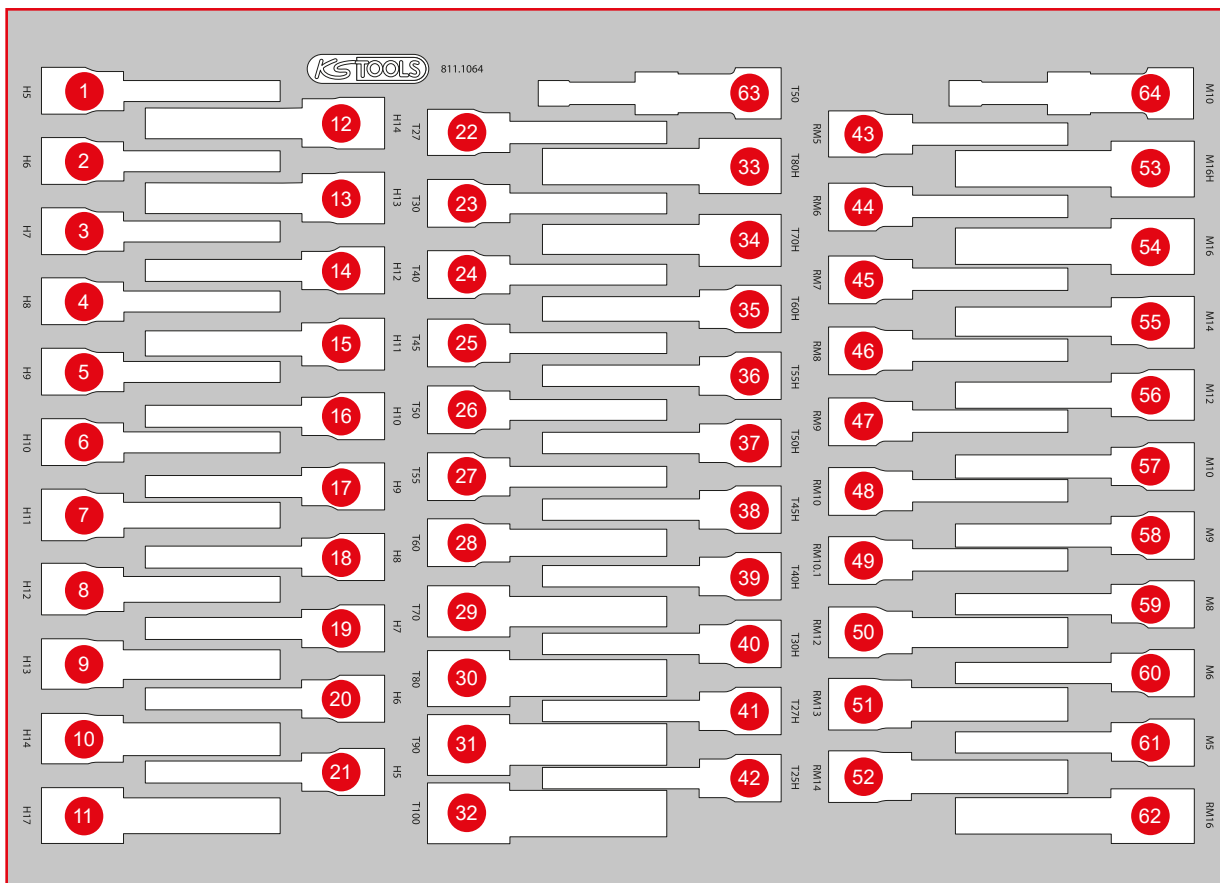

Pos.	Code	Description	pcs	Pos.	Code	Description	pcs	Pos.	Code	Description	pcs
34	917.1304	1/2" Bit socket Torx tamperproof, long, TB70	1	45	911.1923	1/2" Bit socket RIBE, M7, 110 mm	1	56	911.1354	1/2" Bit socket spline (XZN), M12, 110 mm	1
35	917.1253	1/2" Bit socket Torx tamperproof, long, TB60	1	46	911.1924	1/2" Bit socket RIBE, M8, 110 mm	1	57	911.1353	1/2" Bit socket spline (XZN), M10, 110 mm	1
36	917.1251	1/2" Bit socket Torx tamperproof, long, TB55	1	47	911.1925	1/2" Bit socket RIBE, M9, 110mm	1	58	911.1359	1/2" Bit socket spline (XZN), M9, 110 mm	1
37	917.1299	1/2" Bit socket Torx tamperproof, long, TB50	1	48	911.1926	1/2" Bit socket RIBE, M10, 110 mm	1	59	911.1352	1/2" Bit socket spline (XZN), M8, 110 mm	1
38	917.1298	1/2" Bit socket Torx tamperproof, long, TB45	1	49	911.4554	1/2" Bit socket RIBE, M10.1, 110 mm	1	60	911.1351	1/2" Bit socket spline (XZN), M6, 110 mm	1
39	917.1297	1/2" Bit socket Torx tamperproof, long, TB40	1	50	911.1995	1/2" Bit socket RIBE, M12, 110 mm	1	61	911.1350	1/2" Bit socket spline (XZN), M5, 110 mm	1
40	917.1296	1/2" Bit socket Torx tamperproof, long, TB30	1	51	911.1996	1/2" Bit socket RIBE, M13, 110 mm	1	62	911.4553	1/2" Bit socket RIBE, M16, 110 mm	1
41	917.1295	1/2" Bit socket Torx tamperproof, long, TB27	1	52	911.1997	1/2" Bit socket RIBE, M14, 110 mm	1	63	150.3101	1/2" V-Ribbed Alternator combination key Torx, T50	1
42	917.1294	1/2" Bit socket Torx tamperproof, long, TB25	1	53	911.5392	XZN bit socket, 1/2", deep, MB16	1	64	150.3102	1/2" V-Ribbed Alternator combination key XZN, M10, 115 mm	1
43	911.1921	1/2" Bit socket RIBE, M5, 110 mm	1	54	911.1356	1/2" Bit socket spline (XZN), M16, 110 mm	1				
44	911.1922	1/2" Bit socket RIBE, M6, 110 mm	1	55	911.1355	1/2" Bit socket spline (XZN), M14, 110 mm	1				

P 10
P 15
P 20
P 25
P 30
P 35
P 40
P 45
Individual parts S XL L M
Accessories

811.1111

M 1/2" Screwdriver bit set

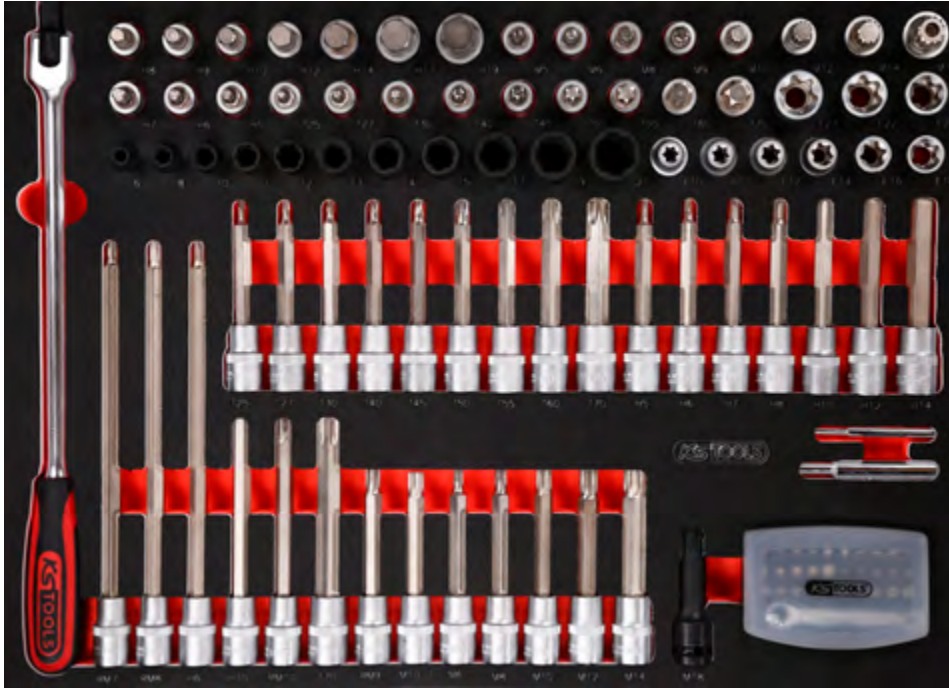

359, ^{EUR}—

111

568 x 398

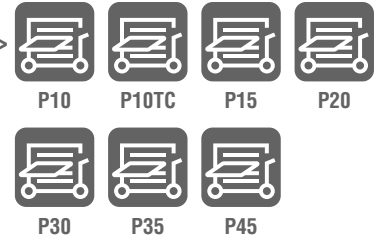

Pos.	Code	Description	pcs	Pos.	Code	Description	pcs	Pos.	Code	Description	pcs
1	917.1455	1/2" Flexi head drive handle	1	15	911.1345	1/2" Bit socket spline (XZN), M14, 55 mm	1	28	911.1370	1/2" Bit socket Torx, T70	1
2	911.1308	1/2" Bit socket hexagon, short, 8 mm	1	16	911.1348	1/2" Bit socket spline (XZN) tamperproof, M16, 55 mm	1	29	911.4326	1/2" Torx E Socket, E24	1
3	911.1309	1/2" Bit socket hexagon, short, 9 mm	1	17	911.1307	1/2" Bit socket hexagon, short, 7 mm	1	30	911.4325	1/2" Torx E Socket, E22	1
4	911.1310	1/2" Bit socket hexagon, short, 10 mm	1	18	911.1306	1/2" Bit socket hexagon, short, 6 mm	1	31	911.4324	1/2" Torx E Socket, E20	1
5	911.1312	1/2" Bit socket hexagon, short, 12 mm	1	19	911.1305	1/2" Bit socket hexagon, short, 5 mm	1	32	913.1473	1/4" Spiral profile impact socket, 6 mm	1
6	911.1314	1/2" Bit socket hexagon, short, 14 mm	1	20	911.1362	1/2" Bit socket Torx, T25	1	33	913.1408	1/4" Spiral profile impact socket, 8 mm	1
7	911.1317	1/2" Bit socket hexagon, short, 17 mm	1	21	911.1363	1/2" Bit socket Torx, T27	1	34	913.1410	1/4" Spiral profile impact socket, 10 mm	1
8	911.1319	1/2" Bit socket hexagon, short, 19 mm	1	22	911.1364	1/2" Bit socket Torx, T30	1	35	913.1470	1/4" Spiral profile impact socket, 11 mm	1
9	911.1340	1/2" Bit socket spline (XZN), M5, 55 mm	1	23	911.1365	1/2" Bit socket Torx, T40	1	36	913.1412	1/4" Spiral profile impact socket, 12 mm	1
10	911.1341	1/2" Bit socket spline (XZN), M6, 55 mm	1	24	911.1366	1/2" Bit socket Torx, T45	1	37	913.1468	1/2" Spiral profile impact socket, 13 mm	1
11	911.1342	1/2" Bit socket spline (XZN), M8, 55 mm	1	25	911.1367	1/2" Bit socket Torx, T50	1	38	913.1467	1/2" Spiral profile impact socket, 14 mm	1
12	911.1313	1/2" Bit socket spline (XZN), M9, 55 mm	1	26	911.1368	1/2" Bit socket Torx, T55	1	39	913.1466	1/2" Spiral profile impact socket, 15 mm	1
13	911.1343	1/2" Bit socket spline (XZN), M10, 55 mm	1	27	911.1369	1/2" Bit socket Torx, T60	1	40	913.1465	1/2" Spiral profile impact socket, 17 mm	1
14	911.1344	1/2" Bit socket spline (XZN), M12, 55 mm	1					41	913.1464	1/2" Spiral profile impact socket, 19 mm	1

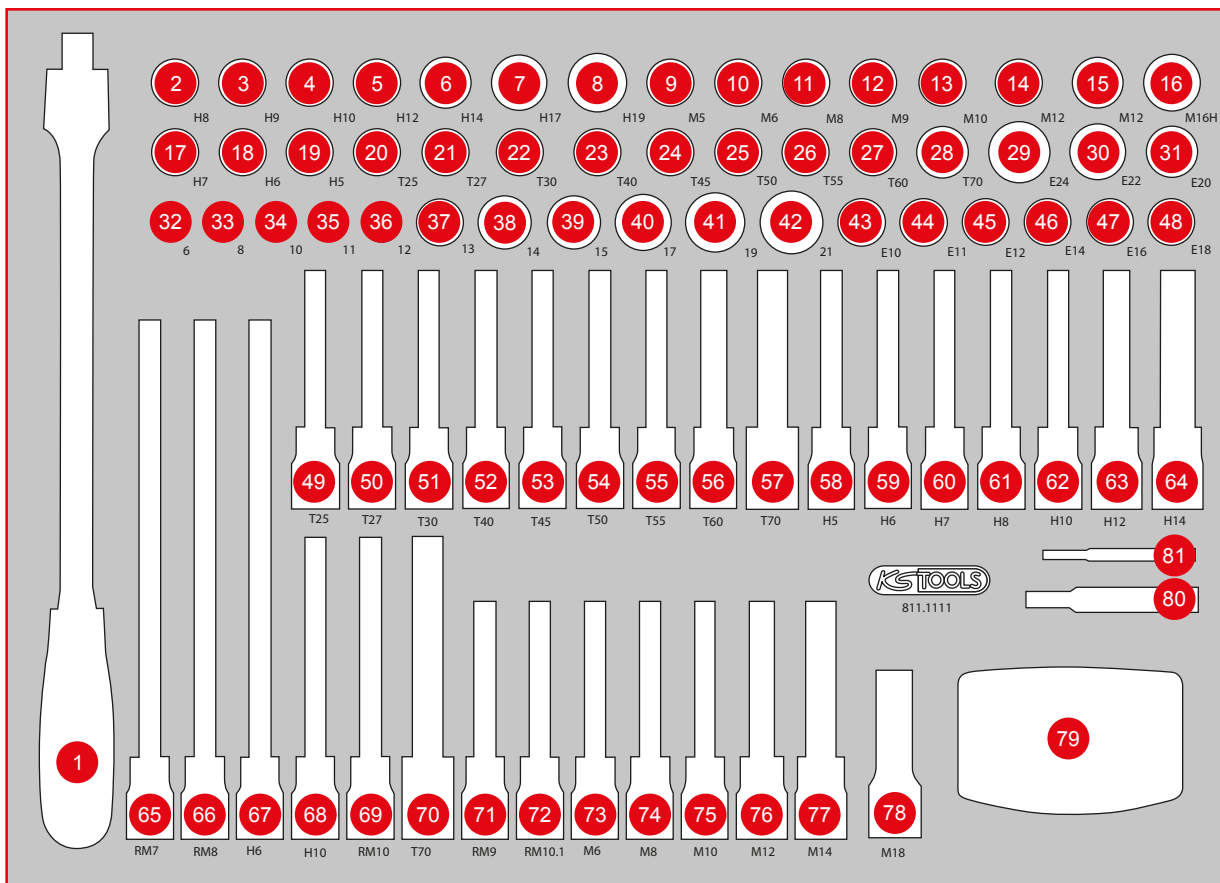

Pos.	Code	Description	pcs	Pos.	Code	Description	pcs	Pos.	Code	Description	pcs
42	913.1463	1/2" Spiral profile impact socket, 21 mm	1	56	911.1529	1/2" Bit socket Torx, long, T60	1	70	911.1942	1/2" Bit socket Torx, T70, 140 mm	1
43	911.4333	1/2" Torx E Socket, E10	1	57	911.1517	1/2" Bit socket Torx, long, T70	1	71	911.1925	1/2" Bit socket RIBE, M9, 110 mm	1
44	911.4334	1/2" Torx E Socket, E11	1	58	911.1325	1/2" Bit socket hexagon, long, 5 mm	1	72	911.4554	1/2" Bit socket RIBE, M10.1, 110 mm	1
45	911.4335	1/2" Torx E Socket, E12	1	59	911.1326	1/2" Bit socket hexagon, long, 6 mm	1	73	911.1351	1/2" Bit socket spline (XZN), M6, 110 mm	1
46	911.4336	1/2" Torx E Socket, E14	1	60	911.1327	1/2" Bit socket hexagon, long, 7 mm	1	74	911.1352	1/2" Bit socket spline (XZN), M8, 110 mm	1
47	911.4322	1/2" Torx E Socket, E16	1	61	911.1328	1/2" Bit socket hexagon, long, 8 mm	1	75	911.1353	1/2" Bit socket spline (XZN), M10, 110 mm	1
48	911.4323	1/2" Torx E Socket, E18	1	62	911.1330	1/2" Bit socket hexagon, long, 10 mm	1	76	911.1354	1/2" Bit socket spline (XZN), M12, 110 mm	1
49	911.1522	1/2" Bit socket Torx, long, T25	1	63	911.1332	1/2" Bit socket hexagon, long, 12 mm	1	77	911.1355	1/2" Bit socket spline (XZN), M14, 110 mm	1
50	911.1523	1/2" Bit socket Torx, long, T27	1	64	917.1332	1/2" Bit socket hexagon, long, 14 mm	1	78	515.1176	1/2" impact socket, XZN, M18 long	1
51	911.1524	1/2" Bit socket Torx, long, T30	1	65	911.1993	1/2" Bit socket RIBE, M7, 240 mm	1	79	911.2055	1/4" Bit set, 31 pcs	1
52	911.1525	1/2" Bit socket Torx, long, T40	1	66	911.1994	1/2" Bit socket RIBE, M8, 240 mm	1	80	913.1475	Extension drive, large	1
53	911.1526	1/2" Bit socket Torx, long, T45	1	67	911.5313	Hex bit socket, ball ended, long, 1/2", 6 mm	1	81	913.1474	Extension drive, small	1
54	911.1527	1/2" Bit socket Torx, long, T50	1	68	911.1960	1/2" Bit socket hexagon, 10 mm, 140 mm	1				
55	911.1528	1/2" Bit socket Torx, long, T55	31	69	911.1980	1/2" Bit socket RIBE, M10, 140 mm	1				

P 10
P 15
P 20
P 25
P 30
P 35
P 40
P 45
S XL L M
Individual parts
Accessories

811.0111

M 1/4" + 3/8" + 1/2" Socket spanner set



369, — ^{EUR}



568 x 398



Pos.	Code	Description	pcs	Pos.	Code	Description	pcs	Pos.	Code	Description	pcs
1	911.1462	1/4" Bit socket Torx tamperproof, TB10	1	21	911.1440	1/4" Bit socket hexagon, 7 mm	1	41	917.1404	1/4" Hexagonal socket, 4 mm	1
2	911.1463	1/4" Bit socket Torx tamperproof, TB15	1	22	911.1701	1/4" Bit socket five star tamperproof, TS10	1	42	917.1405	1/4" Hexagonal socket, 5 mm	1
3	911.1464	1/4" Bit socket Torx tamperproof, TB20	1	23	911.1702	1/4" Bit socket five star tamperproof, TS15	1	43	917.1406	1/4" Hexagonal socket, 6 mm	1
4	911.1465	1/4" Bit socket Torx tamperproof, TB25	1	24	911.1703	1/4" Bit socket five star tamperproof, TS20	1	44	917.1407	1/4" Hexagonal socket, 7 mm	1
5	911.1466	1/4" Bit socket Torx tamperproof, TB27	1	25	911.1704	1/4" Bit socket five star tamperproof, TS25	1	45	917.1408	1/4" Hexagonal socket, 8 mm	1
6	911.1467	1/4" Bit socket Torx tamperproof, TB30	1	26	911.1705	1/4" Bit socket five star tamperproof, TS27	1	46	917.1409	1/4" Hexagonal socket, 9 mm	1
7	911.1468	1/4" Bit socket Torx tamperproof, TB40	1	27	911.1706	1/4" Bit socket five star tamperproof, TS30	1	47	917.1410	1/4" Hexagonal socket, 10 mm	1
8	911.1442	1/4" Bit socket Torx, T10	1	28	911.1707	1/4" Bit socket five star tamperproof, TS40	1	48	917.1411	1/4" Hexagonal socket, 11 mm	1
9	911.1443	1/4" Bit socket Torx, T15	1	29	917.3812	3/8" Hexagonal socket, 12 mm	1	49	917.1412	1/4" Hexagonal socket, 12 mm	1
10	911.1444	1/4" Bit socket Torx, T20	1	30	917.3813	3/8" Hexagonal socket, 13 mm	1	50	917.1413	1/4" Hexagonal socket, 13 mm	1
11	911.1445	1/4" Bit socket Torx, T25	1	31	917.3814	3/8" Hexagonal socket, 14 mm	1	51	917.1221	1/2" Hexagonal socket, 21 mm	1
12	911.1449	1/4" Bit socket Torx, T27	1	32	917.3815	3/8" Hexagonal socket, 15 mm	1	52	917.1222	1/2" Hexagonal socket, 22 mm	1
13	911.1446	1/4" Bit socket Torx, T30	1	33	917.3816	3/8" Hexagonal socket, 16 mm	1	53	917.1224	1/2" Hexagonal socket, 24 mm	1
14	911.1447	1/4" Bit socket Torx, T40	1	34	917.3817	3/8" Hexagonal socket, 17 mm	1	54	917.1343	1/2" Hexagonal socket, 26 mm	1
15	911.1419	1/4" Bit socket slot, 5,5 mm	1	35	917.3818	3/8" Hexagonal socket, 18 mm	1	55	917.1227	1/2" Hexagonal socket, 27 mm	1
16	911.1416	1/4" Bit socket, PH2	1	36	917.3819	3/8" Hexagonal socket, 19 mm	1	56	917.1344	1/2" Hexagonal socket, 28 mm	1
17	911.1436	1/4" Bit socket hexagon, 3 mm	1	37	917.3808	3/8" Hexagonal socket, 8 mm	1	57	917.1230	1/2" Hexagonal socket, 30 mm	1
18	911.1437	1/4" Bit socket hexagon, 4 mm	1	38	917.3809	3/8" Hexagonal socket, 9 mm	1	58	917.1232	1/2" Hexagonal socket, 32 mm	1
19	911.1438	1/4" Bit socket hexagon, 5 mm	1	39	917.3810	3/8" Hexagonal socket, 10 mm	1	59	917.1210	1/2" Hexagonal socket, 10 mm	1
20	911.1439	1/4" Bit socket hexagon, 6 mm	1	40	917.3811	3/8" Hexagonal socket, 11 mm	1	60	917.1211	1/2" Hexagonal socket, 11 mm	1

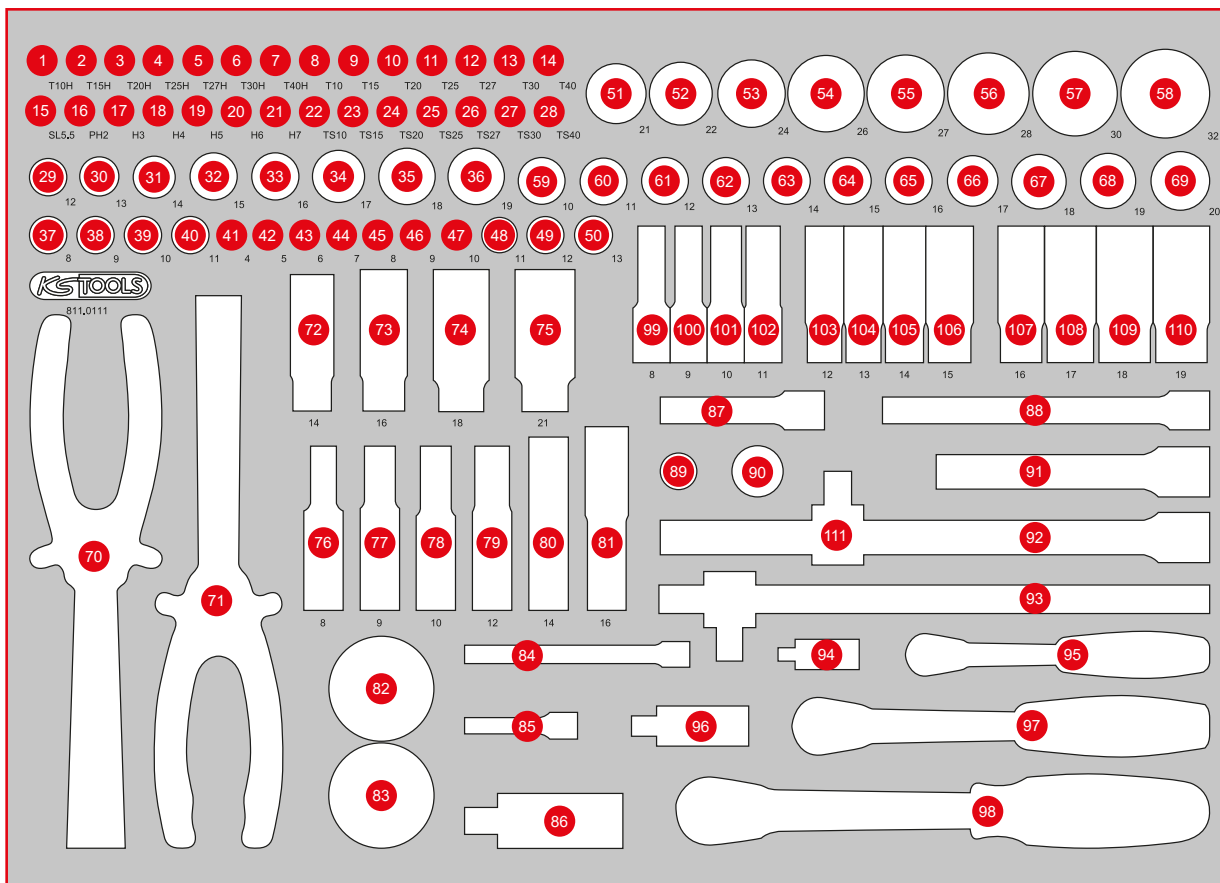

Pos.	Code	Description	pcs	Pos.	Code	Description	pcs	Pos.	Code	Description	pcs
61	917.1212	1/2" Hexagonal socket, 12 mm	1	79	500.7304	3/8" Glow plug joint sockets, short, 75 mm, 12 mm	1	96	911.3850	3/8" Universal joint	1
62	917.1213	1/2" Hexagonal socket, 13 mm	1	80	500.7305	3/8" Glow plug joint sockets, short, 75 mm, 14 mm	1	97	920.3890	3/8" SlimPOWER Reversible ratchet, 72 teeth	1
63	917.1214	1/2" Hexagonal socket, 14 mm	1	81	500.7306	3/8" Glow plug joint sockets, short, 75 mm, 16 mm	1	98	920.1290	1/2" SlimPOWER Reversible ratchet, 72 teeth	1
64	917.1215	1/2" Hexagonal socket, 15 mm	1	82	914.1410	Mini hand reversible ratchet, 1/4", 72 teethh	1	99	917.3828	3/8" Hexagonal socket, deep, 8 mm	1
65	917.1216	1/2" Hexagonal socket, 16 mm	1	83	914.3810	Mini hand reversible ratchet, 3/8", 72 teethh	1	100	917.3829	3/8" Hexagonal socket, deep, 9 mm	1
66	917.1217	1/2" Hexagonal socket, 17 mm	1	84	911.1424	1/4" Extension with hexagon drive, 100 mm	1	101	917.3830	3/8" Hexagonal socket, deep, 10 mm	1
67	917.1218	1/2" Hexagonal socket, 18 mm	1	85	911.1423	1/4" Extension with hexagon drive, 50 mm	1	102	917.3831	3/8" Hexagonal socket, deep, 11 mm	1
68	917.1219	1/2" Hexagonal socket, 19 mm	1	86	911.1250	1/2" Universal joint	1	103	917.3832	3/8" Hexagonal socket, deep, 12 mm	1
69	917.1220	1/2" Hexagonal socket, 20 mm	1	87	911.3801	3/8" Extension with knurling, 75 mm	1	104	917.3833	3/8" Hexagonal socket, deep, 13 mm	1
70	500.7310	Glow plug pliers, angled, 235 mm	1	88	911.3802	3/8" Extension with knurling, 150 mm	1	105	917.3834	3/8" Hexagonal socket, deep, 14 mm	1
71	500.7330	Glow plug pliers, 265 mm	1	89	911.3897	3/8" Reducing adaptor, 3/8" F x 1/4" M	1	106	917.3835	3/8" Hexagonal socket, deep, 15 mm	1
72	911.3990	3/8" Special spark plug socket, thin-walled, 14 mm	1	90	911.3826	3/8" Slider/Reducing adaptor, 1/2" F x 3/8" M	1	107	917.3836	3/8" Hexagonal socket, deep, 16 mm	1
73	911.3804	3/8" Spark plug socket, 16 mm	1	91	911.1202	1/2" Extensions, 125 mm	1	108	917.3837	3/8" Hexagonal socket, deep, 17 mm	1
74	911.3823	3/8" Spark plug socket, 18 mm	1	92	911.1203	1/2" Extensions, 250 mm	1	109	917.3838	3/8" Hexagonal socket, deep, 18 mm	1
75	911.3805	3/8" Spark plug socket, 21 mm	1	93	911.1204	Sliding T-bar, 1/2", 250 mm	1	110	917.3839	3/8" Hexagonal socket, deep, 19 mm	1
76	500.7301	3/8" Glow plug joint sockets, short, 75 mm, 8 mm	1	94	911.1450	1/4" Universal joint	1	111	911.1207	3/8" Sliding adaptor, 3/8" F x 1/2" M	1
77	500.7302	3/8" Glow plug joint sockets, short, 75 mm, 9 mm	1	95	920.1490	1/4" SlimPOWER Reversible ratchet, 72 teeth	1				
78	500.7303	3/8" Glow plug joint sockets, short, 75 mm, 10 mm	1								

P 10
P 15
P 20
P 25
P 30
P 35
P 40
P 45
Individual parts S XL L M
Accessories

811.0139

M 1/4" + 3/8" + 1/2" Socket spanner set

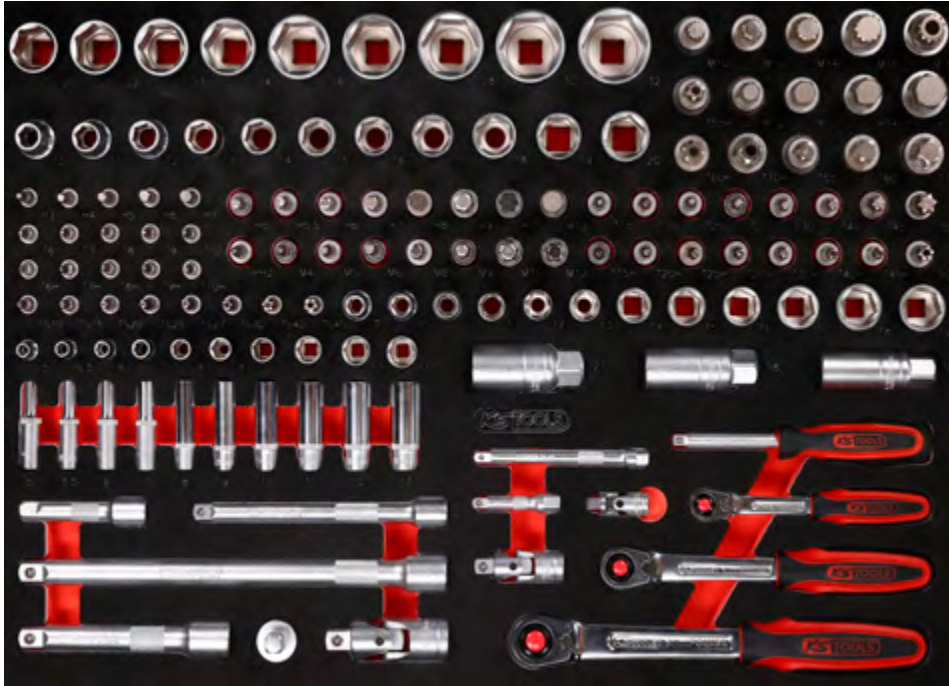

339, ^{EUR}-

139

568 x 398

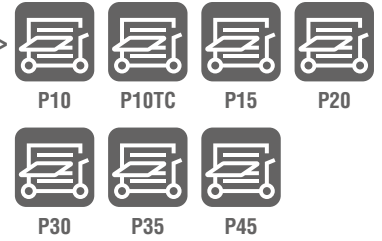

Pos.	Code	Description	pcs
1	917.1221	1/2" Hexagonal socket, 21 mm	1
2	917.1222	1/2" Hexagonal socket, 22 mm	1
3	917.1223	1/2" Hexagonal socket, 23 mm	1
4	917.1224	1/2" Hexagonal socket, 24 mm	1
5	917.1343	1/2" Hexagonal socket, 26 mm	1
6	917.1227	1/2" Hexagonal socket, 27 mm	1
7	917.1344	1/2" Hexagonal socket, 28 mm	1
8	917.1230	1/2" Hexagonal socket, 30 mm	1
9	917.1232	1/2" Hexagonal socket, 32 mm	1
10	917.1210	1/2" Hexagonal socket, 10 mm	1
11	917.1211	1/2" Hexagonal socket, 11 mm	1
12	917.1212	1/2" Hexagonal socket, 12 mm	1
13	917.1213	1/2" Hexagonal socket, 13 mm	1
14	917.1214	1/2" Hexagonal socket, 14 mm	1
15	917.1215	1/2" Hexagonal socket, 15 mm	1
16	917.1216	1/2" Hexagonal socket, 16 mm	1
17	917.1217	1/2" Hexagonal socket, 17 mm	1
18	917.1218	1/2" Hexagonal socket, 18 mm	1
19	917.1219	1/2" Hexagonal socket, 19 mm	1
20	917.1220	1/2" Hexagonal socket, 20 mm	1
21	911.1343	1/2" Bit socket spline (XZN), M10, 55 mm	1
22	911.1344	1/2" Bit socket spline (XZN), M12, 55 mm	1
23	911.1345	1/2" Bit socket spline (XZN), M14, 55 mm	1
24	911.1346	1/2" Bit socket spline (XZN), M16, 55 mm	1

Pos.	Code	Description	pcs
25	911.1348	1/2" Bit socket spline (XZN) tamperproof, M16, 55 mm	1
26	911.1378	1/2" Bit socket Torx tamperproof, TB55	1
27	911.1310	1/2" Bit socket hexagon, short, 10 mm	1
28	911.1312	1/2" Bit socket hexagon, short, 12 mm	1
29	911.1314	1/2" Bit socket hexagon, short, 14 mm	1
30	911.1317	1/2" Bit socket hexagon, short, 17 mm	1
31	911.1379	1/2" Bit socket Torx tamperproof, TB60	1
32	911.1380	1/2" Bit socket Torx tamperproof, TB70	1
33	911.1368	1/2" Bit socket Torx, T55	1
34	911.1369	1/2" Bit socket Torx, T60	1
35	911.1370	1/2" Bit socket Torx, T70	1
36	911.1436	1/4" Bit socket hexagon, 3 mm	1
37	911.1437	1/4" Bit socket hexagon, 4 mm	1
38	911.1438	1/4" Bit socket hexagon, 5 mm	1
39	911.1439	1/4" Bit socket hexagon, 6 mm	1
40	911.1440	1/4" Bit socket hexagon, 7 mm	1
41	911.4407	1/4" Bit socket Torx, T6	1
42	911.4362	1/4" Bit socket Torx, T7	1
43	911.1448	1/4" Bit socket Torx, T8	1
44	911.1478	1/4" Bit socket Torx, T9	1
45	911.1442	1/4" Bit socket Torx, T10	1
46	917.1456	1/4" Bit socket Torx tamperproof, TB6	1
47	917.1457	1/4" Bit socket Torx tamperproof, TB7	1

Pos.	Code	Description	pcs
48	911.1461	1/4" Bit socket Torx tamperproof, TB8	1
49	911.1485	1/4" Bit socket Torx tamperproof, TB9	1
50	911.1462	1/4" Bit socket Torx tamperproof, TB10	1
51	911.1701	1/4" Bit socket five star tamperproof, TS10	1
52	911.1702	1/4" Bit socket five star tamperproof, TS15	1
53	911.1703	1/4" Bit socket five star tamperproof, TS20	1
54	911.1704	1/4" Bit socket five star tamperproof, TS25	1
55	911.1705	1/4" Bit socket five star tamperproof, TS27	1
56	911.1706	1/4" Bit socket five star tamperproof, TS30	1
57	911.1707	1/4" Bit socket five star tamperproof, TS40	1
58	911.1708	1/4" Bit socket five star tamperproof, TS45	1
59	911.3865	3/8" Bit socket hexagon, 5 mm	1
60	911.3865	3/8" Bit socket hexagon, 5,5 mm	1
61	911.3866	3/8" Bit socket hexagon, 6 mm	1
62	911.3867	3/8" Bit socket hexagon, 7 mm	1
63	911.3868	3/8" Bit socket hexagon, 8 mm	1
64	917.3969	3/8" Bit socket hexagon, 9 mm	1
65	917.3857	3/8" Bit socket hexagon, 10 mm	1
66	911.3862	3/8" Bit socket hexagon, 12 mm	1
67	911.3869	3/8" Bit socket Torx, T15	1
68	911.3870	3/8" Bit socket Torx, T20	1
69	911.3871	3/8" Bit socket Torx, T25	1
70	911.3872	3/8" Bit socket Torx, T27	1
71	911.3873	3/8" Bit socket Torx, T30	1

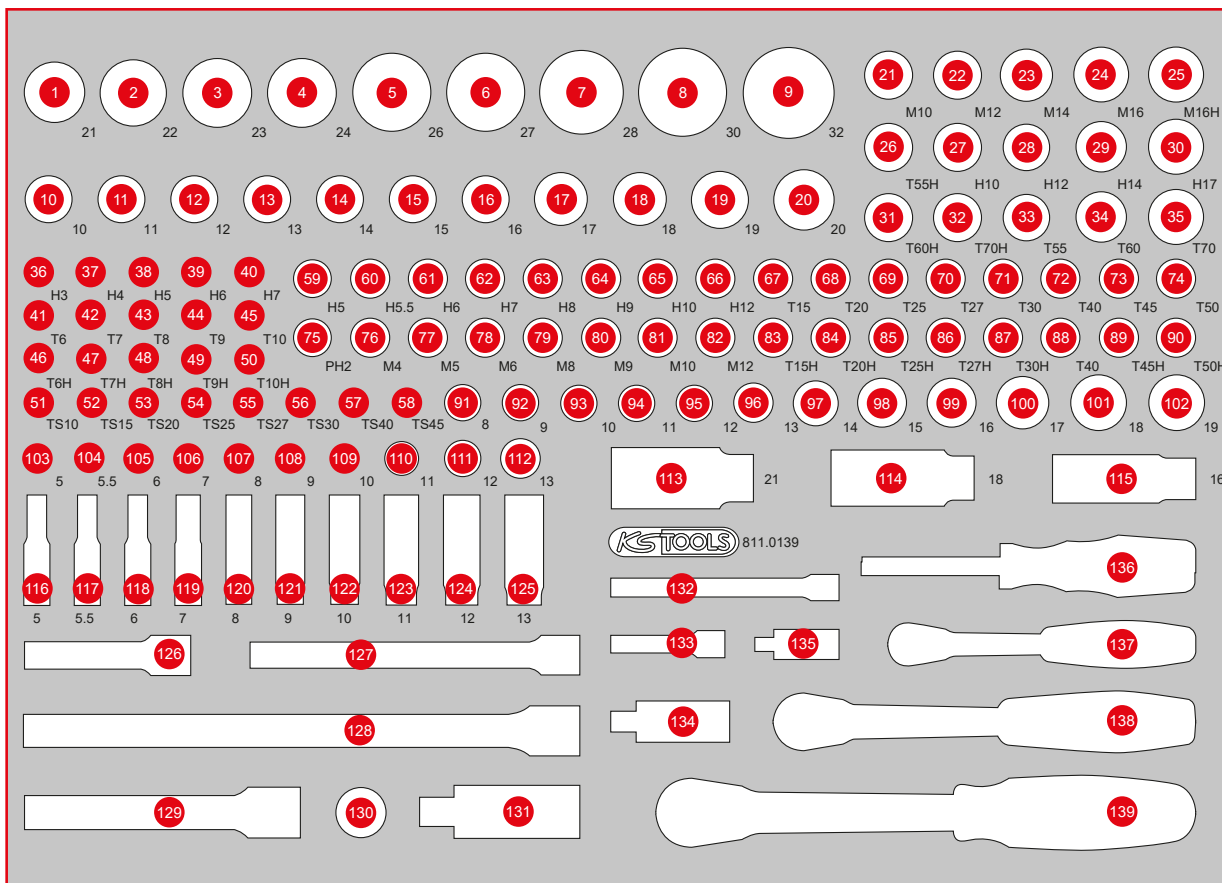

Pos.	Code	Description	pcs	Pos.	Code	Description	pcs	Pos.	Code	Description	pcs
72	911.3874	3/8" Bit socket Torx, T40	1	96	917.3813	3/8" Hexagonal socket, 13 mm	1	120	917.1428	1/4" Hexagonal socket, deep, 8 mm	1
73	911.3885	3/8" Bit socket Torx, T45	1	97	917.3814	3/8" Hexagonal socket, 14 mm	1	121	917.1429	1/4" Hexagonal socket, deep, 9 mm	1
74	911.3884	3/8" Bit socket Torx, T50	1	98	917.3815	3/8" Hexagonal socket, 15 mm	1	122	917.1430	1/4" Hexagonal socket, deep, 10 mm	1
75	911.3876	3/8" Bit socket, PH2	1	99	917.3816	3/8" Hexagonal socket, 16 mm	1	123	917.1431	1/4" Hexagonal socket, deep, 11 mm	1
76	911.3918	3/8" Bit socket spline (XZN), M4	1	100	917.3817	3/8" Hexagonal socket, 17 mm	1	124	917.1432	1/4" Hexagonal socket, deep, 12 mm	1
77	911.3915	3/8" Bit socket spline (XZN), M5	1	101	917.3818	3/8" Hexagonal socket, 18 mm	1	125	917.1433	1/4" Hexagonal socket, deep, 13 mm	1
78	911.3916	3/8" Bit socket spline (XZN), M6	1	102	917.3819	3/8" Hexagonal socket, 19 mm	1	126	911.3801	3/8" Extension with knurling, 75 mm	1
79	911.3917	3/8" Bit socket spline (XZN), M8	1	103	917.1405	1/4" Hexagonal socket, 5 mm	1	127	911.3802	3/8" Extension with knurling, 150 mm	1
80	917.3901	3/8" Bit socket spline (XZN), M9	1	104	917.14055	1/4" Hexagonal socket, 5.5 mm	1	128	911.1203	1/2" Extensions, 250 mm	1
81	911.3920	3/8" Bit socket spline (XZN), M10	1	105	917.1406	1/4" Hexagonal socket, 6 mm	1	129	911.1202	1/2" Extensions, 125 mm	1
82	917.3903	3/8" Bit socket spline (XZN), M12	1	106	917.1407	1/4" Hexagonal socket, 7 mm	1	130	911.1207	3/8" Sliding adaptor, 3/8" F x 1/2" M	1
83	911.3961	3/8" Bit socket Torx tamperproof, TB15	1	107	917.1408	1/4" Hexagonal socket, 8 mm	1	131	911.1250	1/2" Universal joint	1
84	911.3962	3/8" Bit socket Torx tamperproof, TB20	1	108	917.1409	1/4" Hexagonal socket, 9 mm	1	132	911.1424	1/4" Extension with hexagon drive, 100 mm	1
85	911.3963	3/8" Bit socket Torx tamperproof, TB25	1	109	917.1410	1/4" Hexagonal socket, 10 mm	1	133	911.1423	1/4" Extension with hexagon drive, 50 mm	1
86	911.3964	3/8" Bit socket Torx tamperproof, TB27	1	110	917.1411	1/4" Hexagonal socket, 11 mm	1	134	911.3850	3/8" Universal joint	1
87	911.3965	3/8" Bit socket Torx tamperproof, TB30	1	111	917.1412	1/4" Hexagonal socket, 12 mm	1	135	911.1450	1/4" Universal joint	1
88	911.3966	3/8" Bit socket Torx tamperproof, TB40	1	112	917.1413	1/4" Hexagonal socket, 13 mm	1	136	911.1434	1/4" Square drive screwdriver, 150 mm	1
89	911.3967	3/8" Bit socket Torx tamperproof, TB45	1	113	911.3805	3/8" Spark plug socket, 21 mm	1	137	920.1490	1/4" SlimPOWER Reversible ratchet, 72 teeth	1
90	911.3968	3/8" Bit socket Torx tamperproof, TB50	1	114	911.3823	3/8" Spark plug socket, 18 mm	1	138	920.3890	3/8" SlimPOWER Reversible ratchet, 72 teeth	1
91	917.3808	3/8" Hexagonal socket, 8 mm	1	115	911.3804	3/8" Spark plug socket, 16 mm	1	139	920.1290	1/2" SlimPOWER Reversible ratchet, 72 teeth	1
92	917.3809	3/8" Hexagonal socket, 9 mm	1	116	917.1527	1/4" Hexagonal socket, deep, 5mm	1				
93	917.3810	3/8" Hexagonal socket, 10 mm	1	117	917.1528	1/4" Hexagonal socket, deep, 5.5 mm	1				
94	917.3811	3/8" Hexagonal socket, 11 mm	1	118	917.1426	1/4" Hexagonal socket, deep, 6 mm	1				
95	917.3812	3/8" Hexagonal socket, 12 mm	1	119	917.1427	1/4" Hexagonal socket, deep, 7 mm	1				

P 10
P 15
P 20
P 25
P 30
P 35
P 40
P 45
Individual parts
S XL L M
Accessories

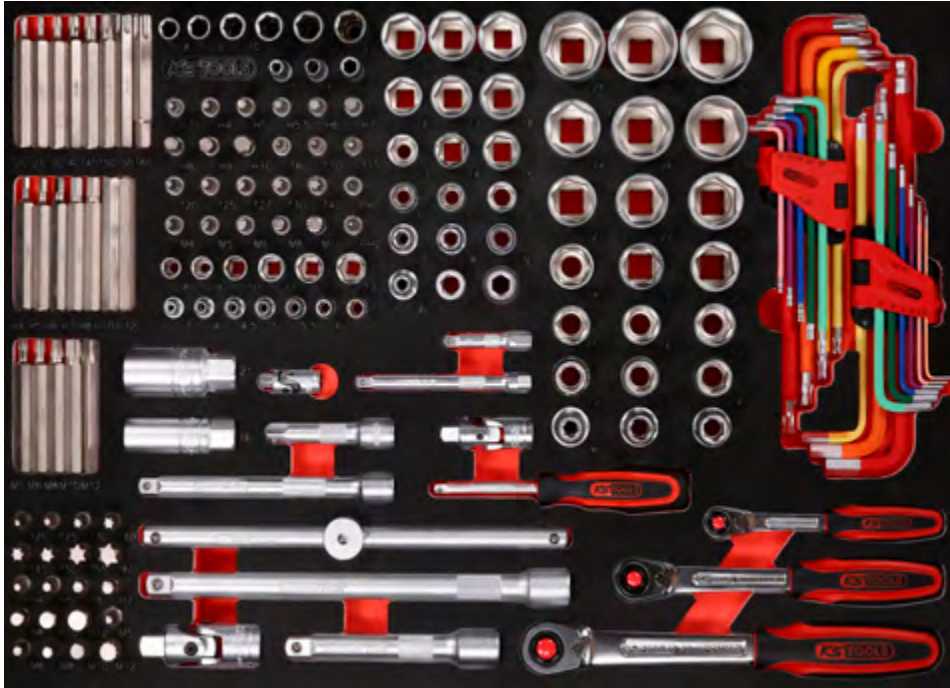
M 1/4" + 3/8" + 1/2" Socket spanner set

309, ^{EUR}—



P10

P10TC

P15

P20



P30

P35

P45

Pos.	Code	Description	pcs	Pos.	Code	Description	pcs	Pos.	Code	Description	pcs
1	975.2020	10 mm Bit Torx, 75 mm, T20	1	26	930.2050	10 mm Bit Torx, 30 mm, T50	1	51	911.1437	1/4" Bit socket hexagon, 4 mm	1
2	975.2025	10 mm Bit Torx, 75 mm, T25	1	27	930.2055	10 mm Bit Torx, 30 mm, T55	1	52	911.1438	1/4" Bit socket hexagon, 5 mm	1
3	975.2030	10 mm Bit Torx, 75 mm, T30	1	28	930.2060	10 mm Bit Torx, 30 mm, T60	1	53	911.14385	1/4" Bit socket hexagon, 5,5 mm	1
4	975.2040	10 mm Bit Torx, 75 mm, T40	1	29	930.1004	10 mm Bit hexagonal, 30 mm, 4 mm	1	54	911.1439	1/4" Bit socket hexagon, 6 mm	1
5	975.2045	10 mm Bit Torx, 75 mm, T45	1	30	930.1005	10 mm Bit hexagonal, 30 mm, 5 mm	1	55	911.1440	1/4" Bit socket hexagon, 7 mm	1
6	975.2050	10 mm Bit Torx, 75 mm, T50	1	31	930.1006	10 mm Bit hexagonal, 30 mm, 6 mm	1	56	911.1441	1/4" Bit socket hexagon, 8 mm	1
7	975.2055	10 mm Bit Torx, 75 mm, T55	1	32	930.1007	10 mm Bit hexagonal, 30 mm, 7 mm	1	57	917.1454	1/4" Bit socket hexagon, 9 mm	1
8	975.2060	10 mm Bit Torx, 75 mm, T60	1	33	930.1008	10 mm Bit hexagonal, 30 mm, 8 mm	1	58	917.1452	1/4" Bit socket hexagon, 10 mm	1
9	975.1004	10mm Bit hexagonal, 75mm, 4mm	1	34	930.1010	10 mm Bit hexagonal, 30 mm, 10 mm	1	59	911.1448	1/4" Bit socket Torx, T8	1
10	975.1005	10 mm Bit hexagonal, 75 mm, 5 mm	1	35	930.1012	10 mm Bit hexagonal, 30 mm, 12 mm	1	60	911.1442	1/4" Bit socket Torx, T10	1
11	975.1006	10 mm Bit hexagonal, 75 mm, 6 mm	1	36	930.3005	10 mm Bit spline XZN, 30 mm, M5	1	61	911.1443	1/4" Bit socket Torx, T15	1
12	975.1007	10 mm Bit hexagonal, 75 mm, 7 mm	1	37	930.3006	10 mm Bit spline XZN, 30 mm, M6	1	62	911.1444	1/4" Bit socket Torx, T20	1
13	975.1008	10 mm Bit hexagonal, 75 mm, 8 mm	1	38	930.3008	10 mm Bit spline XZN, 30 mm, M8	1	63	911.1445	1/4" Bit socket Torx, T25	1
14	975.1010	10 mm Bit hexagonal, 75 mm, 10 mm	1	39	930.3010	10 mm Bit spline XZN, 30 mm, M10	1	64	911.1449	1/4" Bit socket Torx, T27	1
15	975.1012	10 mm Bit hexagonal, 75 mm, 12 mm	1	40	930.3012	10 mm Bit spline XZN, 30 mm, M12	1	65	911.1446	1/4" Bit socket Torx, T30	1
16	975.3005	10mm Bit spline XZN, 75 mm, M5	1	41	917.1428	1/4" Hexagonal socket, deep, 8 mm	1	66	911.1447	1/4" Bit socket Torx, T40	1
17	975.3006	10 mm Bit spline XZN, 75 mm, M6	1	42	917.1429	1/4" Hexagonal socket, deep, 9 mm	1	67	911.1415	1/4" Bit socket, PH1	1
18	975.3008	10 mm Bit spline XZN, 75 mm, M8	1	43	917.1430	1/4" Hexagonal socket, deep, 10 mm	1	68	917.1541	1/4" Bit socket spline (XZN), M4	1
19	975.3010	10 mm Bit spline XZN, 75 mm, M10	1	44	917.1431	1/4" Hexagonal socket, deep, 11 mm	1	69	917.1542	1/4" Bit socket spline (XZN), M5	1
20	975.3012	10 mm Bit spline XZN, 75 mm, M12	1	45	917.1432	1/4" Hexagonal socket, deep, 12 mm	1	70	917.1543	1/4" Bit socket spline (XZN), M6	1
21	930.2020	10 mm Bit Torx, 30 mm, T20	1	46	917.1433	1/4" Hexagonal socket, deep, 13 mm	1	71	917.1545	1/4" Bit socket spline (XZN), M8	1
22	930.2025	10 mm Bit Torx, 30 mm, T25	1	47	917.1527	1/4" Hexagonal socket, deep, 5 mm	1	72	917.1546	1/4" Bit socket spline (XZN), M10	1
23	930.2030	10 mm Bit Torx, 30 mm, T30	1	48	917.1426	1/4" Hexagonal socket, deep, 6 mm	1	73	911.1416	1/4" Bit socket, PH2	1
24	930.2040	10 mm Bit Torx, 30 mm, T40	1	49	917.1427	1/4" Hexagonal socket, deep, 7 mm	1	74	917.1408	1/4" Hexagonal socket, 8 mm	1
25	930.2045	10 mm Bit Torx, 30 mm, T45	1	50	911.1436	1/4" Bit socket hexagon, 3 mm	1	75	917.1409	1/4" Hexagonal socket, 9 mm	1

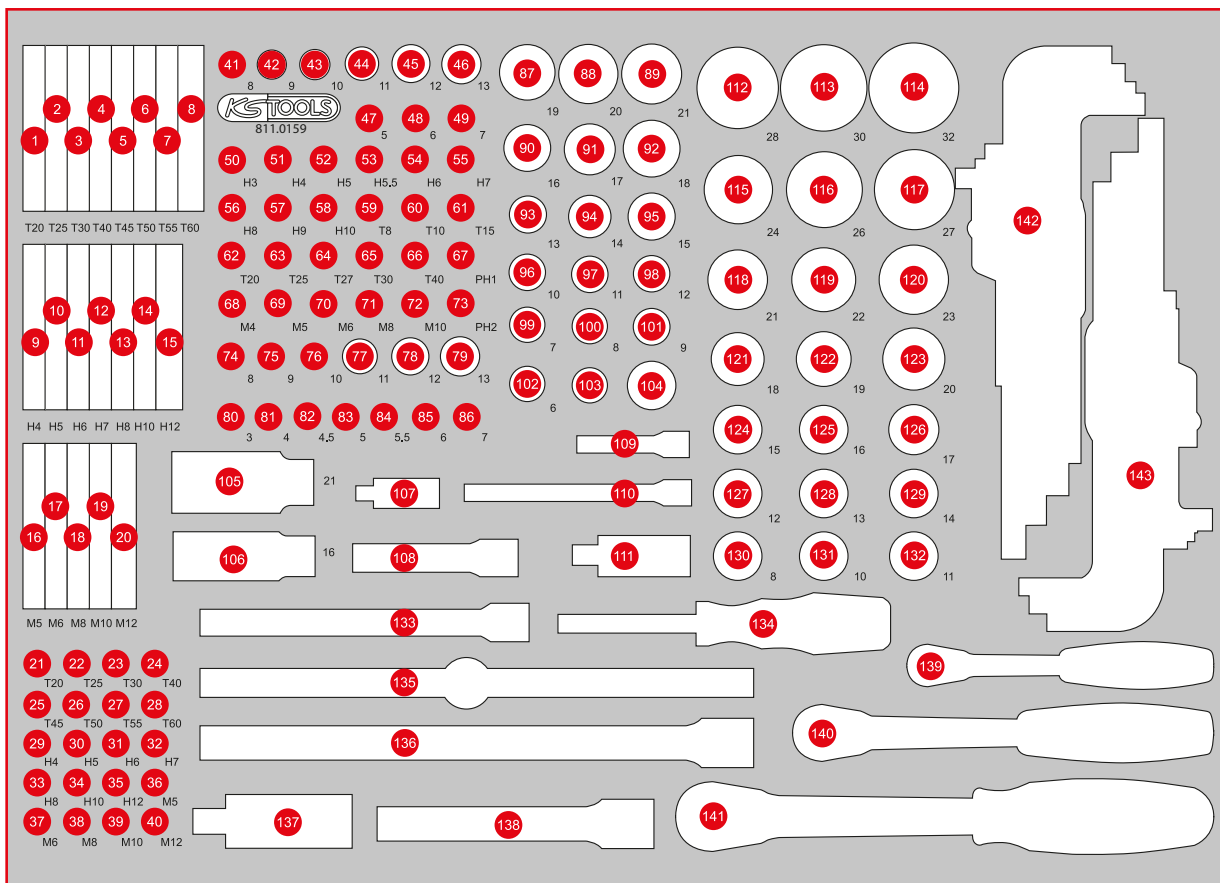

Pos.	Code	Description	pcs	Pos.	Code	Description	pcs	Pos.	Code	Description	pcs
76	917.1410	1/4" Hexagonal socket, 10 mm	1	101	917.3809	3/8" Hexagonal socket, 9 mm	1	126	917.1217	1/2" Hexagonal socket, 17 mm	1
77	917.1411	1/4" Hexagonal socket, 11 mm	1	102	917.3806	3/8" Hexagonal socket, 6 mm	1	127	917.1212	1/2" Hexagonal socket, 12 mm	1
78	917.1412	1/4" Hexagonal socket, 12 mm	1	103	911.4311	3/8" Bit adaptor socket, for bits 10mm	1	128	917.1213	1/2" Hexagonal socket, 13 mm	1
79	917.1413	1/4" Hexagonal socket, 13 mm	1	105	911.3805	3/8" Spark plug socket, 21 mm	1	129	917.1214	1/2" Hexagonal socket, 14 mm	1
80	917.1445	1/4" Hexagonal socket, 3 mm	1	105	911.4312	1/2" Bit adaptor socket, for bits 10 mm	1	130	917.1340	1/2" Hexagonal socket, 8 mm	1
81	917.1404	1/4" Hexagonal socket, 4 mm	1	106	911.3804	3/8" Spark plug socket, 16 mm	1	131	917.1210	1/2" Hexagonal socket, 10 mm	1
82	917.14045	1/4" Hexagonal socket, 4,5 mm	1	107	911.1450	1/4" Universal joint	1	132	917.1211	1/2" Hexagonal socket, 11 mm	1
83	917.1405	1/4" Hexagonal socket, 5 mm	1	108	911.3801	3/8" Extension with knurling, 75 mm	1	133	911.3802	3/8" Extension with knurling, 150 mm	1
84	917.14055	1/4" Hexagonal socket, 5,5 mm	1	109	911.1423	1/4" Extension with hexagon drive, 50 mm	1	134	911.1434	1/4" Square drive screwdriver, 150 mm	1
85	917.1406	1/4" Hexagonal socket, 6 mm	1	110	911.1424	1/4" Extension with hexagon drive, 100 mm	1	135	911.1204	Sliding T-bar, 1/2", 250 mm	1
86	917.1407	1/4" Hexagonal socket, 7 mm	1	111	911.3850	3/8" Universal joint	1	136	911.1203	1/2" Extensions, 250 mm	1
87	917.3819	3/8" Hexagonal socket, 19 mm	1	112	917.1344	1/2" Hexagonal socket, 28 mm	1	137	911.1250	1/2" Universal joint	1
88	917.3820	3/8" Hexagonal socket, 20 mm	1	113	917.1230	1/2" Hexagonal socket, 30 mm	1	138	911.1202	1/2" Extensions, 125 mm	1
89	917.3821	3/8" Hexagonal socket, 21 mm	1	114	917.1232	1/2" Hexagonal socket, 32 mm	1	139	920.1490	1/4" SlimPOWER Reversible ratchet, 72 teeth	1
90	917.3816	3/8" Hexagonal socket, 16 mm	1	115	917.1224	1/2" Hexagonal socket, 24 mm	1	140	920.3890	3/8" SlimPOWER Reversible ratchet, 72 teeth	1
91	917.3817	3/8" Hexagonal socket, 17 mm	1	116	917.1343	1/2" Hexagonal socket, 26 mm	1	141	920.1290	1/2" SlimPOWER Reversible ratchet, 72 teeth	1
92	917.3818	3/8" Hexagonal socket, 18 mm	1	117	917.1227	1/2" Hexagonal socket, 27 mm	1	142	151.5210	Ball head Torx angled socket wrench set, extra long, 9 pcs	9
93	917.3813	3/8" Hexagonal socket, 13 mm	1	118	917.1221	1/2" Hexagonal socket, 21 mm	1	143	151.4420	Ball ended hexagon key wrench set, extra long, 9 pcs	9
94	917.3814	3/8" Hexagonal socket, 14 mm	1	119	917.1222	1/2" Hexagonal socket, 22 mm	1				
95	917.3815	3/8" Hexagonal socket, 15 mm	1	120	917.1223	1/2" Hexagonal socket, 23 mm	1				
96	917.3810	3/8" Hexagonal socket, 10 mm	1	121	917.1218	1/2" Hexagonal socket, 18 mm	1				
97	917.3811	3/8" Hexagonal socket, 11 mm	1	122	917.1219	1/2" Hexagonal socket, 19 mm	1				
98	917.3812	3/8" Hexagonal socket, 12 mm	1	123	917.1220	1/2" Hexagonal socket, 20 mm	1				
99	917.3807	3/8" Hexagonal socket, 7 mm	1	124	917.1215	1/2" Hexagonal socket, 15 mm	1				
100	917.3808	3/8" Hexagonal socket, 8 mm	1	125	917.1216	1/2" Hexagonal socket, 16 mm	1				

P 10
P 15
P 20
P 25
P 30
P 35
P 40
P 45
Individual parts S XL L M
Accessories

811.0092

M 1/4" + 3/8" + 1/2" Socket spanner set



309, ^{EUR}—

92

568 x 398

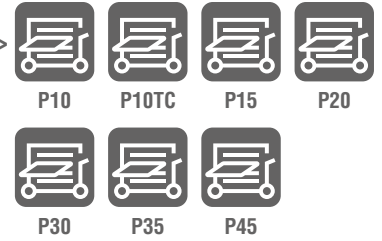

Pos.	Code	Description	pcs	Pos.	Code	Description	pcs	Pos.	Code	Description	pcs
1	914.1220	1/2" SlimPOWER Telescopic reversible ratchet, 72 teeth	1	13	911.1202	1/2" Extensions, 125 mm	1	28	911.4000	3/8" 12 Point socket, 1/2"	1
2	914.3815	3/8" MODIFIX mini T-handle swivel head ratchet, 72 teeth, 0° + 90°	1	14	911.1203	1/2" Extensions, 250 mm	1	29	911.4001	3/8" 12 Point socket, 9/16"	1
3	914.1405	1/4" MODIFIX mini T-handle swivel head ratchet, 72 teeth	1	15	911.3850	3/8" Universal joint	1	30	911.4003	3/8" 12 Point socket, 5/8"	1
4	151.4520	KBall ended hexagon key wrench set, extra long, 9 pcs, imperial	9	16	911.3826	3/8" Sliding / reducing adaptor, 1/2" F x 3/8" M	1	31	911.4004	3/8" 12 Point socket, 11/16"	1
5	911.1250	1/2" Universal joint	1	17	917.1474	1/4" 12 Point socket, 3/16"	1	32	911.4005	3/8" 12 Point socket, 3/4"	1
6	911.1423	1/4" Extension with hexagon drive, 50 mm	1	18	917.1475	1/4" 12 Point socket, 7/32"	1	33	917.1380	1/2" 12 Point socket, 13/16"	1
7	911.1424	1/4" Extension with hexagon drive, 100 mm	1	19	917.1476	1/4" 12 Point socket, 1/4"	1	34	917.1381	1/2" 12 Point socket, 7/8"	1
8	911.1451	1/4" Extension with hexagon drive, 150 mm	1	20	917.1477	1/4" 12 Point socket, 9/32"	1	35	917.1382	1/2" 12 Point socket, 15/16"	1
9	911.3852	3/8" Extension with knurling, 45 mm	1	21	917.1478	1/4" 12 Point socket, 5/16"	1	36	917.1383	1/2" 12 Point socket, 1"	1
10	911.3801	3/8" Extension with knurling, 75 mm	1	22	917.1479	1/4" 12 Point socket, 11/32"	1	37	917.1384	1/2" 12 Point socket, 1.1/16"	1
11	911.3802	3/8" Extension with knurling, 150 mm	1	23	917.1480	1/4" 12 Point socket, 3/8"	1	38	917.1385	1/2" 12 Point socket, 1.1/8"	1
12	911.3803	3/8" Extension with knurling, 250 mm	1	24	917.1481	1/4" 12 Point socket, 7/16"	1	39	917.1386	1/2" 12 Point socket, 1.3/16"	1
				25	917.1482	1/4" 12 Point socket, 1/2"	1	40	917.1387	1/2" 12 Point socket, 1.1/4"	1
				26	917.3851	3/8" 12 Point socket, 3/8"	1	41	917.1565	1/4" 12 Point socket deep 3/16"	1
				27	917.3852	3/8" 12 Point socket, 7/16"	1	42	917.1566	1/4" 12 Point socket deep 7/32"	1

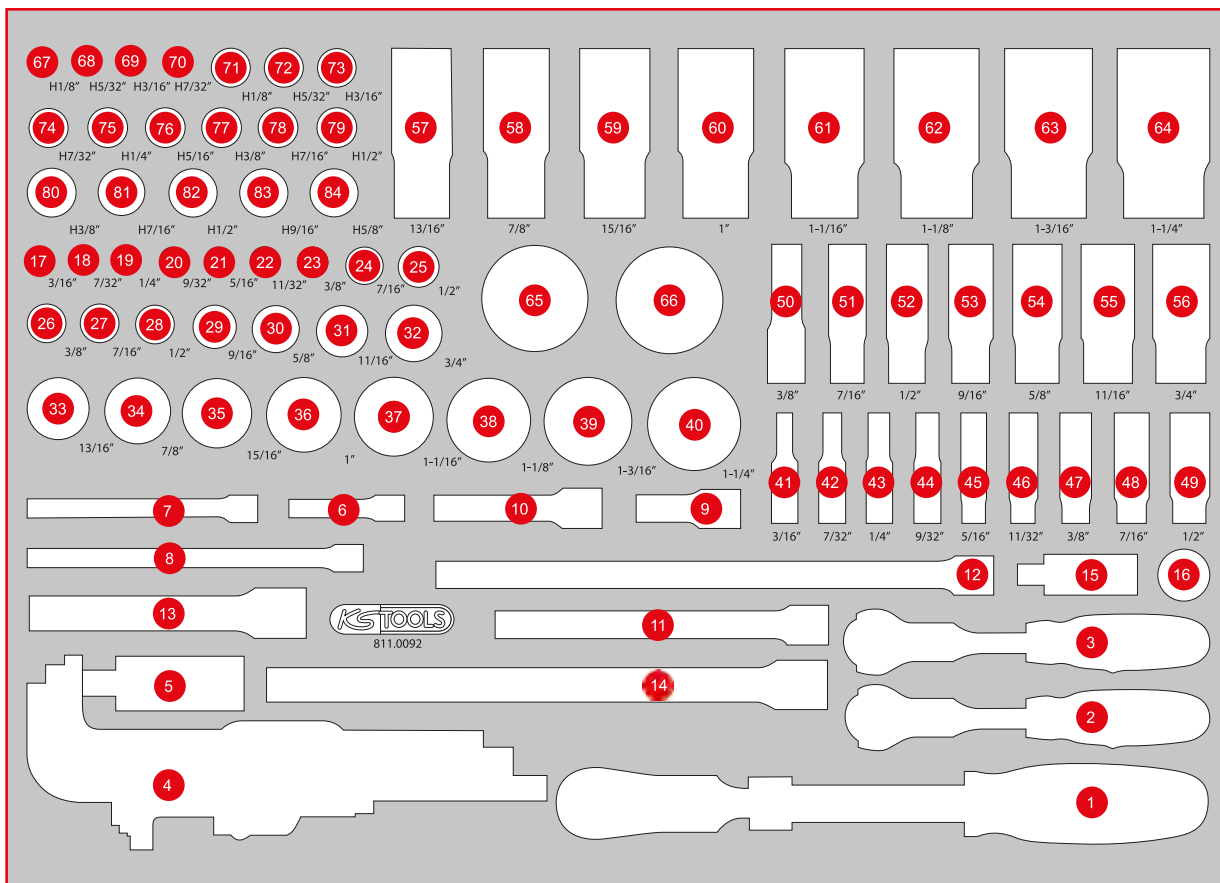

Pos.	Code	Description	pcs	Pos.	Code	Description	pcs	Pos.	Code	Description	pcs
43	917.1567	1/4" 12 Point socket deep 1/4"	1	58	917.1283	1/2" 12 Point socket, deep, 7/8"	1	73	917.3963	3/8" Bit socket hexagon, 3/16"	1
44	917.1568	1/4" 12 Point socket deep 9/32"	1	59	917.1284	1/2" 12 Point socket, deep, 15/16"	1	74	917.3968	3/8" Bit socket hexagon, 7/32"	1
45	917.1569	1/4" 12 Point socket deep 5/16"	1	60	917.1289	1/2" 12 Point socket, deep, 1"	1	75	917.3964	3/8" Bit socket hexagon, 1/4"	1
46	917.1570	1/4" 12 Point socket deep 11/32"	1	61	917.5348	1/2" 12 Point socket, deep, 1.1/16"	1	76	917.3965	3/8" Bit socket hexagon, 5/16"	1
47	917.1571	1/4" 12 Point socket deep 3/8"	1	62	917.5349	1/2" 12 Point socket, deep, 1.1/8"	1	77	917.3966	3/8" Bit socket hexagon, 3/8"	1
48	917.1572	1/4" 12 Point socket deep 7/16"	1	63	917.5353	1/2" 12 Point socket, deep, 1.3/16"	1	78	917.3993	3/8" Bit socket hexagon, 7/16"	1
49	917.1573	1/4" 12 Point socket deep 1/2"	1	64	917.5351	1/2" 12 Point socket, deep, 1.1/4"	1	79	917.3994	3/8" Bit socket hexagon, 1/2"	1
50	917.3983	3/8" 12 Point socket, deep, 3/8"	1	65	914.3810	Mini hand reversible ratchet, 3/8", 72 teeth	1	80	917.1321	1/2" Bit socket hexagon, short, 3/8"	1
51	917.3984	3/8" 12 Point socket, deep, 7/16"	1	66	914.1410	Mini hand reversible ratchet, 1/4", 72 teeth	1	81	911.5387	1/2" Bit socket hexagon, short, 7/16"	1
52	917.3985	3/8" 12 Point socket, deep, 1/2"	1	67	917.1440	1/4" Bit socket hexagon, 1/8"	1	82	917.1322	1/2" Bit socket hexagon, short, 1/2"	1
53	917.3986	3/8" 12 Point socket, deep, 9/16"	1	68	917.1441	1/4" Bit socket hexagon, 5/32"	1	83	917.1323	1/2" Bit socket hexagon, short, 9/16"	1
54	917.3987	3/8" 12 Point socket, deep, 5/8"	1	69	917.1442	1/4" Bit socket hexagon, 3/16"	1	84	917.1324	1/2" Bit socket hexagon, short, 5/8"	1
55	917.3988	3/8" 12 Point socket, deep, 11/16"	1	70	917.1443	1/4" Bit socket hexagon, 7/32"	1				
56	917.3989	3/8" 12 Point socket, deep, 3/4"	1	71	917.3967	3/8" Bit socket hexagon, 1/8"	1				
57	917.1282	1/2" 12 Point socket, deep, 13/16"	1	72	917.3962	3/8" Bit socket hexagon, 5/32"	1				

P 10

P 15

P 20

P 25

P 30

P 35

P 40

P 45

M

L

XL

S

Individual parts

Accessories

811.0099

M 1/4" + 3/8" + 1/2" Socket spanner set



229, ^{EUR}-

1 PCS
99

568 x 398

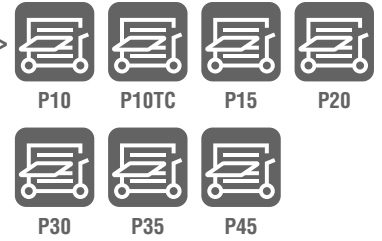

Pos.	Code	Description	pcs	Pos.	Code	Description	pcs	Pos.	Code	Description	pcs
1	917.1316	1/2" Bit socket hexagon, short, 3/16"	1	16	917.3965	3/8" Bit socket hexagon, 5/16"	1	31	917.1386	1/2" 12 Point socket, 1.3/16"	1
2	917.1318	1/2" Bit socket hexagon, short, 1/4"	1	17	917.3966	3/8" Bit socket hexagon, 3/8"	1	32	917.1387	1/2" 12 Point socket, 1.1/4"	1
3	917.1319	1/2" Bit socket hexagon, short, 9/32"	1	18	917.3993	3/8" Bit socket hexagon, 7/16"	1	33	917.1370	1/2" 12 Point socket, 3/8"	1
4	917.1320	1/2" Bit socket hexagon, short, 5/16"	1	19	917.3994	3/8" Bit socket hexagon, 1/2"	1	34	917.1372	1/2" 12 Point socket, 7/16"	1
5	911.5386	1/2" Bit socket hexagon, short, 11/32"	1	20	917.1440	1/4" Bit socket hexagon, 1/8"	1	35	917.1373	1/2" 12 Point socket, 1/2"	1
6	917.1321	1/2" Bit socket hexagon, short, 3/8"	1	21	917.1441	1/4" Bit socket hexagon, 5/32"	1	36	917.1374	1/2" 12 Point socket, 9/16"	1
7	911.5387	1/2" Bit socket hexagon, short, 7/16"	1	22	917.1442	1/4" Bit socket hexagon, 3/16"	1	37	917.1376	1/2" 12 Point socket, 5/8"	1
8	917.1322	1/2" Bit socket hexagon, short, 1/2"	1	23	917.1443	1/4" Bit socket hexagon, 7/32"	1	38	917.1377	1/2" 12 Point socket, 11/16"	1
9	917.1323	1/2" Bit socket hexagon, short, 9/16"	1	24	917.1444	1/4" Bit socket hexagon, 1/4"	1	39	917.1378	1/2" 12 Point socket, 3/4"	1
10	917.1324	1/2" Bit socket hexagon, short, 5/8"	1	25	917.1501	1/4" Bit socket hexagon, 5/16"	1	40	917.1380	1/2" 12 Point socket, 13/16"	1
11	917.3967	3/8" Bit socket hexagon, 1/8"	1	26	917.1502	1/4" Bit socket hexagon, 3/8"	1	41	917.1381	1/2" 12 Point socket, 7/8"	1
12	917.3962	3/8" Bit socket hexagon, 5/32"	1	27	917.1382	1/2" 12 Point socket, 15/16"	1	42	917.3851	3/8" 12 Point socket, 3/8"	1
13	917.3963	3/8" Bit socket hexagon, 3/16"	1	28	917.1383	1/2" 12 Point socket, 1"	1	43	917.3852	3/8" 12 Point socket, 7/16"	1
14	917.3968	3/8" Bit socket hexagon, 7/32"	1	29	917.1384	1/2" 12 Point socket, 1.1/16"	1	44	911.4000	3/8" 12 Point socket, 1/2"	1
15	917.3964	3/8" Bit socket hexagon, 1/4"	1	30	917.1385	1/2" 12 Point socket, 1.1/8"	1	45	911.4001	3/8" 12 Point socket, 9/16"	1

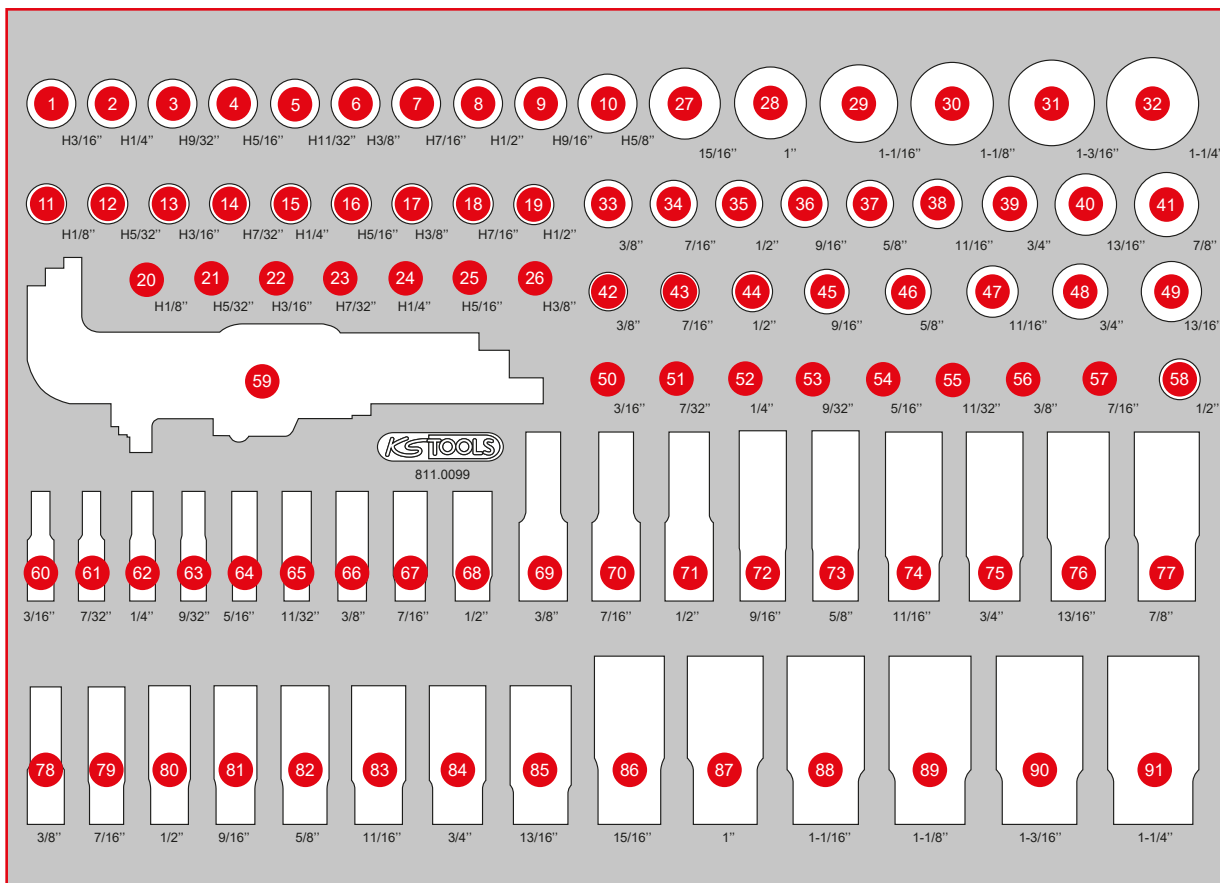

Pos.	Code	Description	pcs	Pos.	Code	Description	pcs	Pos.	Code	Description	pcs
46	911.4003	3/8" 12 Point socket, 5/8"	1	61	917.1566	1/4" 12 Point socket deep 7/32"	1	77	917.1283	1/2" 12 Point socket, deep, 7/8"	1
47	911.4004	3/8" 12 Point socket, 11/16"	1	62	917.1567	1/4" 12 Point socket deep 1/4"	1	78	917.3983	3/8" 12 Point socket, deep, 3/8"	1
48	911.4005	3/8" 12 Point socket, 3/4"	1	63	917.1568	1/4" 12 Point socket deep 9/32"	1	79	917.3984	3/8" 12 Point socket, deep, 7/16"	1
49	917.3854	3/8" 12 Point socket, 13/16"	1	64	917.1569	1/4" 12 Point socket deep 5/16"	1	80	917.3985	3/8" 12 Point socket, deep, 1/2"	1
50	917.1474	1/4" 12 Point socket, 3/16"	1	65	917.1570	1/4" 12 Point socket deep 11/32"	1	81	917.3986	3/8" 12 Point socket, deep, 9/16"	1
51	917.1475	1/4" 12 Point socket, 7/32"	1	66	917.1571	1/4" 12 Point socket deep 3/8"	1	82	917.3987	3/8" 12 Point socket, deep, 5/8"	1
52	917.1476	1/4" 12 Point socket, 1/4"	1	67	917.1572	1/4" 12 Point socket deep 7/16"	1	83	917.3988	3/8" 12 Point socket, deep, 11/16"	1
53	917.1477	1/4" 12 Point socket, 9/32"	1	68	917.1573	1/4" 12 Point socket deep 1/2"	1	84	917.3989	3/8" 12 Point socket, deep, 3/4"	1
54	917.1478	1/4" 12 Point socket, 5/16"	1	69	917.1287	1/2" 12 Point socket, deep, 3/8"	1	85	917.3990	3/8" 12 Point socket, deep, 13/16"	1
55	917.1479	1/4" 12 Point socket, 11/32"	1	70	917.1288	1/2" 12 Point socket, deep, 7/16"	1	86	917.1284	1/2" 12 Point socket, deep, 15/16"	1
56	917.1480	1/4" 12 Point socket, 3/8"	1	71	917.1277	1/2" 12 Point socket, deep, 1/2"	1	87	917.1289	1/2" 12 Point socket, deep, 1"	1
57	917.1481	1/4" 12 Point socket, 7/16"	1	72	917.1278	1/2" 12 Point socket, deep, 9/16"	1	88	917.5348	1/2" 12 Point socket, deep, 1.1/16"	1
58	917.1482	1/4" 12 Point socket, 1/2"	1	73	917.1279	1/2" 12 Point socket, deep, 5/8"	1	89	917.5349	1/2" 12 Point socket, deep, 1.1/8"	1
59	151.4520	Ball ended hexagon key wrench set, extra long, 9 pcs, imperial	9	74	917.1280	1/2" 12 Point socket, deep, 11/16"	1	90	917.5353	1/2" 12 Point socket, deep, 1.3/16"	1
60	917.1565	1/4" 12 Point socket deep 3/16"	1	75	917.1281	1/2" 12 Point socket, deep, 3/4"	1	91	917.5351	1/2" 12 Point socket, deep, 1.1/4"	1
				76	917.1282	1/2" 12 Point socket, deep, 13/16"	1				

P 10
P 15
P 20
P 25
P 30
P 35
P 40
P 45
Individual parts S XL L M
Accessories

811.0032

M 3/4" Socket spanner set

449, ^{EUR}—



Pos.	Code	Description	pcs
1	911.3400	3/4" Reversible ratchet, 72 teeth	1
2	911.3405	3/4" Sliding T-handle, 450mm	1
3	911.3404	3/4" Extensions, 400 mm	1
4	911.3470	3/4" Flexi head drive handle, 500 mm	1
5	911.3518	3/4" 12 Point socket, short, 19 mm	1
6	911.3525	3/4" 12 Point socket, short, 21 mm	1
7	911.3528	3/4" 12 Point socket, short, 22 mm	1
8	911.3533	3/4" 12 Point socket, short, 24 mm	1
9	911.3537	3/4" 12 Point socket, short, 27 mm	1
10	911.3542	3/4" 12 Point socket, short, 30 mm	1
11	911.3543	3/4" 12 Point socket, short, 32 mm	1
12	911.3544	3/4" 12 Point socket, short, 33 mm	1
13	911.3545	3/4" 12 Point socket, short, 34 mm	1
14	911.3548	3/4" 12 Point socket, short, 36 mm	1
15	911.3549	3/4" 12 Point socket, short, 38 mm	1
16	911.3557	3/4" 12 Point socket, short, 41 mm	1
17	911.3598	3/4" 12 Point socket, short, 46 mm	1
18	911.3599	3/4" 12 Point socket, short, 50 mm	1
19	911.3522	3/4" 12 Point socket, short, 7/8"	1
20	911.3523	3/4" 12 Point socket, short, 15/16"	1
21	911.3524	3/4" 12 Point socket, short, 1"	1
22	911.3526	3/4" 12 Point socket, short, 1.1/16"	1
23	911.3527	3/4" 12 Point socket, short, 1.1/8"	1
24	911.3529	3/4" 12 Point socket, short, 1.3/16"	1
25	911.3530	3/4" 12 Point socket, short, 1.1/4"	1
26	911.3532	3/4" 12 Point socket, short, 1.5/16"	1
27	911.3535	3/4" 12 Point socket, short, 1.3/8"	1
28	911.3536	3/4" 12 Point socket, short, 1.7/16"	1
29	911.3538	3/4" 12 Point socket, short, 1.1/2"	1
30	911.3541	3/4" 12 Point socket, short, 1.5/8"	1
31	911.3546	3/4" 12 Point socket, short, 1.3/4"	1
32	911.3457	3/4" 12 Point socket, short, 1.7/8"	1

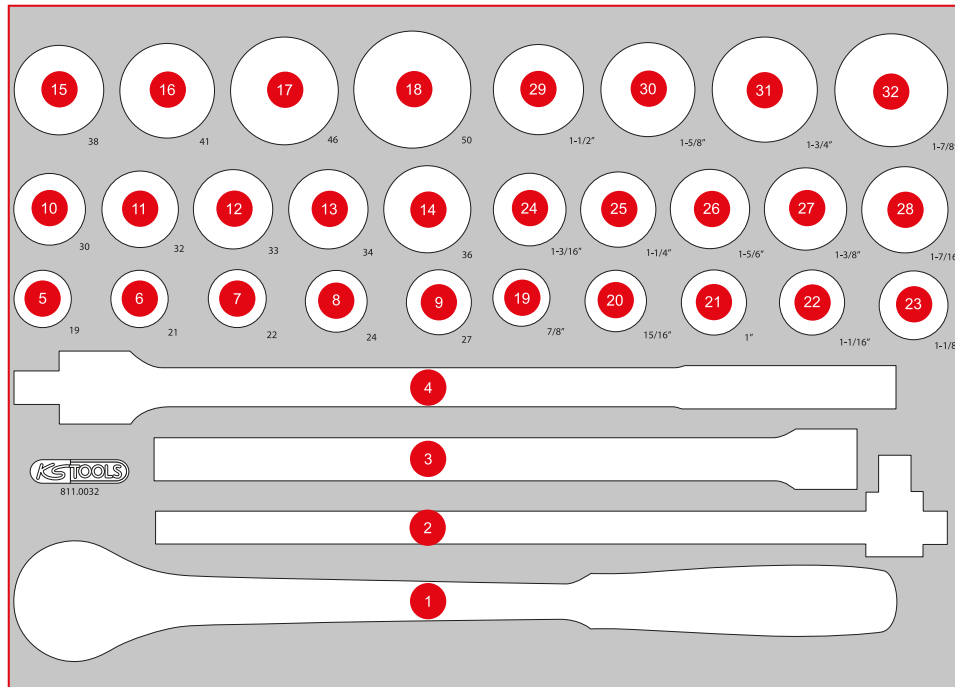



P 10

P 15

P 20

P 25

P 30

P 35

P 40

P 45

M

L

S

XL

Individual parts

Accessories

811.1055

M Spanner and impact socket set



319,^{EUR}-

55

568 x 398

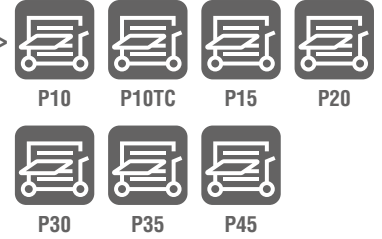

Pos.	Code	Description	pcs
1	515.1113	1/2" Hexagon impact socket, deep, 13mm	1
2	515.1114	1/2" Hexagon impact socket, deep, 14 mm	1
3	515.1115	1/2" Hexagon impact socket, deep, 15 mm	1
4	515.1116	1/2" Hexagon impact socket, deep, 16 mm	1
5	515.1117	1/2" Hexagon impact socket, deep, 17 mm	1
6	515.1118	1/2" Hexagon impact socket, deep, 18 mm	1
7	515.1119	1/2" Hexagon impact socket, deep, 19 mm	1
8	515.1121	1/2" Hexagon impact socket, deep, 21 mm	1

Pos.	Code	Description	pcs
9	515.1122	1/2" Hexagon impact socket, deep, 22 mm	1
10	515.1124	1/2" Hexagon impact socket, deep, 24 mm	1
11	515.1127	1/2" Hexagon impact socket, deep, 27 mm	1
12	515.1130	1/2" Hexagon impact socket, deep, 30 mm	1
13	515.1132	1/2" Hexagon impact socket, deep, 32 mm	1
14	518.0529	Open double ring spanner, with double joint, 12x13 mm	1
15	518.0528	Open double ring spanner, with double joint, 10x11 mm	1

Pos.	Code	Description	pcs
16	518.0527	Open-double-ring-spanner 8x9	1
17	518.0012	CHROMEplus Combination spanner, stubby, 12mm	1
18	518.0011	CHROMEplus Combination spanner, stubby, 11 mm	1
19	518.0010	CHROMEplus Combination spanner, stubby, 10 mm	1
20	518.0008	CHROMEplus Combination spanner, stubby, 9 mm	1

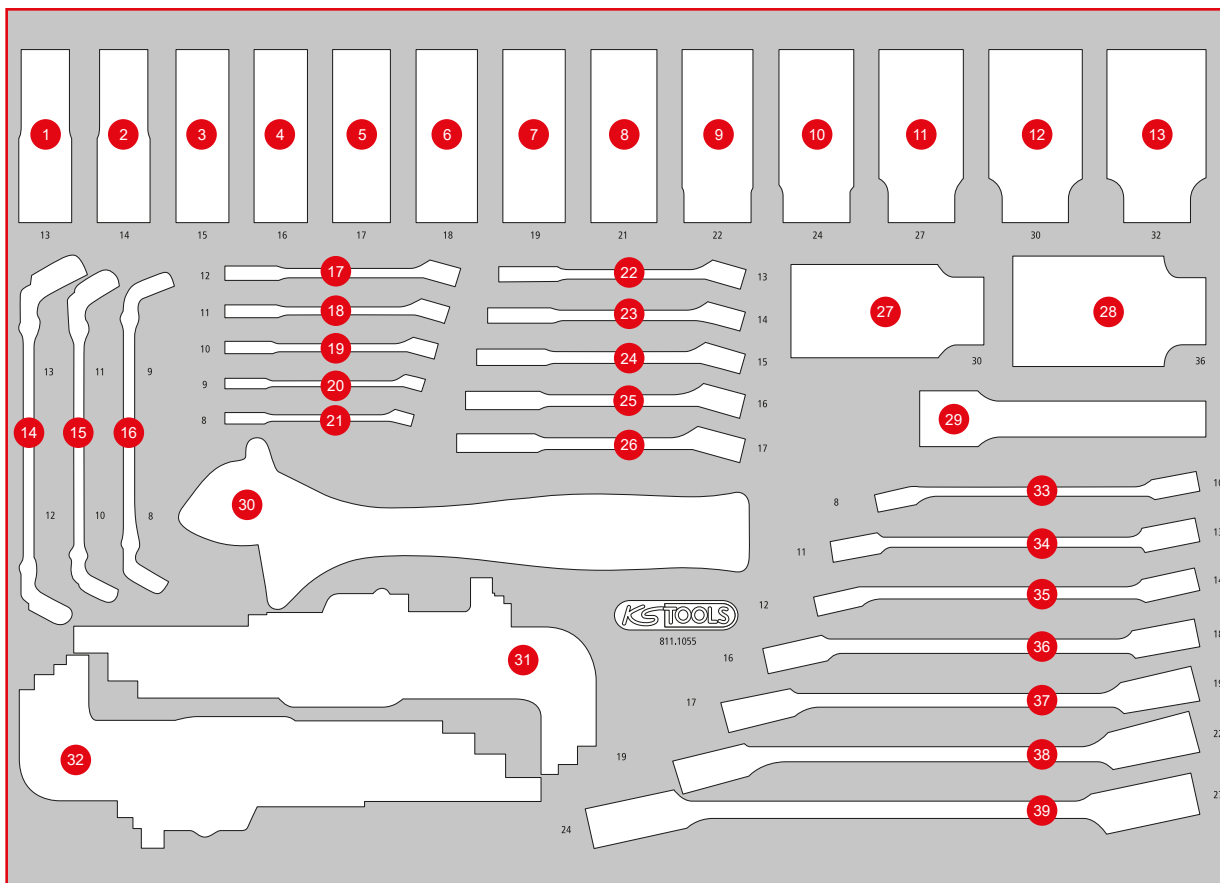

Pos.	Code	Description	pcs	Pos.	Code	Description	pcs	Pos.	Code	Description	pcs
21	518.0007	CHROMEplus Combination spanner, stubby, 8 mm	1	26	518.0017	CHROMEplus Combination spanner, stubby, 17 mm	1	32	151.5210	Ball head Torx angled socket wrench set, extra long, 9 pcs	9
22	518.0013	CHROMEplus Combination spanner, stubby, 13 mm	1	27	150.1705	Special drive shaft impact socket, 1/2", 30 mm	1	33	517.0252	Open double ring spanner, offset, 8 x 10mm	1
23	518.0014	CHROMEplus Combination spanner, stubby, 14 mm	1	28	150.1707	Special drive shaft impact socket, 1/2", 36 mm	1	34	517.9244	Open double ring spanner, offset, 11 x 13 mm	1
24	518.0015	CHROMEplus Combination spanner, stubby, 15 mm	1	29	515.1135	1/2" Impact extension, 125 mm	1	35	517.0258	Open double ring spanner, offset, 12 x 14 mm	1
25	518.0016	CHROMEplus Combination spanner, stubby, 16 mm	1	30	577.0251	Adjustable spanner with dual component comfort grip handle, 28 mm	1	36	517.0263	Open double ring spanner, offset, 16 x 18 mm	1
				31	151.4420	Ball ended hexagon key wrench set, extra long, 9 pcs	9	37	517.0264	Open double ring spanner, offset, 17 x 19 mm	1
								38	517.0266	Open double ring spanner, offset, 19 x 22 mm	1
								39	517.0268	Open double ring spanner, offset, 24 x 27 mm	1

P 10

P 15

P 20

P 25

P 30

P 35

P 40

P 45

M

L

S

XL

Individual parts

Accessories

811.0073

M 3/8" + 1/2" socket spanner set



309, — ^{EUR}

73

568 x 398

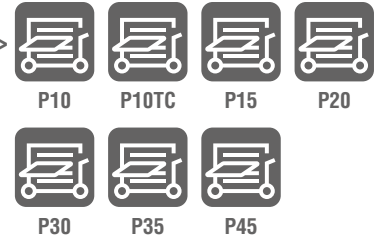

Pos.	Code	Description	pcs	Pos.	Code	Description	pcs	Pos.	Code	Description	pcs
1	515.1508	3/8" Hexagon impact socket, short, 8 mm	1	14	515.1012	1/2" Hexagon impact socket short, 12 mm	1	27	515.1025	1/2" Hexagon impact socket short, 25 mm	1
2	515.1510	3/8" Hexagon impact socket, short, 10 mm	1	15	515.1013	1/2" Hexagon impact socket short, 13 mm	1	28	515.1026	1/2" Hexagon impact socket short, 26 mm	1
3	515.1511	3/8" Hexagon impact socket, short, 11 mm	1	16	515.1014	1/2" Hexagon impact socket short, 14 mm	1	29	515.1027	1/2" Hexagon impact socket short, 27 mm	1
4	515.1512	3/8" Hexagon impact socket, short, 12 mm	1	17	515.1015	1/2" Hexagon impact socket short, 15 mm	1	30	515.1028	1/2" Hexagon impact socket short, 28 mm	1
5	515.1513	3/8" Hexagon impact socket, short, 13 mm	1	18	515.1016	1/2" Hexagon impact socket short, 16 mm	1	31	515.1029	1/2" Hexagon impact socket short, 29 mm	1
6	515.1514	3/8" Hexagon impact socket, short, 14 mm	1	19	515.1017	1/2" Hexagon impact socket short, 17 mm	1	32	515.1030	1/2" Hexagon impact socket short, 30 mm	1
7	515.1515	3/8" Hexagon impact socket, short, 15 mm	1	20	515.1018	1/2" Hexagon impact socket short, 18 mm	1	33	515.1032	1/2" Hexagon impact socket short, 32 mm	1
8	515.1516	3/8" Hexagon impact socket, short, 16 mm	1	21	515.1019	1/2" Hexagon impact socket short, 19 mm	1	34	515.1144	1/2" Impact adaptor, 1/2" F x 3/4" M	1
9	515.1517	3/8" Hexagon impact socket, short, 17 mm	1	22	515.1020	1/2" Hexagon impact socket short, 20 mm	1	35	515.1143	1/2" Impact adaptor, 1/2" F x 3/8" M	1
10	515.1519	3/8" Hexagon impact socket, short, 19 mm	1	23	515.1021	1/2" Hexagon impact socket short, 21 mm	1	36	515.1532	Impact adaptor, F 3/8" x 1/2" M	1
11	515.1008	1/2" Hexagon impact socket short, 8 mm	1	24	515.1022	1/2" Hexagon impact socket short, 22 mm	1	37	515.1531	Impact adaptor, F 3/8" x 1/4" M	1
12	515.1010	1/2" Hexagon impact socket short, 10 mm	1	25	515.1023	1/2" Hexagon impact socket short, 23 mm	1	38	515.1599	Impact bit adaptor socket, 3/8" x 1/4"	1
13	515.1011	1/2" Hexagon impact socket short, 11 mm	1	26	515.1024	1/2" Hexagon impact socket short, 24 mm	1	39	515.1135	1/2" Impact extension, 125 mm	1

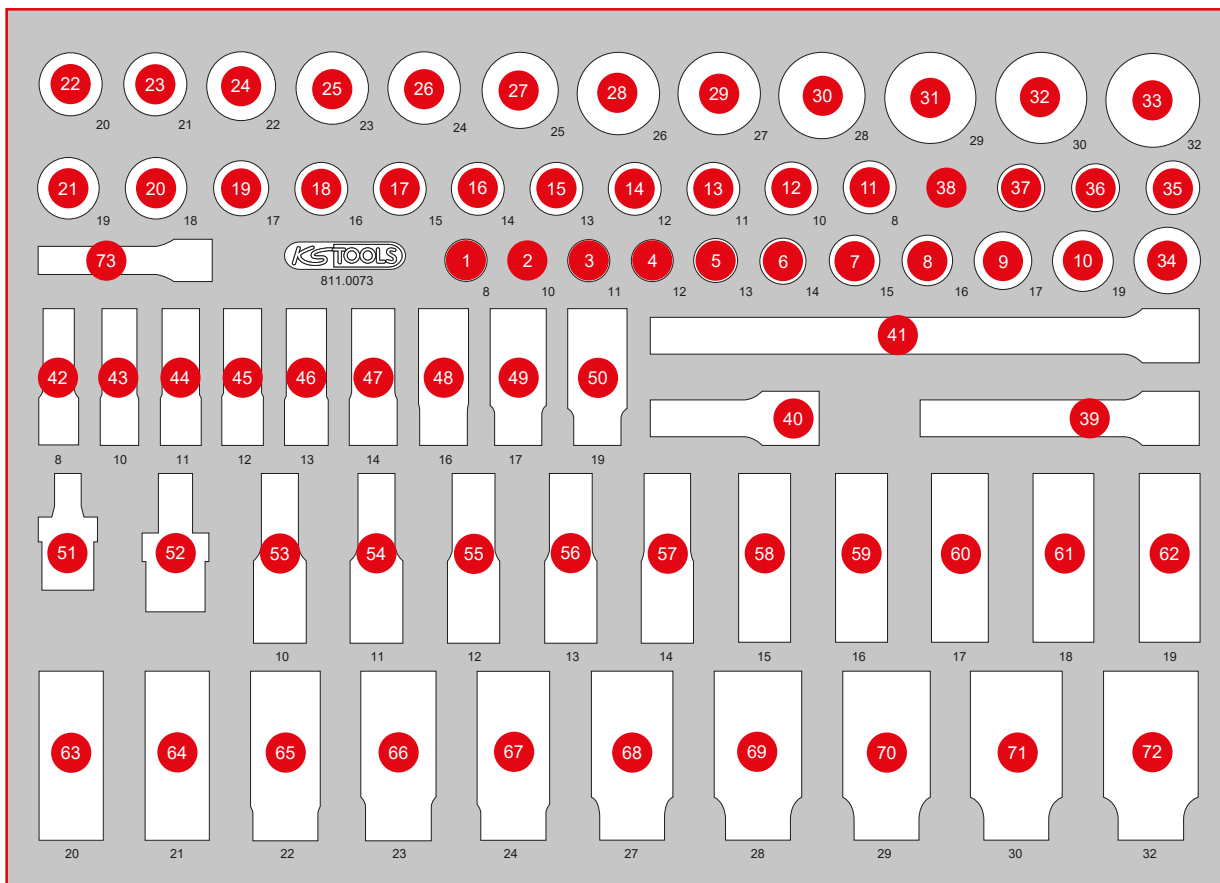

Pos.	Code	Description	pcs	Pos.	Code	Description	pcs	Pos.	Code	Description	pcs
40	515.1134	1/2" Impact extension, 75 mm	1	53	515.1110	1/2" Hexagon impact socket, deep, 10 mm	1	66	515.1123	1/2" Hexagon impact socket, deep, 23 mm	1
41	515.1136	1/2" Impact extension, 250 mm	1	54	515.1111	1/2" Hexagon impact socket, deep, 11 mm	1	67	515.1124	1/2" Hexagon impact socket, deep, 24 mm	1
42	515.1608	3/8" Hexagon impact socket, deep, 8 mm	1	55	515.1112	1/2" Hexagon impact socket, deep, 12 mm	1	68	515.1127	1/2" Hexagon impact socket, deep, 27 mm	1
43	515.1610	3/8" Hexagon impact socket, deep, 10 mm	1	56	515.1113	1/2" Hexagon impact socket, deep, 13 mm	1	69	515.1128	1/2" Hexagon impact socket, deep, 28 mm	1
44	515.1611	3/8" Hexagon impact socket, deep, 11 mm	1	57	515.1114	1/2" Hexagon impact socket, deep, 14 mm	1	70	515.1129	1/2" Hexagon impact socket, deep, 29 mm	1
45	515.1612	3/8" Hexagon impact socket, deep, 12 mm	1	58	515.1115	1/2" Hexagon impact socket, deep, 15 mm	1	71	515.1130	1/2" Hexagon impact socket, deep, 30 mm	1
46	515.1613	3/8" Hexagon impact socket, deep, 13 mm	1	59	515.1116	1/2" Hexagon impact socket, deep, 16 mm	1	72	515.1132	1/2" Hexagon impact socket, deep, 32 mm	1
47	515.1614	3/8" Hexagon impact socket, deep, 14 mm	1	60	515.1117	1/2" Hexagon impact socket, deep, 17 mm	1	73	515.1534	3/8" Impact extension, 75 mm	1
48	515.1616	3/8" Hexagon impact socket, deep, 16 mm	1	61	515.1118	1/2" Hexagon impact socket, deep, 18 mm	1				
49	515.1617	3/8" Hexagon impact socket, deep, 17 mm	1	62	515.1119	1/2" Hexagon impact socket, deep, 19 mm	1				
50	515.1619	3/8" Hexagon impact socket, deep, 19 mm	1	63	515.1120	1/2" Hexagon impact socket, deep, 20 mm	1				
51	515.1533	3/8" Impact universal ball joint	1	64	515.1121	1/2" Hexagon impact socket, deep, 21 mm	1				
52	515.1133	1/2" Impact universal ball joint	1	65	515.1122	1/2" Hexagon impact socket, deep, 22 mm	1				

P 10

P 15

P 20

P 25

P 30

P 35

P 40

P 45

M

L

S

XL

Individual parts

Accessories

811.0039

M 1/2" impact socket set

299, ^{EUR}-



568 x 398

P10

P10TC

P15

P20

P30

P35

P45



Pos.	Code	Description	pcs
1	515.1128	1/2" Hexagon impact socket, deep, 28 mm	1
2	515.1129	1/2" Hexagon impact socket, deep, 29 mm	1
3	515.1130	1/2" Hexagon impact socket, deep, 30 mm	1
4	515.1132	1/2" Hexagon impact socket, deep, 32 mm	1
5	515.1139	1/2" Hexagon impact socket, deep, 33 mm	1
6	515.1147	1/2" Hexagon impact socket, deep, 34 mm	1
7	515.1148	1/2" Hexagon impact socket, deep, 35 mm	1
8	515.1149	1/2" Hexagon impact socket, deep, 36 mm	1
9	515.1151	1/2" Hexagon impact socket, deep, 38 mm	1
10	515.1116	1/2" Hexagon impact socket, deep, 16 mm	1
11	515.1117	1/2" Hexagon impact socket, deep, 17 mm	1
12	515.1118	1/2" Hexagon impact socket, deep, 18 mm	1
13	515.1119	1/2" Hexagon impact socket, deep, 19 mm	1
14	515.1120	1/2" Hexagon impact socket, deep, 20 mm	1
15	515.1121	1/2" Hexagon impact socket, deep, 21 mm	1
16	515.1122	1/2" Hexagon impact socket, deep, 22 mm	1
17	515.1123	1/2" Hexagon impact socket, deep, 23 mm	1
18	515.1124	1/2" Hexagon impact socket, deep, 24 mm	1
19	515.1125	1/2" Hexagon impact socket, deep, 25 mm	1
20	515.1126	1/2" Hexagon impact socket, deep, 26 mm	1
21	515.1127	1/2" Hexagon impact socket, deep, 27 mm	1
22	911.0911	1/2" Impact bit socket, hexagon, short, 19 mm	1
23	911.0909	1/2" Impact bit socket, hexagon, short, 17 mm	1
24	911.0908	1/2" Impact bit socket, hexagon, short, 14 mm	1
25	515.2055	Special aluminium rims special profile impact socket for Mercedes, long, 17 mm	1
26	515.0991	SlimPOWER 1/2" Alloy rim impact socket, 15 mm	1
27	515.0992	SlimPOWER 1/2" Alloy rim impact socket, 17mm	1
28	515.0993	SlimPOWER 1/2" Alloy rim impact socket, 19 mm	1
29	515.0994	SlimPOWER 1/2" Alloy rim impact socket, 21 mm	1
30	515.0995	SlimPOWER 1/2" Alloy rim impact socket, 22 mm	1
31	515.1110	1/2" Hexagon impact socket, deep, 10 mm	1
32	515.1111	1/2" Hexagon impact socket, deep, 11 mm	1
33	515.1112	1/2" Hexagon impact socket, deep, 12 mm	1
34	515.1113	1/2" Hexagon impact socket, deep, 13 mm	1
35	515.1114	1/2" Hexagon impact socket, deep, 14 mm	1
36	515.1115	1/2" Hexagon impact socket, deep, 15 mm	1
37	515.1134	1/2" Impact extension, 75 mm	1
38	515.1135	1/2" Impact extension, 125 mm	1
39	515.1136	1/2" Impact extension, 250 mm	1

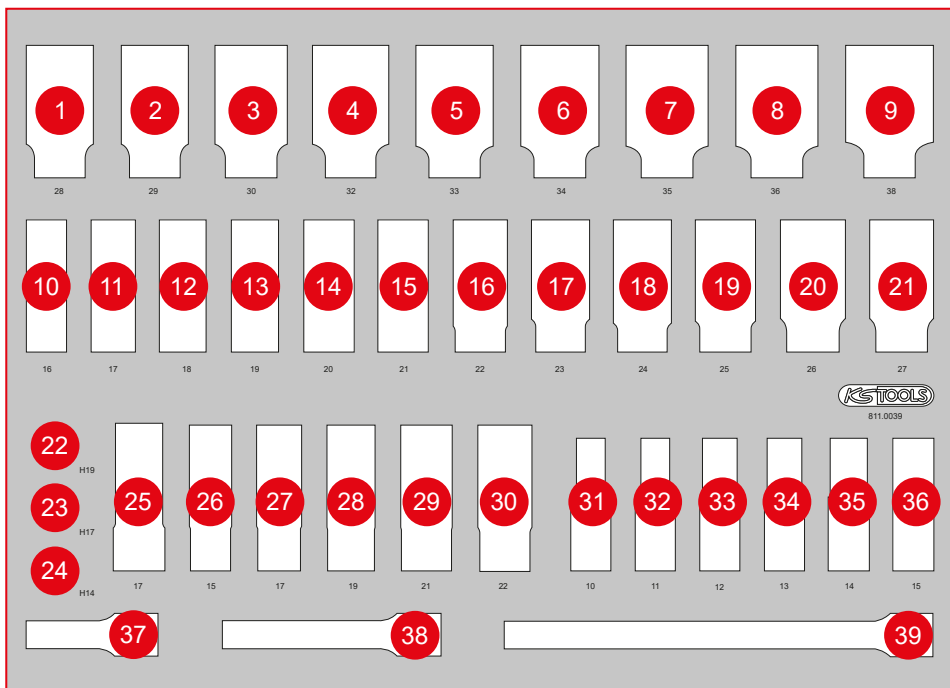

811.1033

M 3/4 " Impact socket set

499,- EUR



568 x 398

P10

P10TC

P15

P20

P30

P35

P45



Pos.	Code	Description	pcs
1	515.1319	3/4" Hexagon impact socket, short, 19 mm	1
2	515.1321	3/4" Hexagon impact socket, short, 21 mm	1
3	515.1322	3/4" Hexagon impact socket, short, 22 mm	1
4	515.1323	3/4" Hexagon impact socket, short, 23 mm	1
5	515.1324	3/4" Hexagon impact socket, short, 24 mm	1
6	515.1327	3/4" Hexagon impact socket, short, 27 mm	1
7	515.1328	3/4" Hexagon impact socket, short, 28 mm	1
8	515.1330	3/4" Hexagon impact socket, short, 30 mm	1
9	515.1332	3/4" Hexagon impact socket, short, 32 mm	1
10	515.1333	3/4" Hexagon impact socket, short, 33 mm	1
11	515.1334	3/4" Hexagon impact socket, short, 34 mm	1
12	515.1336	3/4" Hexagon impact socket, short, 36 mm	1
13	515.1338	3/4" Hexagon impact socket, short, 38 mm	1
14	515.1341	3/4" Hexagon impact socket, short, 41 mm	1
15	515.1346	3/4" Hexagon impact socket, short, 46 mm	1
16	515.1419	3/4" Hexagon impact socket, deep, 19 mm	1
17	515.1421	3/4" Hexagon impact socket, deep, 21 mm	1
18	515.1422	3/4" Hexagon impact socket, deep, 22 mm	1
19	515.1423	3/4" Hexagon impact socket, deep, 23 mm	1
20	515.1424	3/4" Hexagon impact socket, deep, 24 mm	1
21	515.1427	3/4" Hexagon impact socket, deep, 27 mm	1
22	515.1430	3/4" Hexagon impact socket, deep, 30 mm	1
23	515.1432	3/4" Hexagon impact socket, deep, 32 mm	1
24	515.1433	3/4" Hexagon impact socket, deep, 33 mm	1
25	515.1434	3/4" Hexagon impact socket, deep, 34 mm	1
26	515.1436	3/4" Hexagon impact socket, deep, 36 mm	1
27	515.1438	3/4" Hexagon impact socket, deep, 38 mm	1
28	515.1441	3/4" Hexagon impact socket, deep, 41 mm	1
29	515.1446	3/4" Hexagon impact socket, deep, 46 mm	1
30	515.1374	3/4" Impact joint+suspension	1
31	515.1377	3/4" Impact extension, 150 mm	1
32	515.1372	Impact adaptor, F 3/4" x 1/2" M	1
33	515.1373	Impact adaptor, F 3/4" x 1" M	1

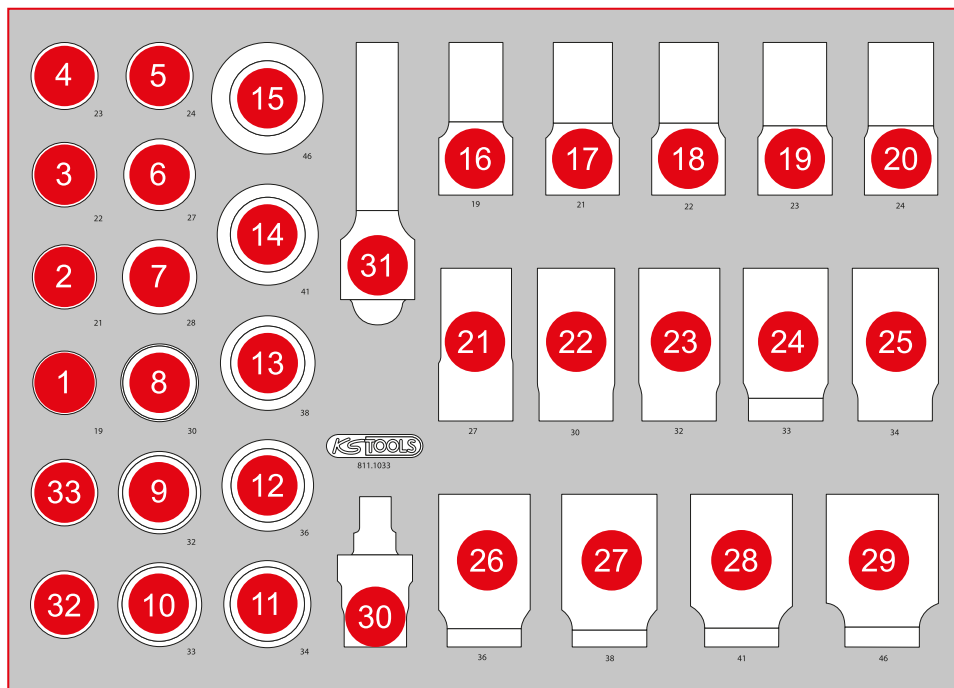

P 10

P 15

P 20

P 25

P 30

P 35

P 40

P 45

M

L

S

XL

Individual parts

Accessories

811.0024

M Screwdriver set

109, ^{EUR}—

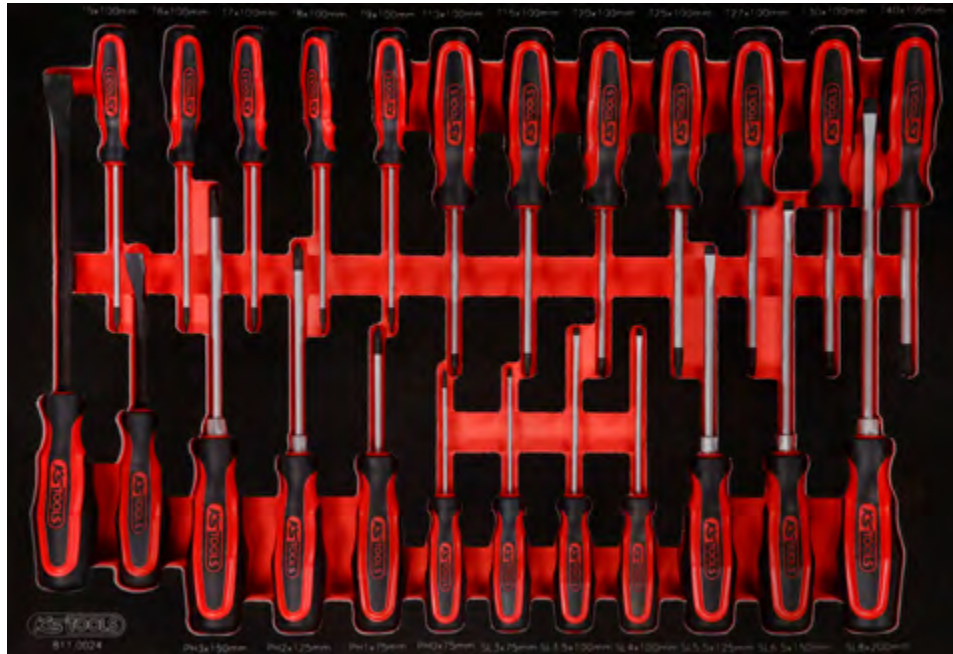

Pos.	Code	Description	pcs
1	911.8102	Pry bar, 15 x 185mm	1
2	911.8101	Pry bar, 11 x 115 mm	1
3	159.1133	ERGOTORQUEplus screwdriver, Torx, T5	1
4	159.1134	ERGOTORQUEplus screwdriver, Torx, T6	1
5	159.1135	ERGOTORQUEplus screwdriver, Torx, T7	1
6	159.1030	ERGOTORQUEplus screwdriver, Torx, T8	1
7	159.1031	ERGOTORQUEplus screwdriver, Torx, T9	1
8	159.1032	ERGOTORQUEplus screwdriver, Torx, T10	1
9	159.1033	ERGOTORQUEplus screwdriver, Torx, T15	1
10	159.1034	ERGOTORQUEplus screwdriver, Torx, T20	1
11	159.1035	ERGOTORQUEplus screwdriver, Torx, T25	1
12	159.1036	ERGOTORQUEplus screwdriver, Torx, T27	1
13	159.1037	ERGOTORQUEplus screwdriver, Torx, T30	1
14	159.1038	ERGOTORQUEplus screwdriver, Torx, T40	1
15	159.1024	ERGOTORQUEplus screwdriver, Torx, PH3, 265 mm	1
16	159.1022	ERGOTORQUEplus screwdriver, Torx, PH2, 230 mm	1
17	159.1020	ERGOTORQUEplus screwdriver, Torx, PH1, 180 mm	1
18	159.1027	ERGOTORQUEplus screwdriver, Torx, PH0, 155 mm	1
19	159.1002	ERGOTORQUEplus screwdriver for slotted screws, 3 mm, 155 mm	1
20	159.1112	ERGOTORQUEplus screwdriver for slotted screws, 3,5 mm, 180 mm	1
21	159.1004	ERGOTORQUEplus screwdriver for slotted screws, 4 mm, 180 mm	1
22	159.1006	ERGOTORQUEplus screwdriver for slotted screws, 5,5 mm, 230 mm	1
23	159.1009	ERGOTORQUEplus screwdriver for slotted screws, 6,5 mm, 255 mm	1
24	159.1011	ERGOTORQUEplus screwdriver for slotted screws, 8 mm, 315 mm	1

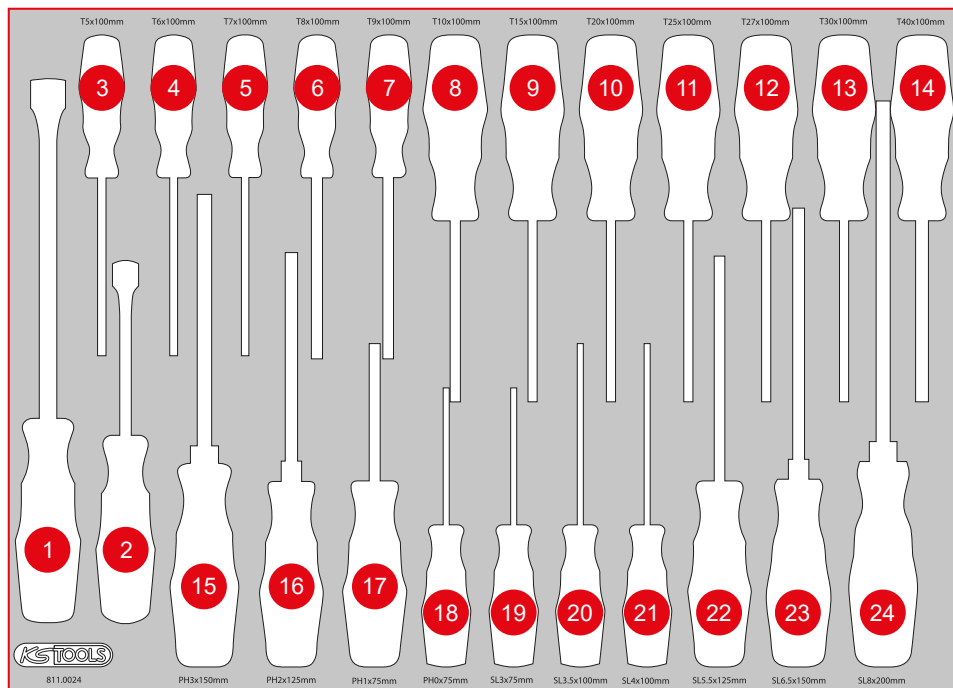

811.0027

M Screwdriver set

129,- EUR

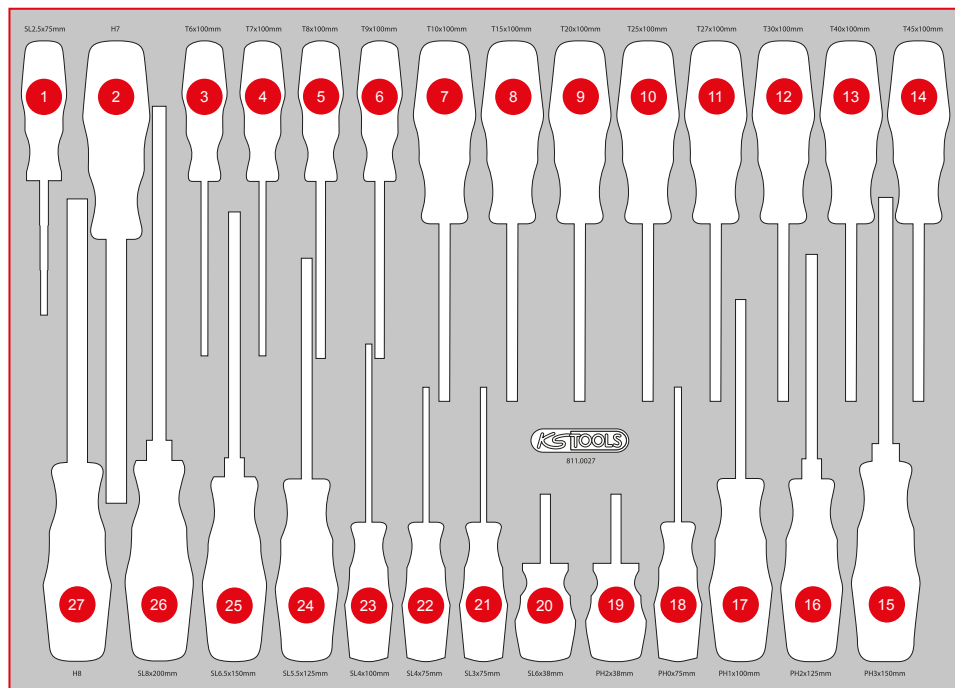
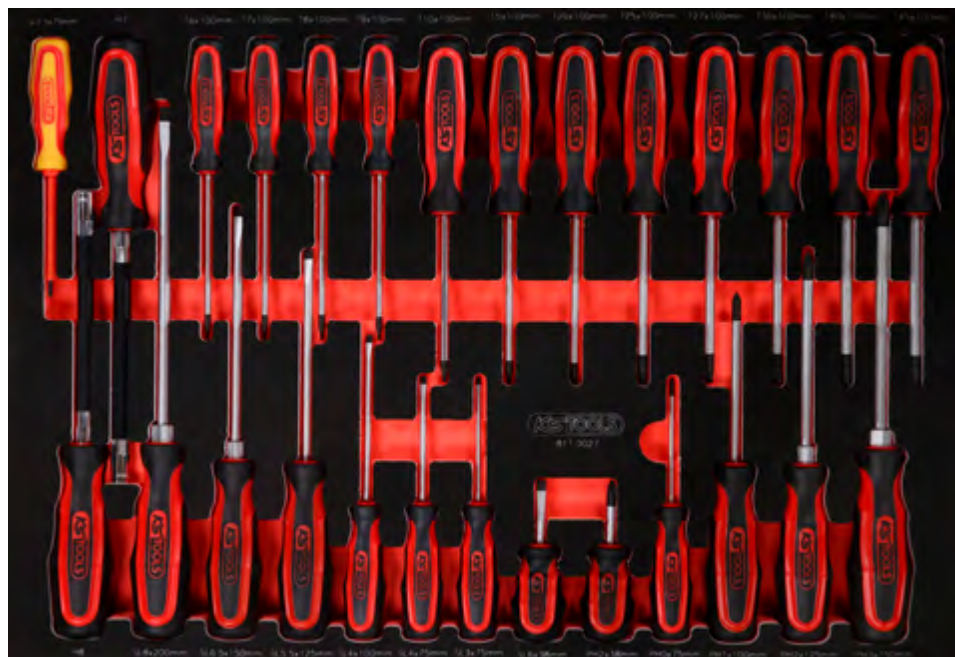

Pos.	Code	Description	pcs
1	117.0502	ERGOTORQUE VDE slot screwdriver, 2,5 mm	1
2	159.1127	ERGOTORQUEplus Socket screwdriver, 7 mm	1
3	159.1134	ERGOTORQUEplus screwdriver, Torx, T6	1
4	159.1135	ERGOTORQUEplus screwdriver, Torx, T7	1
5	159.1030	ERGOTORQUEplus screwdriver, Torx, T8	1
6	159.1031	ERGOTORQUEplus screwdriver, Torx, T9	1
7	159.1032	ERGOTORQUEplus screwdriver, Torx, T10	1
8	159.1033	ERGOTORQUEplus screwdriver, Torx, T15	1
9	159.1034	ERGOTORQUEplus screwdriver, Torx, T20	1
10	159.1035	ERGOTORQUEplus screwdriver, Torx, T25	1
11	159.1036	ERGOTORQUEplus screwdriver, Torx, T27	1
12	159.1037	ERGOTORQUEplus screwdriver, Torx, T30	1
13	159.1038	ERGOTORQUEplus screwdriver, Torx, T40	1
14	159.1136	ERGOTORQUEplus screwdriver, Torx, T45	1
15	159.2128	ERGOTORQUEplus Socket screwdriver, 8 mm	1
16	159.1011	ERGOTORQUEplus screwdriver for slotted screws, 8 mm, 315 mm	1
17	159.1009	ERGOTORQUEplus screwdriver for slotted screws, 6,5 mm, 255 mm	1
18	159.1006	ERGOTORQUEplus screwdriver for slotted screws, 5,5 mm, 230 mm	1
19	159.1004	ERGOTORQUEplus screwdriver for slotted screws, 4 mm, 180 mm	1
20	159.1003	ERGOTORQUEplus screwdriver for slotted screws, 4 mm, 155 mm	1
21	159.1002	ERGOTORQUEplus screwdriver for slotted screws, 3 mm, 155 mm	1
22	159.1001	ERGOTORQUEplus screwdriver for slotted screws, 6 mm, stubby	1
23	159.1026	ERGOTORQUEplus screwdriver for screws PH, PH2, stubby	1
24	159.1027	ERGOTORQUEplus screwdriver for screws PH, PH0, 155 mm	1
25	159.1029	ERGOTORQUEplus screwdriver for screws PH, PH1, 205 mm	1
26	159.1022	ERGOTORQUEplus screwdriver for screws PH, PH2, 230 mm	1
27	159.1024	ERGOTORQUEplus screwdriver for screws PH, PH3, 265 mm	1

P 10

P 15

P 20

P 25

P 30

P 35

P 40

P 45

M

L

S

XL

Individual parts

Accessories

811.1027

M Screwdriver set

129, ^{EUR}-

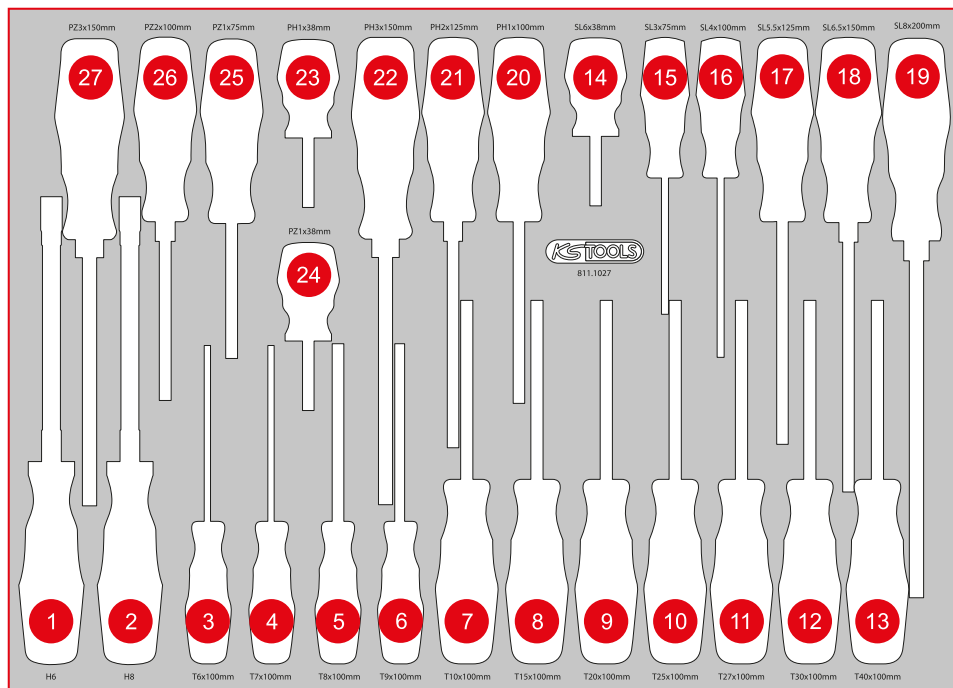

Pos.	Code	Description	pcs
1	159.1126	ERGOTORQUEplus Socket screwdriver, 6 mm	1
2	159.2128	ERGOTORQUEplus Socket screwdriver, 8 mm	1
3	159.1134	ERGOTORQUEplus screwdriver, Torx, T6	1
4	159.1135	ERGOTORQUEplus screwdriver, Torx, T7	1
5	159.1030	ERGOTORQUEplus screwdriver, Torx, T8	1
6	159.1031	ERGOTORQUEplus screwdriver, Torx, T9	1
7	159.1032	ERGOTORQUEplus screwdriver, Torx, T10	1
8	159.1033	ERGOTORQUEplus screwdriver, Torx, T15	1
9	159.1034	ERGOTORQUEplus screwdriver, Torx, T20	1
10	159.1035	ERGOTORQUEplus screwdriver, Torx, T25	1
11	159.1036	ERGOTORQUEplus screwdriver, Torx, T27	1
12	159.1037	ERGOTORQUEplus screwdriver, Torx, T30	1
13	159.1038	ERGOTORQUEplus screwdriver, Torx, T40	1
14	159.1001	ERGOTORQUEplus screwdriver for slotted screws, 6 mm, stubby	1
15	159.1002	ERGOTORQUEplus screwdriver for slotted screws, 3 mm, 155 mm	1
16	159.1004	ERGOTORQUEplus screwdriver for slotted screws, 4 mm, 180 mm	1
17	159.1006	ERGOTORQUEplus screwdriver for slotted screws, 5,5 mm, 230 mm	1
18	159.1009	ERGOTORQUEplus screwdriver for slotted screws, 6,5 mm, 255 mm	1
19	159.1011	ERGOTORQUEplus screwdriver for slotted screws, 8 mm, 315 mm	1
20	159.1029	ERGOTORQUEplus screwdriver, Torx, PH1, 205 mm	1
21	159.1022	ERGOTORQUEplus screwdriver, Torx, PH2, 230 mm	1
22	159.1024	ERGOTORQUEplus screwdriver, Torx, PH3, 265 mm	1
23	159.1141	ERGOTORQUEplus screwdriver for screws PH, PH1, stubby	1
24	159.1143	ERGOTORQUEplus screwdriver for screws PZ, PZ1, stubby	1
25	159.1040	ERGOTORQUEplus screwdriver for screws PZ, PZ1, 180 mm	1
26	159.1041	ERGOTORQUEplus screwdriver for screws PZ, PZ2, 205 mm	1
27	159.1044	ERGOTORQUEplus screwdriver for screws PZ, PZ3, 265 mm	1

811.0034

M Screwdriver set

129,- EUR

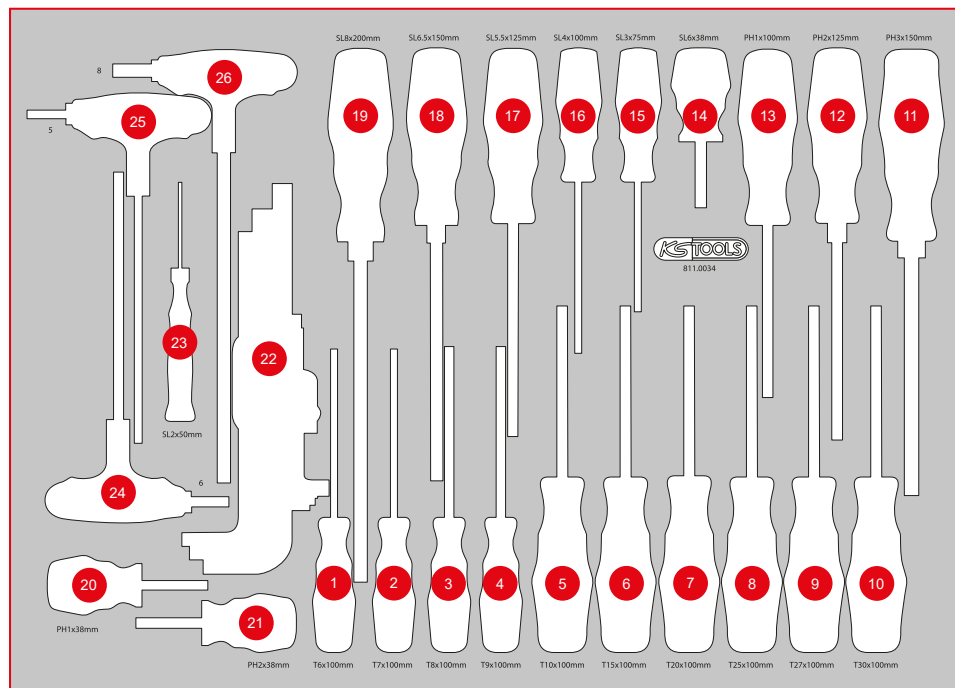
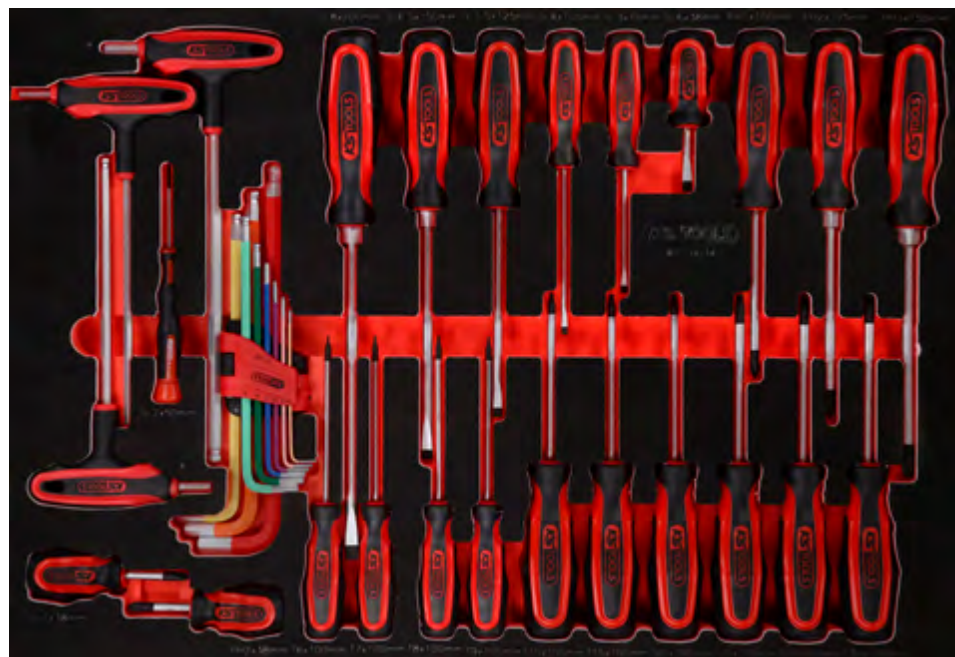

Pos.	Code	Description	pcs
1	159.1134	ERGOTORQUEplus screwdriver, Torx, T6	1
2	159.1135	ERGOTORQUEplus screwdriver, Torx, T7	1
3	159.1030	ERGOTORQUEplus screwdriver, Torx, T8	1
4	159.1031	ERGOTORQUEplus screwdriver, Torx, T9	1
5	159.1032	ERGOTORQUEplus screwdriver, Torx, T10	1
6	159.1033	ERGOTORQUEplus screwdriver, Torx, T15	1
7	159.1034	ERGOTORQUEplus screwdriver, Torx, T20	1
8	159.1035	ERGOTORQUEplus screwdriver, Torx, T25	1
9	159.1036	ERGOTORQUEplus screwdriver, Torx, T27	1
10	159.1037	ERGOTORQUEplus screwdriver, Torx, T30	1
11	159.1024	ERGOTORQUEplus screwdriver for screws PH, PH3, 265 mm	1
12	159.1022	ERGOTORQUEplus screwdriver for screws PH, PH2, 230 mm	1
13	159.1029	ERGOTORQUEplus screwdriver for screws PH, PH1, 205 mm	1
14	159.1001	ERGOTORQUEplus screwdriver for slotted screws, 6 mm, stubby	1
15	159.1002	ERGOTORQUEplus screwdriver for slotted screws, 3 mm, 155 mm	1
16	159.1004	ERGOTORQUEplus screwdriver for slotted screws, 4 mm, 180 mm	1
17	159.1006	ERGOTORQUEplus screwdriver for slotted screws, 5,5 mm, 230 mm	1
18	159.1009	ERGOTORQUEplus screwdriver for slotted screws, 6,5 mm, 255 mm	1
19	159.1011	ERGOTORQUEplus screwdriver for slotted screws, 8 mm, 315 mm	1
20	159.1141	ERGOTORQUEplus screwdriver for screws PH, PH1, stubby	1
21	159.1026	ERGOTORQUEplus screwdriver for screws PH, PH2, stubby	1
22	151.4420	Ball ended hexagon key wrench set, extra long, 9 pcs	9
23	500.7109	Precision screwdriver, slot, 2 mm	1
24	151.8135	T-handle ball ended hexagon key wrench, 6 mm	1
25	151.8134	T-handle ball ended hexagon key wrench, 5 mm	1
26	151.8137	T-handle ball ended hexagon key wrench, 8 mm	1

P 10

P 15

P 20

P 25

P 30

P 35

P 40

P 45

M

S

L

XL

Accessories

811.0041

M Screwdriver set

139,- *EUR*

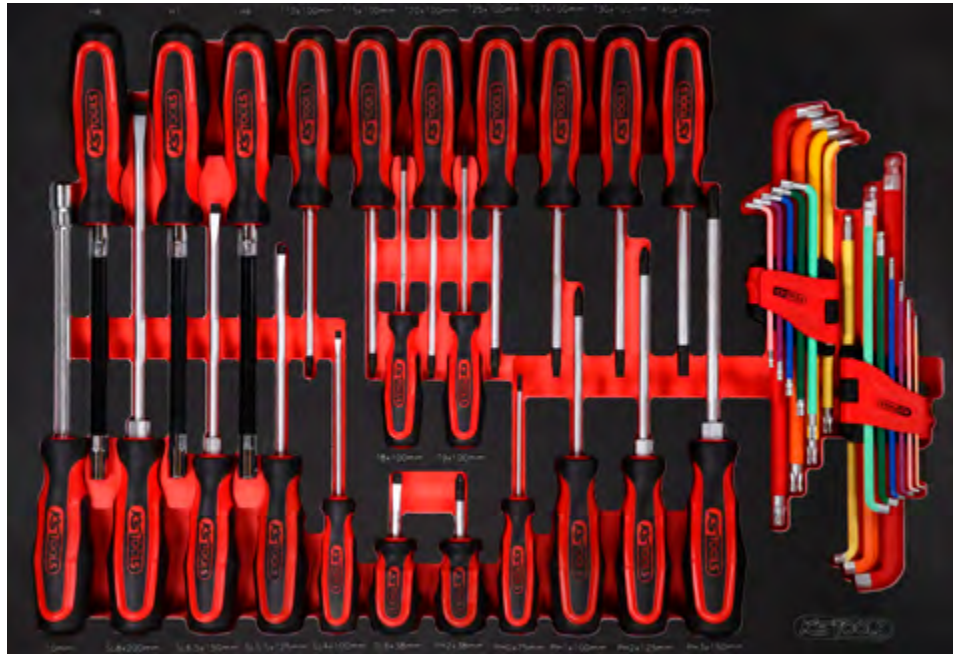

Pos.	Code	Description	pcs
1	911.1128	ERGOTORQUE Socket screwdriver, 8 mm	1
2	159.1127	ERGOTORQUEplus Socket screwdriver, 7 mm	1
3	159.1126	ERGOTORQUEplus Socket screwdriver, 6 mm	1
4	159.1032	ERGOTORQUEplus screwdriver, Torx, T10	1
5	159.1033	ERGOTORQUEplus screwdriver, Torx, T15	1
6	159.1034	ERGOTORQUEplus screwdriver, Torx, T20	1
7	159.1035	ERGOTORQUEplus screwdriver, Torx, T25	1
8	159.1036	ERGOTORQUEplus screwdriver, Torx, T27	1
9	159.1037	ERGOTORQUEplus screwdriver, Torx, T30	1
10	159.1038	ERGOTORQUEplus screwdriver, Torx, T40	1
11	159.1208	ERGOTORQUEplus socket screwdriver, 10 mm	1
12	159.1011	ERGOTORQUEplus screwdriver for slotted screws, 8 mm, 315 mm	1
13	159.1009	ERGOTORQUEplus screwdriver for slotted screws, 6,5 mm, 255 mm	1
14	159.1006	ERGOTORQUEplus screwdriver for slotted screws, 5,5 mm, 230 mm	1
15	159.1004	ERGOTORQUEplus screwdriver for slotted screws, 4 mm, 180 mm	1
16	159.1030	ERGOTORQUEplus screwdriver, Torx, T8	1
17	159.1031	ERGOTORQUEplus screwdriver, Torx, T9	1
18	159.1001	ERGOTORQUEplus screwdriver for slotted screws, 6 mm, stubby	1
19	159.1026	ERGOTORQUEplus screwdriver for screws PH, PH2, stubby	1
20	159.1027	ERGOTORQUEplus screwdriver for screws PH, PH0, 155 mm	1
21	159.1029	ERGOTORQUEplus screwdriver for screws PH, PH1, 205 mm	1
22	159.1022	ERGOTORQUEplus screwdriver for screws PH, PH2, 230 mm	1
23	159.1024	ERGOTORQUEplus screwdriver for screws PH, PH3, 265 mm	1
24	151.4530	Ball ended Torx key wrench set, extra long and bent 108°, 9 pcs	9
25	151.4560	Ball ended hexagon key wrench set, 108° angled, 9 pcs	9

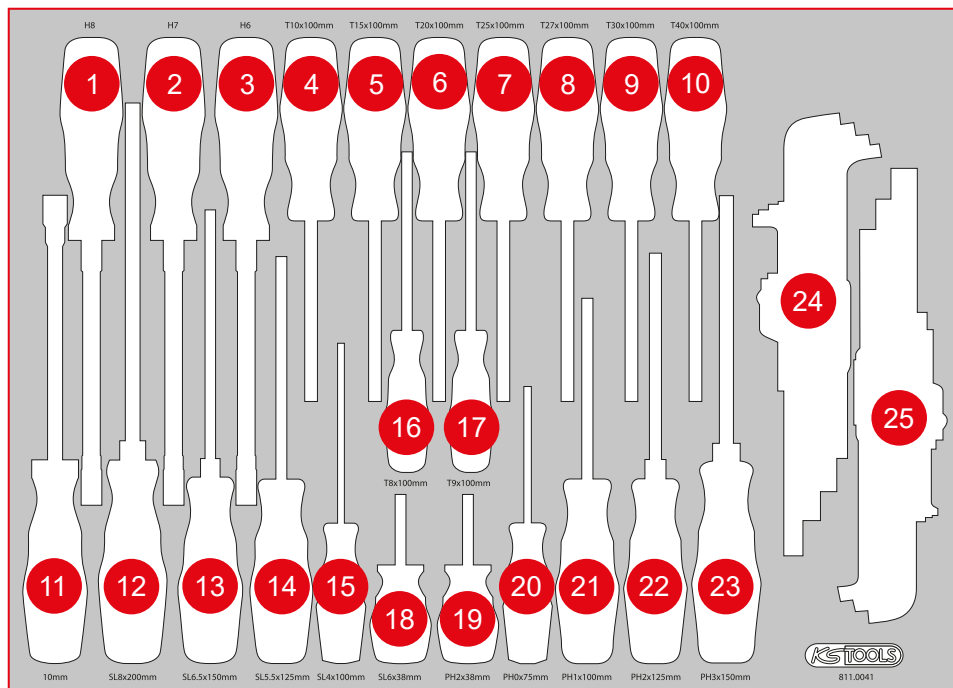

811.1019

M Screwdriver and hook set

129,- EUR



568 x 398

P10

P10TC

P15

P20

P30

P35

P45



Pos.	Code	Description	pcs
1	159.1128	EERGOTORQUEplus screwdriver for phillips screws PH, extra long, PH2, 405 mm	1
2	159.1107	ERGOTORQUEplus screwdriver for slotted screws, extra long, 5,5 mm, 405 mm	1
3	550.1047	Hook, 45° offset	1
4	550.1049	Hook, 135° bent	1
5	550.1046	Hook, straight	1
6	550.1048	Hook, 90° offset	1
7	550.1075	T hook, S form large, 165 mm	1
8	550.1074	T hook, S form small, 120 mm	1
9	151.1133	ERGOTORQUEmax hammer cap screwdriver slotted, 8 mm	1
10	151.1132	ERGOTORQUEmax hammer cap screwdriver slotted, 7 mm	1
11	151.1128	ERGOTORQUEmax hammer cap screwdriver slotted, 5,5 mm	1
12	151.1104	ERGOTORQUEmax hammer cap screwdriver, PH2, 185 mm	1
13	151.1102	ERGOTORQUEmax hammer cap screwdriver, PH1	1
14	140.2615	Clip remover short, length 240 mm, opening 9 mm	1
15	550.1071	Hook, large, straight	1
16	550.1072	Hook, large, 90° bent	1
17	550.1073	Hook, large, sickle	1
18	911.8101	Pry bar, 11 x 115 mm	1
19	911.8102	Pry bar, 15 x 185 mm	1

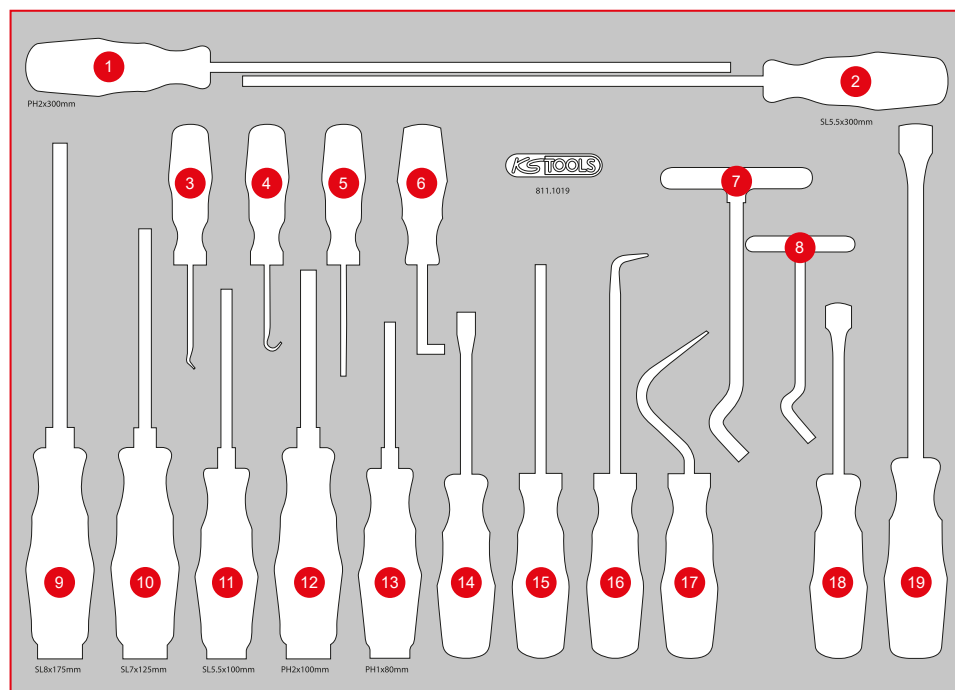

P 10

P 15

P 20

P 25

P 30

P 35

P 40

P 45

M

S

XL

L

Individual parts

Accessories

811.3024

M Screwdriver set

129,-^{EUR}



P10

P10TC

P15

P20

P30

P35

P45

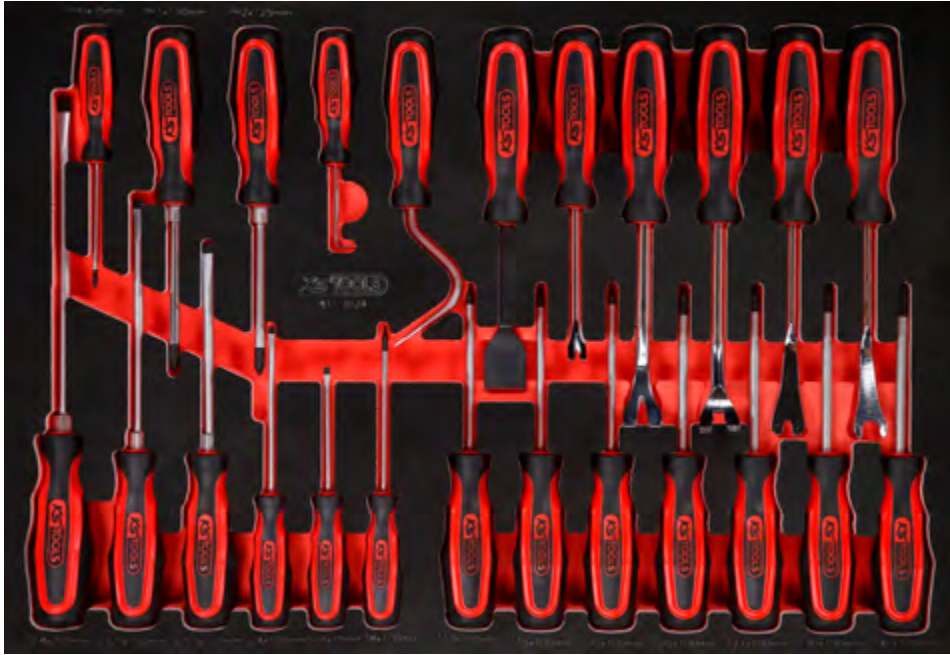

Pos.	Code	Description	pcs
1	159.1002	ERGOTORQUEplus screwdriver for slotted screws, 3 mm, 155 mm	1
2	159.1004	ERGOTORQUEplus screwdriver for slotted screws, 4 mm, 180 mm	1
3	159.1006	ERGOTORQUEplus screwdriver for slotted screws, 5,5 mm, 230 mm	1
4	159.1011	ERGOTORQUEplus screwdriver for slotted screws, 8 mm, 315 mm	1
5	159.1009	ERGOTORQUEplus screwdriver for slotted screws, 6,5 mm, 255 mm	1
6	159.1027	ERGOTORQUEplus screwdriver for screws PH, PH0, 155 mm	1
7	159.1029	ERGOTORQUEplus screwdriver for screws PH, PH1, 205 mm	1
8	159.1022	ERGOTORQUEplus screwdriver for screws PH, PH2, 230 mm	1
9	159.1030	ERGOTORQUEplus screwdriver, Torx, T8	1
10	159.1032	ERGOTORQUEplus screwdriver, Torx, T10	1
11	159.1033	ERGOTORQUEplus screwdriver, Torx, T15	1
12	159.1034	ERGOTORQUEplus screwdriver, Torx, T20	1
13	159.1035	ERGOTORQUEplus screwdriver, Torx, T25	1
14	159.1036	ERGOTORQUEplus screwdriver, Torx, T27	1
15	159.1037	ERGOTORQUEplus screwdriver, Torx, T30	1
16	159.1038	ERGOTORQUEplus screwdriver, Torx, T40	1
17	550.1048	Hook, 90° offset	1
18	550.1073	Hook, large, sickle	1
19	907.2222	Gasket scraper, 25 x 200 mm	1
20	140.2371	Clip remover short, length 245 mm, opening 4 mm	1
21	140.2616	Clip remover short, length 240 mm, opening 7,5 mm	1
22	140.2615	Clip remover short, length 240 mm, opening 9 mm	1
23	140.2617	Clip remover short, length 240 mm, opening 5 mm	1
24	140.2373	Clip remover short, length 245 mm, opening 10 mm	1

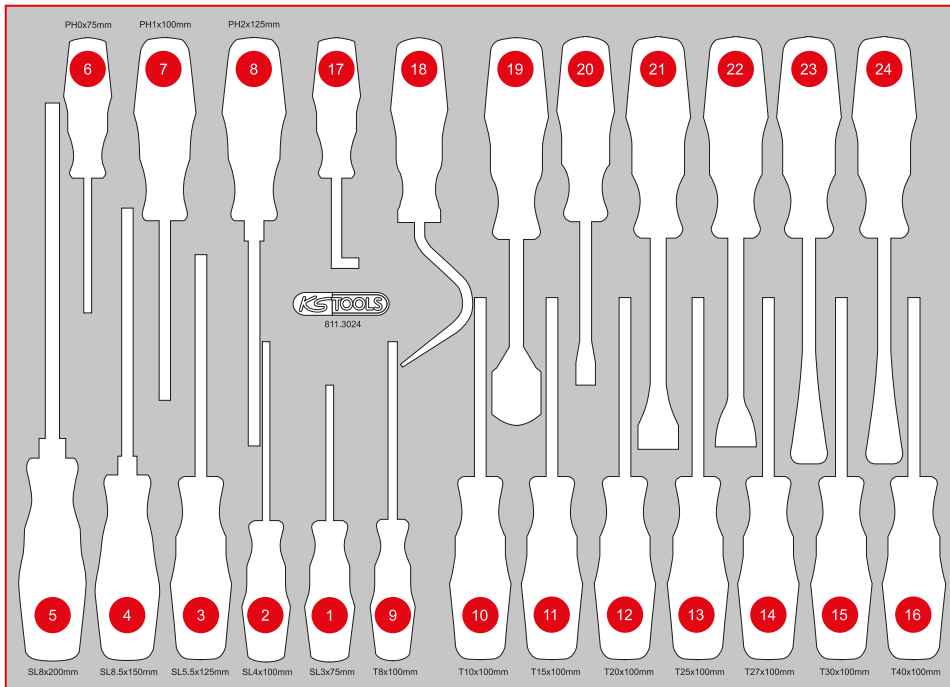

811.2018

M T-handle key wrench set

159,-^{EUR}



568 x 398

P10

P10TC

P15

P20

P30

P35

P45



Pos.	Code	Description	pcs
1	158.5006	T-handle socket screwdriver, long, 6mm	1
2	158.5010	T-handle socket screwdriver, long, 10 mm	1
3	158.5007	T-handle socket screwdriver, long, 7 mm	1
4	158.5012	T-handle socket screwdriver, long, 12 mm	1
5	158.5008	T-handle socket screwdriver, long, 8 mm	1
6	158.5013	T-handle socket screwdriver, long, 13 mm	1
7	158.5009	T-handle socket screwdriver, long, 9 mm	1
8	159.1126	ERGOTORQUEplus Socket screwdriver, 6 mm	1
9	159.1204	ERGOTORQUEplus Socket screwdriver, 6 mm	1
10	159.1205	ERGOTORQUEplus Socket screwdriver, 7 mm	1
11	159.1206	ERGOTORQUEplus Socket screwdriver, 8 mm	1
12	159.1207	ERGOTORQUEplus Socket screwdriver, 9 mm	1
13	159.1208	ERGOTORQUEplus Socket screwdriver, 10 mm	1
14	159.1209	ERGOTORQUEplus Socket screwdriver, 11 mm	1
15	159.1210	ERGOTORQUEplus Socket screwdriver, 12 mm	1
16	159.1211	ERGOTORQUEplus Socket screwdriver, 13 mm	1
17	159.1127	ERGOTORQUEplus Socket screwdriver, 7 mm	1
18	911.1128	ERGOTORQUE Socket screwdriver, 8 mm	1

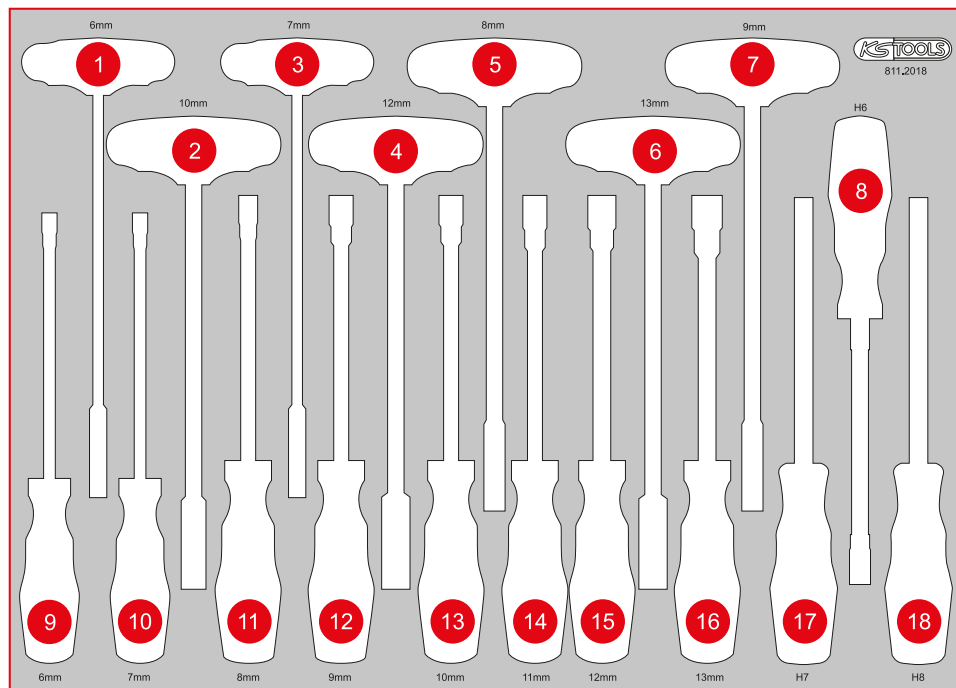

P 10

P 15

P 20

P 25

P 30

P 35

P 40

P 45

M

L

S

XL

Individual parts

Accessories

811.1022

M T-handle and screwdriver set

159,- *EUR*

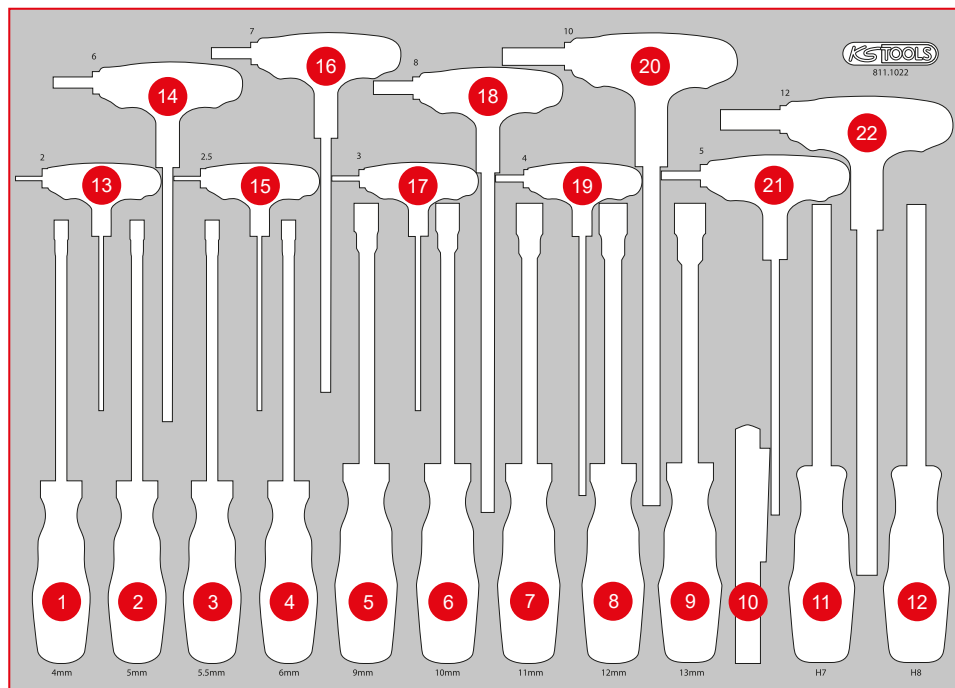

Pos.	Code	Description	pcs
1	159.1201	ERGOTORQUEplus Socket screwdriver, 4 mm	1
2	159.1202	ERGOTORQUEplus Socket screwdriver, 5 mm	1
3	159.1203	ERGOTORQUEplus Socket screwdriver, 5,5 mm	1
4	159.1204	ERGOTORQUEplus Socket screwdriver, 6 mm	1
5	159.1207	ERGOTORQUEplus Socket screwdriver, 9 mm	1
6	159.1208	ERGOTORQUEplus Socket screwdriver, 10 mm	1
7	159.1209	ERGOTORQUEplus Socket screwdriver, 11 mm	1
8	159.1210	ERGOTORQUEplus Socket screwdriver, 12 mm	1
9	159.1211	ERGOTORQUEplus Socket screwdriver, 13 mm	1
10	150.4370	perfectLight torch 85 lumen	1
11	159.1127	ERGOTORQUEplus Socket screwdriver, 7 mm	1
12	159.2128	ERGOTORQUEplus Socket screwdriver, 8 mm	1
13	151.8130	T-handle ball ended hexagon key wrench, 2 mm	1
14	151.8135	T-handle ball ended hexagon key wrench, 6 mm	1
15	151.8131	T-handle ball ended hexagon key wrench, 2,5 mm	1
16	151.8136	T-handle ball ended hexagon key wrench, 7 mm	1
17	151.8132	T-handle ball ended hexagon key wrench, 3 mm	1
18	151.8137	T-handle ball ended hexagon key wrench, 8 mm	1
19	151.8133	T-handle ball ended hexagon key wrench, 4 mm	1
20	151.8138	T-handle ball ended hexagon key wrench, 10 mm	1
21	151.8134	T-handle ball ended hexagon key wrench, 5 mm	1
22	151.8139	T-handle ball ended hexagon key wrench, 12 mm	1

811.1018

M T-handle key wrench set

119,-^{EUR}



P10



P10TC



P15



P20



P30



P35



P45

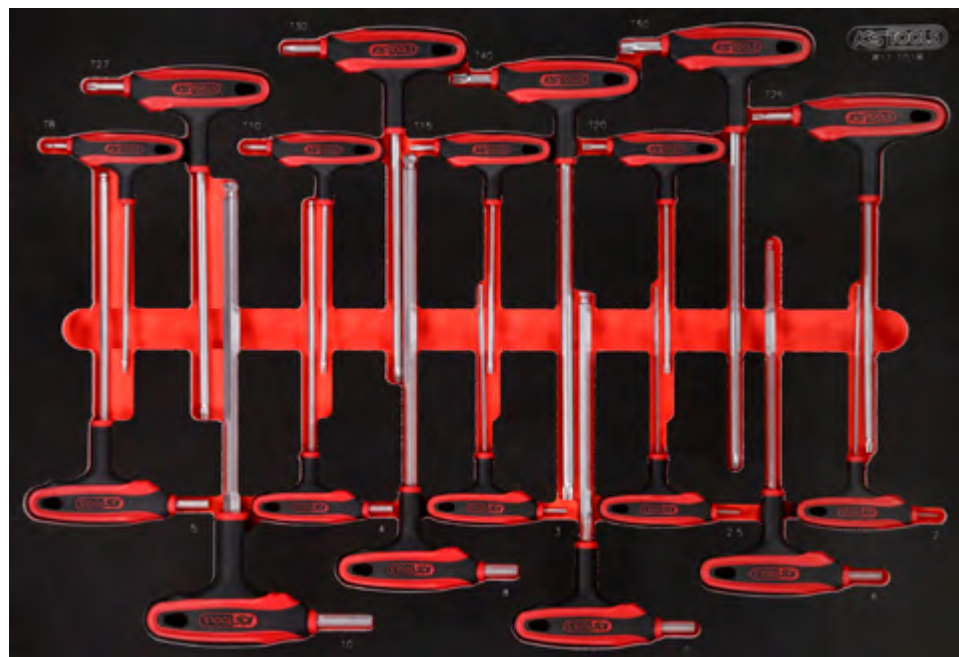

Pos.	Code	Description	pcs
1	151.2753	T-handle Torx key wrench, ball end, T8	1
2	151.2759	T-handle Torx key wrench, ball end, T27	1
3	151.2755	T-handle Torx key wrench, ball end, T10	1
4	151.2760	T-handle Torx key wrench, ball end, T30	1
5	151.2756	T-handle Torx key wrench, ball end, T15	1
6	151.2761	T-handle Torx key wrench, ball end, T40	1
7	151.2757	T-handle Torx key wrench, ball end, T20	1
8	151.2853	T-handle Torx key wrench, ball end, T50	1
9	151.2758	T-handle Torx key wrench, ball end, T25	1
10	151.8134	T-handle ball ended hexagon key wrench, 5 mm	1
11	151.8138	T-handle ball ended hexagon key wrench, 10 mm	1
12	151.8133	T-handle ball ended hexagon key wrench, 4 mm	1
13	151.8137	T-handle ball ended hexagon key wrench, 8 mm	1
14	151.8132	T-handle ball ended hexagon key wrench, 3 mm	1
15	151.8136	T-handle ball ended hexagon key wrench, 7 mm	1
16	151.8131	T-handle ball ended hexagon key wrench, 2,5 mm	1
17	151.8135	T-handle ball ended hexagon key wrench, 6 mm	1
18	151.8130	T-handle ball ended hexagon key wrench, 2 mm	1

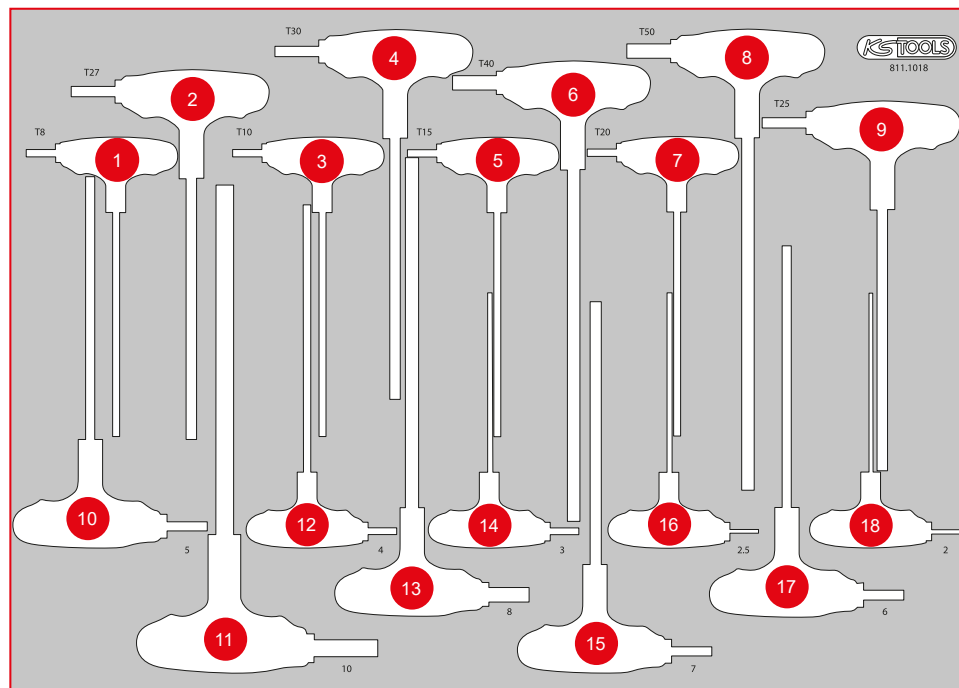

P 10

P 15

P 20

P 25

P 30

P 35

P 40

P 45

M

L

S

Individual parts

Accessories

811.0045

M Pliers and angle spanner set

299, ^{EUR}—

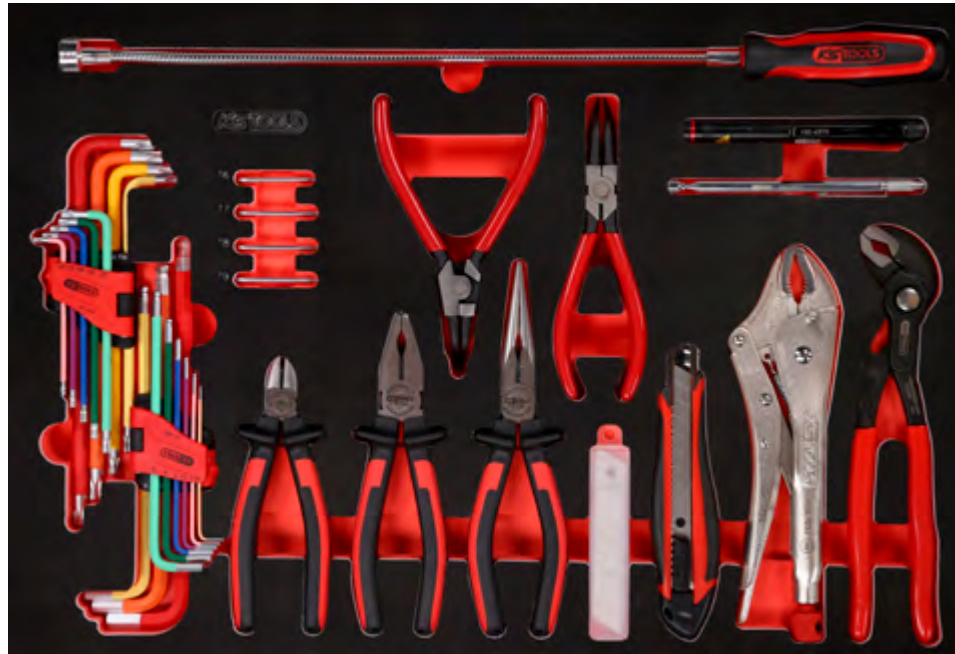

Pos.	Code	Description	pcs
1	151.5210	Ball head Torx angled socket wrench set, extra long, 9 pcs	9
2	151.4420	Ball ended hexagon key wrench set, extra long, 9 pcs	9
3	115.1012	ERGOTORQUE diagonal side cutter, 160 mm	1
4	115.1021	ERGOTORQUE combination pliers, 180 mm	1
5	115.1024	ERGOTORQUE long nose pliers serrated cutter, 200 mm	1
6	907.2166	Snap off blades 0,5 x 18 x 100 mm, dispenser with 10 pieces	10
7	907.2135	Universal snap off blade knife 18 mm	1
8	115.1033	Self grip wrench, 220 mm	1
9	115.2010	Water pump pliers, 240 mm	1
10	500.1035	Circlip pliers for internal circlips, 160 mm	1
11	500.1032	Circlip pliers for internal circlips, angled, 160 mm	1
12	500.1029	Circlip pliers for external circlips, 160 mm	1
13	500.1026	Circlip pliers for external circlips, angled, 160 mm	1
14	151.2341	Torx key wrench, short, T6	1
15	151.2342	Torx key wrench, short, T7	1
16	151.2343	Torx key wrench, short, T8	1
17	151.2344	Torx key wrench, short, T9	1
18	550.1001	2in1 Telescopic solenoid holder with washer jet cleaning and setting tool, 150-675 mm	1
19	150.4370	perfectLight torch 85 lumen	1
20	550.1025	Flexible magnet lifter, 510 mm, Øhead=15 mm	1

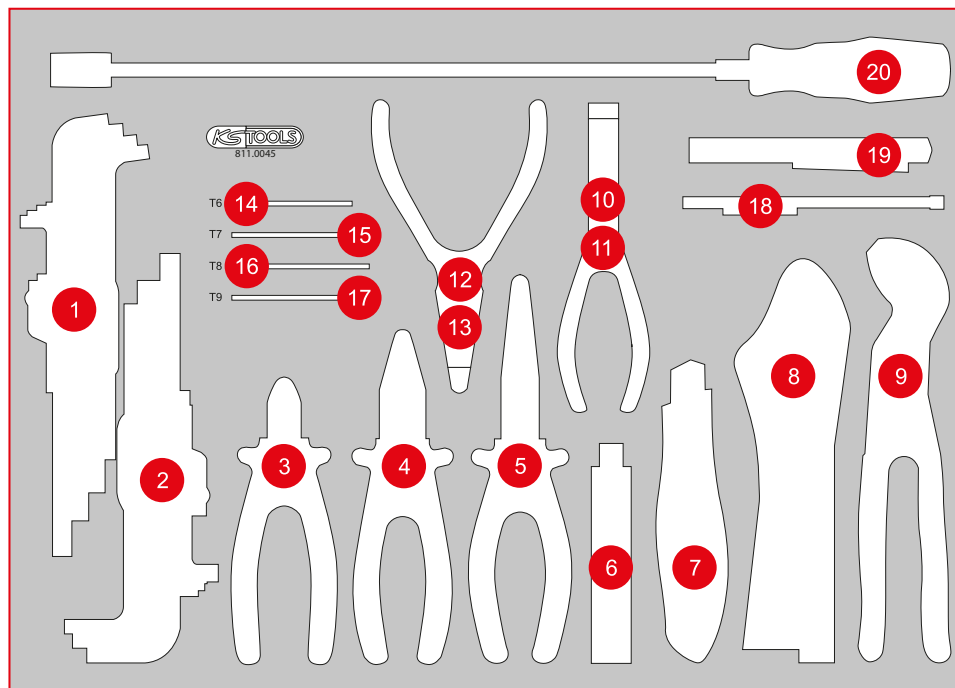



P 10

P 15

P 20

P 25

P 30

P 35

P 40

P 45

M

L

S

XL

Individual parts

Accessories

PERFORMANCE AT A GLANCE

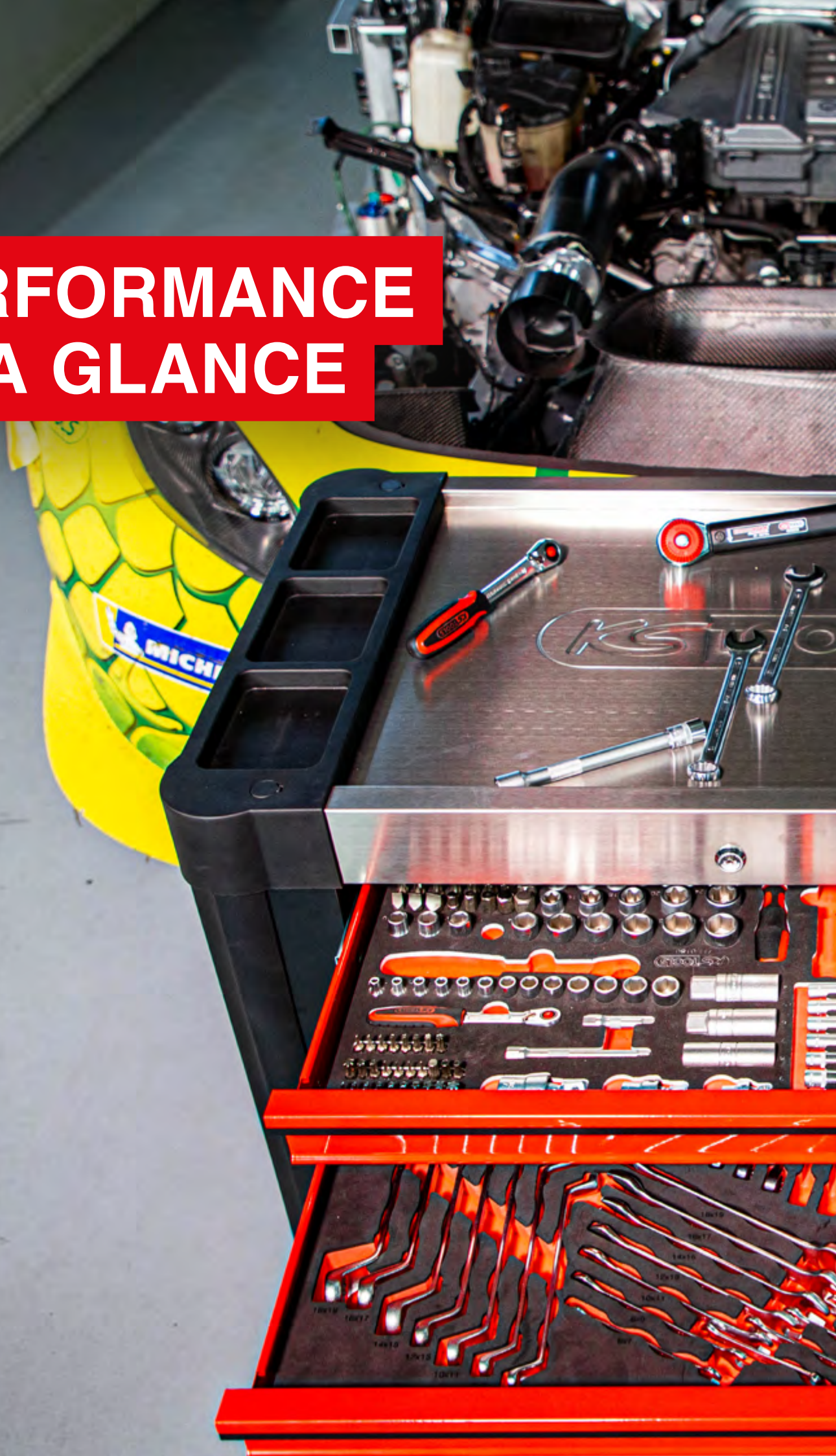

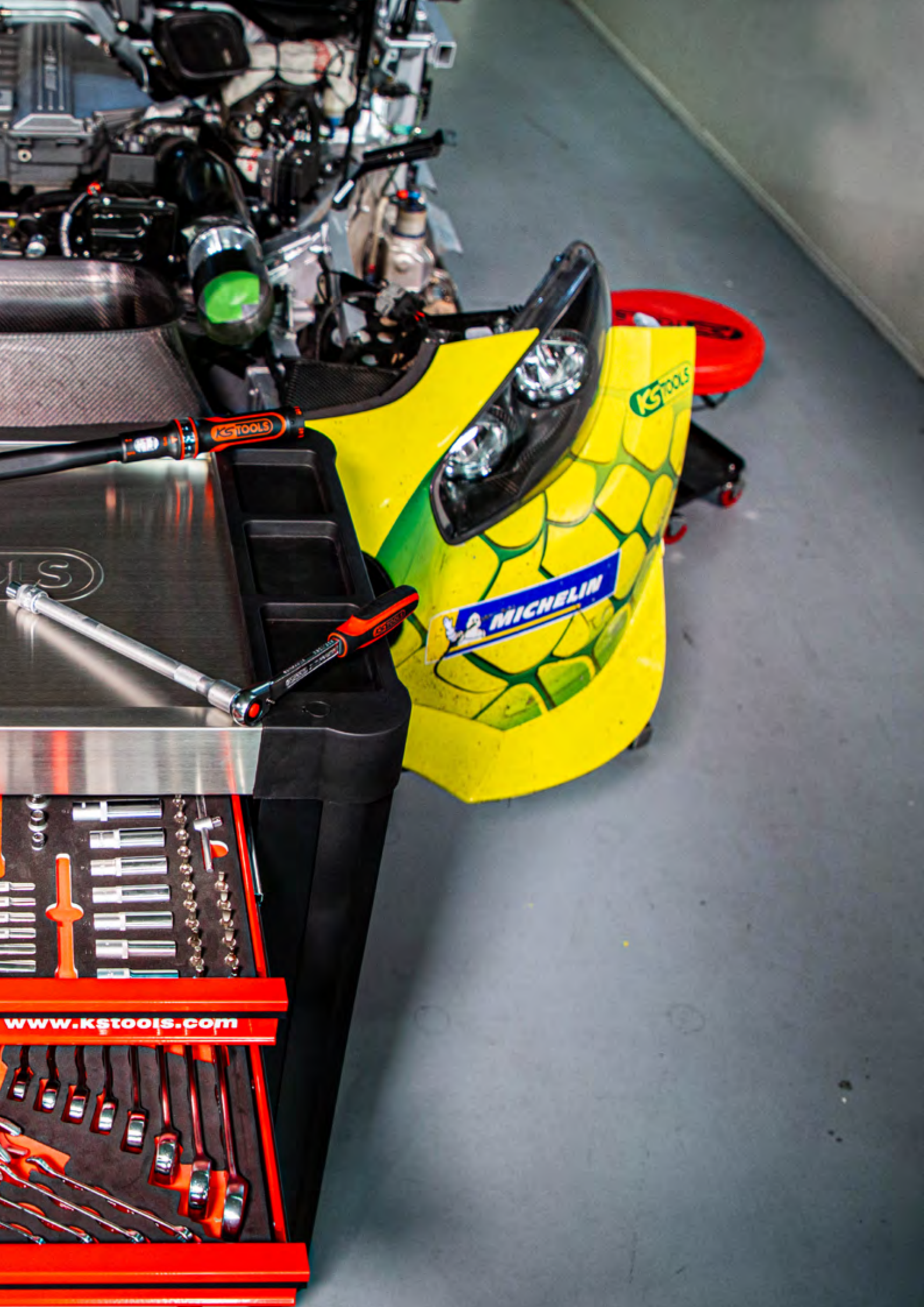

KSTOOLS

MICHELIN

www.kstools.com

811.0030

M Combination spanner set

329, ^{EUR}-



568 x 398



P10



P10TC



P15



P20



P30



P35



P45



Pos.	Code	Description	pcs
1	517.0606	Combination spanners, offset, 6mm	1
2	517.0607	Combination spanners, offset, 7 mm	1
3	517.0608	Combination spanners, offset, 8 mm	1
4	517.0609	Combination spanners, offset, 9 mm	1
5	517.0610	Combination spanners, offset, 10 mm	1
6	517.0611	Combination spanners, offset, 11 mm	1
7	517.0612	Combination spanners, offset, 12 mm	1
8	517.0613	Combination spanners, offset, 13 mm	1
9	517.0614	Combination spanners, offset, 14 mm	1
10	517.0615	Combination spanners, offset, 15 mm	1
11	517.0616	Combination spanners, offset, 16 mm	1
12	517.0617	Combination spanners, offset, 17 mm	1
13	517.0618	Combination spanners, offset, 18 mm	1
14	517.0619	Combination spanners, offset, 19 mm	1
15	517.0620	Combination spanners, offset, 20 mm	1
16	517.0621	Combination spanners, offset, 21 mm	1
17	517.0622	Combination spanners, offset, 22 mm	1
18	517.0623	Combination spanners, offset, 23 mm	1
19	517.0624	Combination spanners, offset, 24 mm	1
20	517.0625	Combination spanners, offset, 25 mm	1
21	517.0626	Combination spanners, offset, 26 mm	1
22	517.0627	Combination spanners, offset, 27 mm	1
23	517.0628	Combination spanners, offset, 28 mm	1
24	517.0629	Combination spanners, offset, 29 mm	1
25	517.0630	Combination spanners, offset, 30 mm	1
26	517.0632	Combination spanners, offset, 32 mm	1
27	517.0337	Combination spanners, offset, 33 mm	1
28	517.0634	Combination spanners, offset, 34 mm	1
29	517.0636	Combination spanners, offset, 36 mm	1
30	517.0638	Combination spanners, offset, 38 mm	1

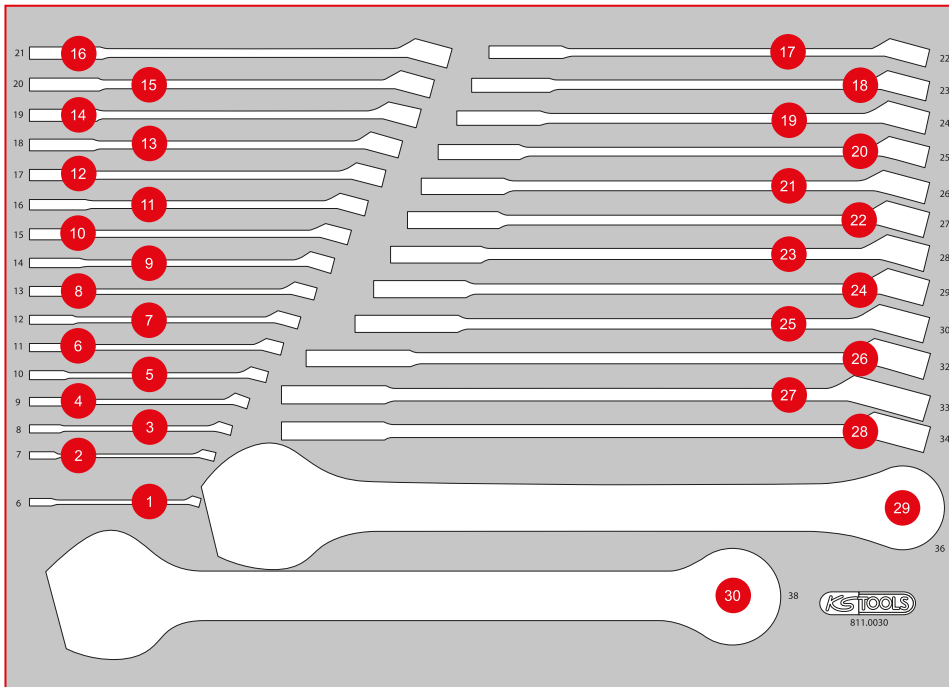

811.1024

M Screw spanner set

329,- EUR



568 x 398



P10



P10TC



P15



P20



P30



P35



P45

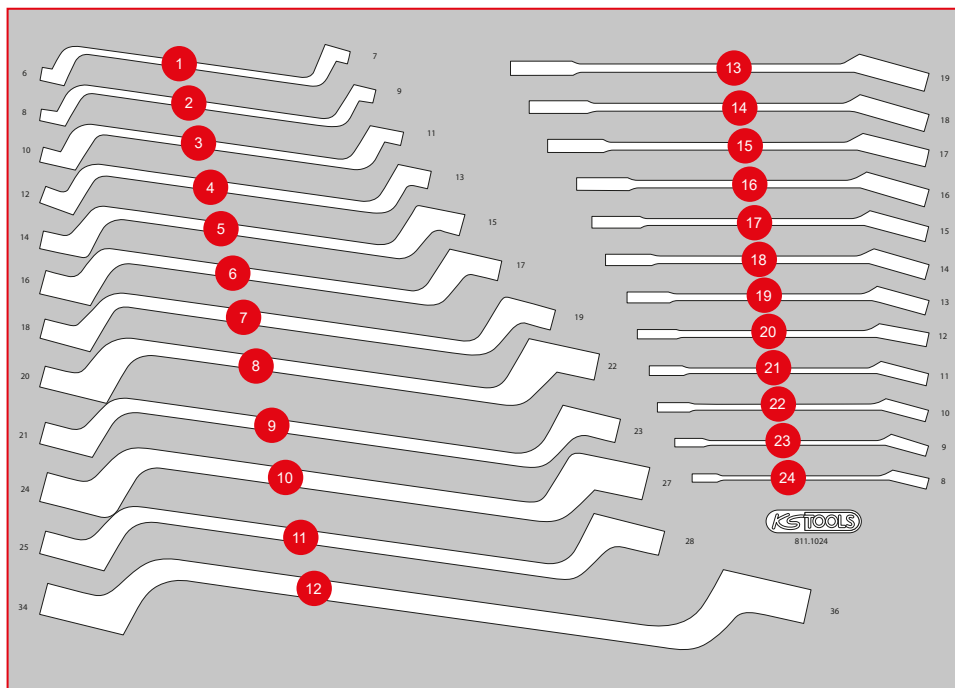

Pos.	Code	Description	pcs
1	517.0801	Double ring spanner, offset, 6 x 7 mm	1
2	517.0802	Double ring spanner, offset, 8 x 9 mm	1
3	517.0804	Double ring spanner, offset, 10 x 11 mm	1
4	517.0807	Double ring spanner, offset, 12 x 13 mm	1
5	517.0809	Double ring spanner, offset, 14 x 15 mm	1
6	517.0810	Double ring spanner, offset, 16 x 17 mm	1
7	517.0812	Double ring spanner, offset, 18 x 19 mm	1
8	517.0813	Double ring spanner, offset, 20 x 22 mm	1
9	517.0815	Double ring spanner, offset, 21 x 23 mm	1
10	517.0816	Double ring spanner, offset, 24 x 27 mm	1
11	517.0857	Double ring spanner, offset, 25 x 28 mm	1
12	517.0818	Double ring spanner, offset, 30 x 32 mm	1
13	503.4619	GEARplus reversing combination ratcheting spanner, 19 mm	1
14	503.4618	GEARplus reversing combination ratcheting spanner, 18 mm	1
15	503.4617	GEARplus reversing combination ratcheting spanner, 17 mm	1
16	503.4616	GEARplus reversing combination ratcheting spanner, 16 mm	1
17	503.4615	GEARplus reversing combination ratcheting spanner, 15 mm	1
18	503.4614	GEARplus reversing combination ratcheting spanner, 14 mm	1
19	503.4613	GEARplus reversing combination ratcheting spanner, 13 mm	1
20	503.4612	GEARplus reversing combination ratcheting spanner, 12 mm	1
21	503.4611	GEARplus reversing combination ratcheting spanner, 11 mm	1
22	503.4610	GEARplus reversing combination ratcheting spanner, 10 mm	1
23	503.4609	GEARplus reversing combination ratcheting spanner, 9 mm	1
24	503.4608	GEARplus reversing combination ratcheting spanner, 8 mm	1

P 10

P 15

P 20

P 25

P 30

P 35

P 40

P 45

M

L

S

Individual parts

Accessories

811.0038

M Screw spanner set

259,- *EUR*

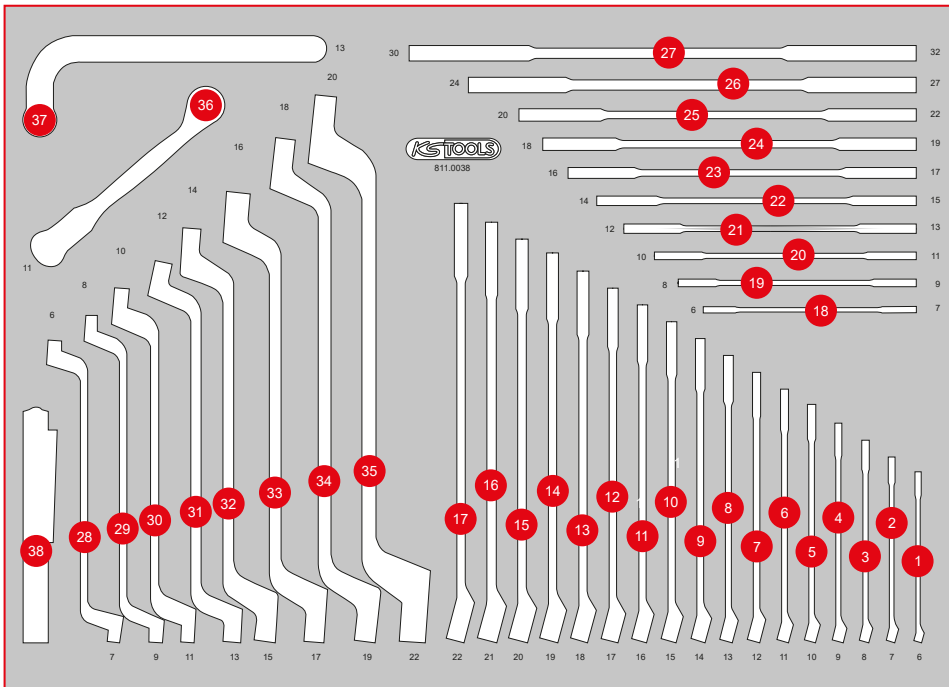

Pos.	Code	Description	pcs
1	517.0606	Combination spanners, offset, 6 mm	1
2	517.0607	Combination spanners, offset, 7 mm	1
3	517.0608	Combination spanners, offset, 8 mm	1
4	517.0609	Combination spanners, offset, 9 mm	1
5	517.0610	Combination spanners, offset, 10 mm	1
6	517.0611	Combination spanners, offset, 11 mm	1
7	517.0612	Combination spanners, offset, 12 mm	1
8	517.0613	Combination spanners, offset, 13 mm	1
9	517.0614	Combination spanners, offset, 14 mm	1
10	517.0615	Combination spanners, offset, 15 mm	1
11	517.0616	Combination spanners, offset, 16 mm	1
12	517.0617	Combination spanners, offset, 17 mm	1
13	517.0618	Combination spanners, offset, 18 mm	1
14	517.0619	Combination spanners, offset, 19 mm	1
15	517.0620	Combination spanners, offset, 20 mm	1
16	517.0621	Combination spanners, offset, 21 mm	1
17	517.0622	Combination spanners, offset, 22 mm	1
18	517.0701	Double open ended spanners, 6 x 7mm	1
19	517.0702	Double open ended spanners, 8 x 9 mm	1
20	517.0704	Double open ended spanners, 10 x 11 mm	1
21	517.0707	Double open ended spanners, 12 x 13 mm	1
22	517.0709	Double open ended spanners, 14 x 15 mm	1
23	517.0710	Double open ended spanners, 16 x 17 mm	1
24	517.0712	Double open ended spanners, 18 x 19 mm	1
25	517.0714	Double open ended spanners, 20 x 22 mm	1
26	517.0716	Double open ended spanners, 24 x 27 mm	1
27	517.0718	Double open ended spanners, 30 x 32 mm	1
28	517.0801	Double ring spanner, offset, 6 x 7 mm	1
29	517.0802	Double ring spanner, offset, 8 x 9 mm	1
30	517.0804	Double ring spanner, offset, 10 x 11 mm	1
31	517.0807	Double ring spanner, offset, 12 x 13 mm	1
32	517.0809	Double ring spanner, offset, 14 x 15 mm	1
33	517.0810	Double ring spanner, offset, 16 x 17 mm	1
34	517.0812	Double ring spanner, offset, 18 x 19 mm	1
35	517.0813	Double ring spanner, offset, 20 x 22 mm	1
36	518.0381	CHROMEplus Open double ring spanner, with flexible joint, 11 mm	1
37	152.1396	Injector pump wrench 13 mm	1
38	150.4370	perfectLight torch 85 lumen	1

811.1040

M Screw spanner set

269,- EUR



568 x 398

P10

P10TC

P15

P20

P30

P35

P45

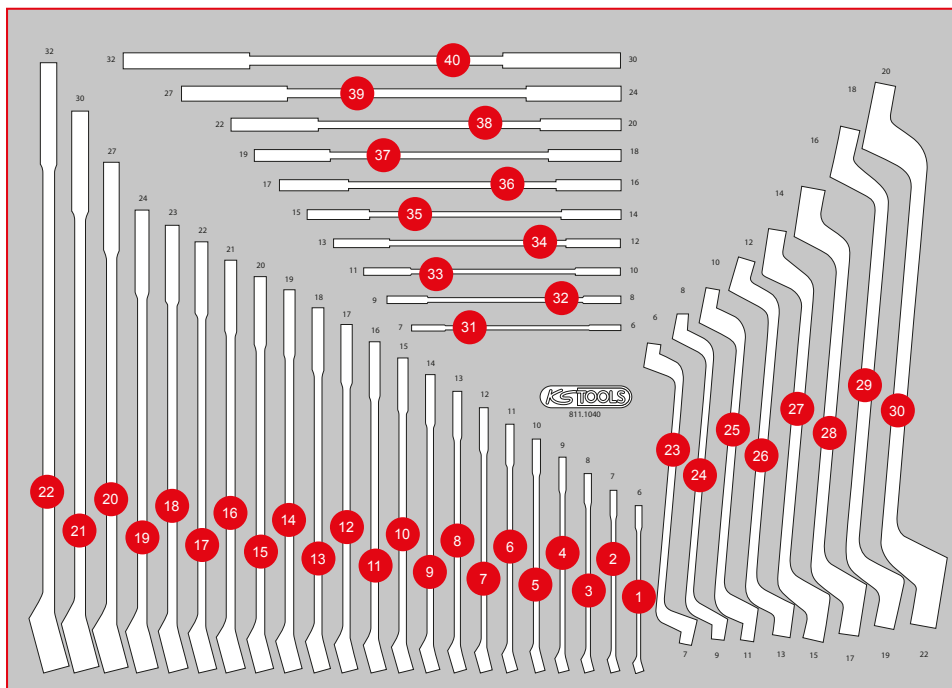

Pos.	Code	Description	pcs
1	517.0606	Combination spanners, offset, 6 mm	1
2	517.0607	Combination spanners, offset, 7 mm	1
3	517.0608	Combination spanners, offset, 8 mm	1
4	517.0609	Combination spanners, offset, 9 mm	1
5	517.0610	Combination spanners, offset, 10 mm	1
6	517.0611	Combination spanners, offset, 11 mm	1
7	517.0612	Combination spanners, offset, 12 mm	1
8	517.0613	Combination spanners, offset, 13 mm	1
9	517.0614	Combination spanners, offset, 14 mm	1
10	517.0615	Combination spanners, offset, 15 mm	1
11	517.0616	Combination spanners, offset, 16 mm	1
12	517.0617	Combination spanners, offset, 17 mm	1
13	517.0618	Combination spanners, offset, 18 mm	1
14	517.0619	Combination spanners, offset, 19 mm	1
15	517.0620	Combination spanners, offset, 20 mm	1
16	517.0621	Combination spanners, offset, 21 mm	1
17	517.0622	Combination spanners, offset, 22 mm	1
18	517.0623	Combination spanners, offset, 23 mm	1
19	517.0624	Combination spanners, offset, 24 mm	1
20	517.0627	Combination spanners, offset, 27 mm	1
21	517.0630	Combination spanners, offset, 30 mm	1
22	517.0632	Combination spanners, offset, 32 mm	1
23	517.0701	Double open ended spanners, 6 x 7 mm	1
24	517.0702	Double open ended spanners, 8 x 9 mm	1
25	517.0704	Double open ended spanners, 10 x 11 mm	1
26	517.0707	Double open ended spanners, 12 x 13 mm	1
27	517.0709	Double open ended spanners, 14 x 15 mm	1
28	517.0710	Double open ended spanners, 16 x 17 mm	1
29	517.0712	Double open ended spanners, 18 x 19 mm	1
30	517.0714	Double open ended spanners, 20 x 22 mm	1
31	517.0716	Double open ended spanners, 24 x 27 mm	1
32	517.0718	Double open ended spanners, 30 x 32 mm	1
33	517.0801	Double ring spanner, offset, 6 x 7 mm	1
34	517.0802	Double ring spanner, offset, 8 x 9 mm	1
35	517.0804	Double ring spanner, offset, 10 x 11 mm	1
36	517.0807	Double ring spanner, offset, 12 x 13 mm	1
37	517.0809	Double ring spanner, offset, 14 x 15 mm	1
38	517.0810	Double ring spanner, offset, 16 x 17 mm	1
39	517.0812	Double ring spanner, offset, 18 x 19 mm	1
40	517.0813	Double ring spanner, offset, 20 x 22 mm	1

P 10
P 15
P 20
P 25
P 30
P 35
P 40
P 45
S
XL
L
M
Individual parts
Accessories

811.1041

M Screw spanner set

269, ^{EUR}—

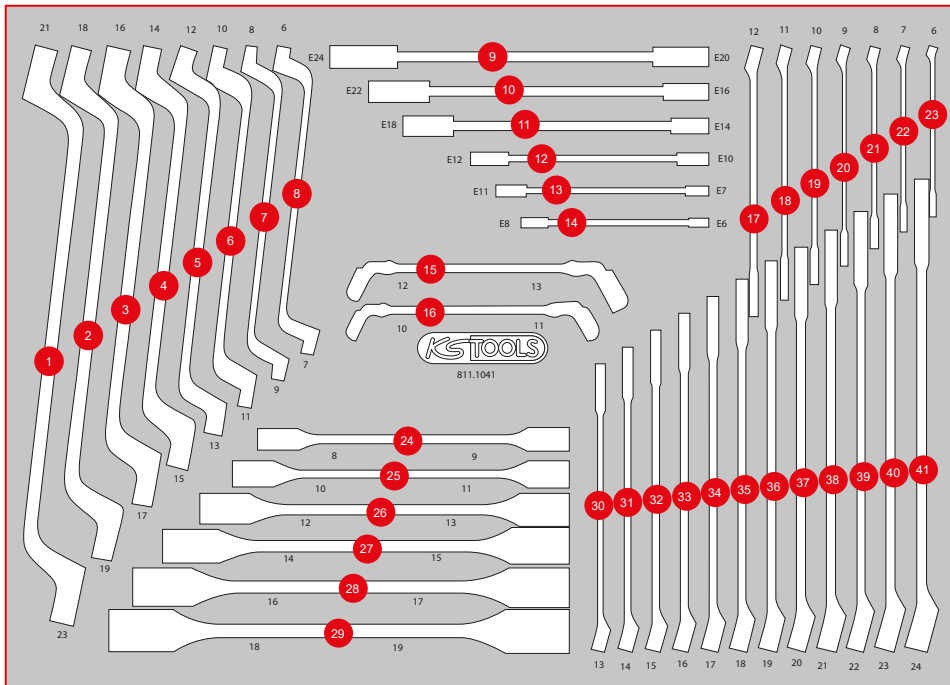

Pos.	Code	Description	pcs
1	517.0815	Double ring spanner, offset, 21 x 23 mm	1
2	517.0812	Double ring spanner, offset, 18 x 19 mm	1
3	517.0810	Double ring spanner, offset, 16 x 17 mm	1
4	517.0809	Double ring spanner, offset, 14 x 15 mm	1
5	517.0807	Double ring spanner, offset, 12 x 13 mm	1
6	517.0804	Double ring spanner, offset, 10 x 11 mm	1
7	517.0802	Double ring spanner, offset, 8 x 9 mm	1
8	517.0801	Double ring spanner, offset, 6 x 7 mm	1
9	911.0376	Double ring spanner for Torx E profile, E20 x E24	1
10	911.0375	Double ring spanner for Torx E profile, E16 x E22	1
11	911.0374	Double ring spanner for Torx E profile, E14 x E18	1
12	911.0373	Double ring spanner for Torx E profile, E10 x E12	1
13	911.0372	Double ring spanner for Torx E profile, E7 x E11	1
14	911.0371	Double ring spanner for Torx E profile, E6 x E8	1
15	518.0529	Open double ring spanner, with double joint, 12 x 13 mm	1
16	518.0528	Open double ring spanner, with double joint, 10 x 11	1
17	517.0612	Combination spanners, offset, 12 mm	1
18	517.0611	Combination spanners, offset, 11 mm	1
19	517.0610	Combination spanners, offset, 10 mm	1
20	517.0609	Combination spanners, offset, 9 mm	1
21	517.0608	Combination spanners, offset, 8 mm	1
22	517.0607	Combination spanners, offset, 7 mm	1
23	517.0606	Combination spanners, offset, 6 mm	1
24	517.0301	Double revolving head spanner, 8 x 9mm	1
25	517.0302	Double revolving head spanner, 10 x 11 mm	1
26	517.0303	Double revolving head spanner, 12 x 13 mm	1
27	517.0304	Double revolving head spanner, 14 x 15 mm	1
28	517.0305	Double revolving head spanner, 16 x 17 mm	1
29	517.0306	Double revolving head spanner, 18 x 19 mm	1
30	517.0613	Combination spanners, offset, 13 mm	1
31	517.0614	Combination spanners, offset, 14 mm	1
32	517.0615	Combination spanners, offset, 15 mm	1
33	517.0616	Combination spanners, offset, 16 mm	1
34	517.0617	Combination spanners, offset, 17 mm	1
35	517.0618	Combination spanners, offset, 18 mm	1
36	517.0619	Combination spanners, offset, 19 mm	1
37	517.0620	Combination spanners, offset, 20 mm	1
38	517.0621	Combination spanners, offset, 21 mm	1
39	517.0622	Combination spanners, offset, 22 mm	1
40	517.0623	Combination spanners, offset, 23 mm	1
41	517.0624	Combination spanners, offset, 24 mm	1

811.2041

M Screw spanner set

269, ^{EUR}—

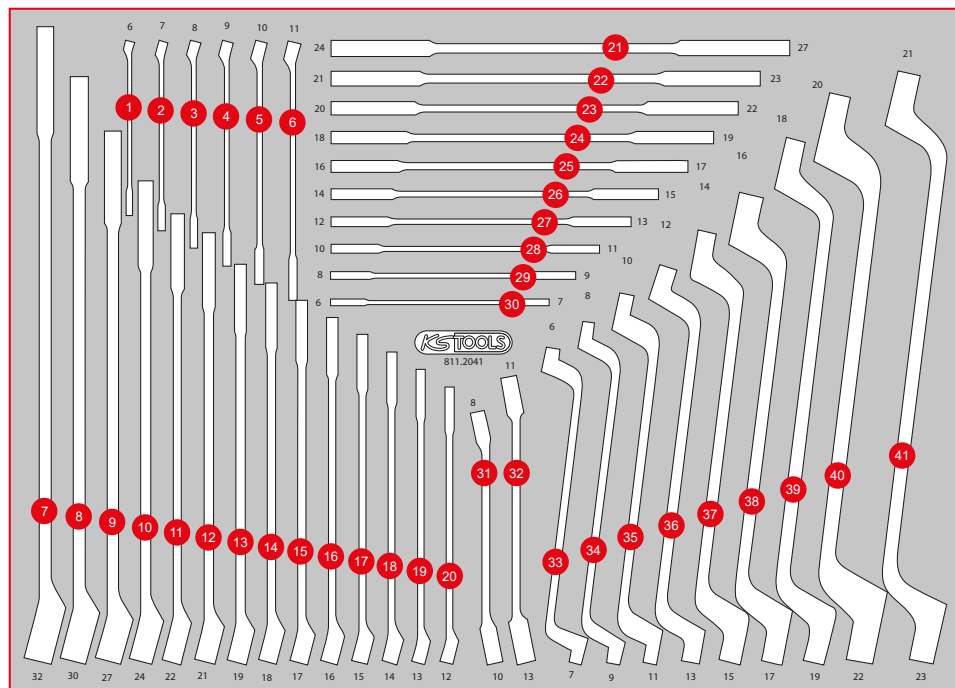

Pos.	Code	Description	pcs
1	517.0606	Combination spanners, offset, 6 mm	1
2	517.0607	Combination spanners, offset, 7 mm	1
3	517.0608	Combination spanners, offset, 8 mm	1
4	517.0609	Combination spanners, offset, 9 mm	1
5	517.0610	Combination spanners, offset, 10 mm	1
6	517.0611	Combination spanners, offset, 11 mm	1
7	517.0632	Combination spanners, offset, 32 mm	1
8	517.0630	Combination spanners, offset, 30 mm	1
9	517.0627	Combination spanners, offset, 27 mm	1
10	517.0624	Combination spanners, offset, 24 mm	1
11	517.0622	Combination spanners, offset, 22 mm	1
12	517.0621	Combination spanners, offset, 21 mm	1
13	517.0619	Combination spanners, offset, 19 mm	1
14	517.0618	Combination spanners, offset, 18 mm	1
15	517.0617	Combination spanners, offset, 17 mm	1
16	517.0616	Combination spanners, offset, 16 mm	1
17	517.0615	Combination spanners, offset, 15 mm	1
18	517.0614	Combination spanners, offset, 14 mm	1
19	517.0613	Combination spanners, offset, 13 mm	1
20	517.0612	Combination spanners, offset, 12 mm	1
21	517.0716	Double open ended spanners, 24 x 27 mm	1
22	517.0715	Double open ended spanners, 21 x 23 mm	1
23	517.0714	Double open ended spanners, 20 x 22 mm	1
24	517.0712	Double open ended spanners, 18 x 19 mm	1
25	517.0710	Double open ended spanners, 16 x 17 mm	1
26	517.0709	Double open ended spanners, 14 x 15 mm	1
27	517.0707	Double open ended spanners, 12 x 13 mm	1
28	517.0704	Double open ended spanners, 10 x 11 mm	1
29	517.0702	Double open ended spanners, 8 x 9 mm	1
30	517.0701	Double open ended spanners, 6 x 7 mm	1
31	517.0252	Open double ring spanner, offset, 8 x 10 mm	1
32	517.9244	Open double ring spanner, offset, 11 x 13 mm	1
33	517.0801	Double ring spanner, offset, 6 x 7 mm	1
34	517.0802	Double ring spanner, offset, 8 x 9 mm	1
35	517.0804	Double ring spanner, offset, 10 x 11 mm	1
36	517.0807	Double ring spanner, offset, 12 x 13 mm	1
37	517.0809	Double ring spanner, offset, 14 x 15 mm	1
38	517.0810	Double ring spanner, offset, 16 x 17 mm	1
39	517.0812	Double ring spanner, offset, 18 x 19 mm	1
40	517.0813	Double ring spanner, offset, 20 x 22 mm	1
41	517.0815	Double ring spanner, offset, 21 x 23 mm	1

P 10
P 15
P 20
P 25
P 30
P 35
P 40
P 45
Individual parts S XL L M
Accessories

811.0046

M Screw spanner set



299, ^{EUR}-

46

568 x 398

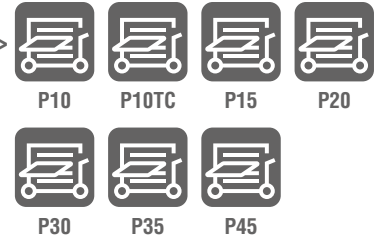

Pos.	Code	Description	pcs	Pos.	Code	Description	pcs	Pos.	Code	Description	pcs
1	517.0606	Combination spanners, offset, 6 mm	1	10	517.0615	Combination spanners, offset, 15 mm	1	19	911.0371	Double ring spanner for Torx E profile, E6 x E8	1
2	517.0607	Combination spanners, offset, 7 mm	1	11	517.0616	Combination spanners, offset, 16 mm	1	20	911.0373	Double ring spanner for Torx E profile, E10 x E12	1
3	517.0608	Combination spanners, offset, 8 mm	1	12	517.0617	Combination spanners, offset, 17 mm	1	21	911.0374	Double ring spanner for Torx E profile, E14 x E18	1
4	517.0609	Combination spanners, offset, 9 mm	1	13	517.0618	Combination spanners, offset, 18 mm	1	22	911.0376	Double ring spanner for Torx E profile, E20 x E24	1
5	517.0610	Combination spanners, offset, 10 mm	1	14	517.0619	Combination spanners, offset, 19 mm	1	23	920.0406	ULTIMATEplus Double ring ended spanner, 6 x 7 mm	1
6	517.0611	Combination spanners, offset, 11 mm	1	15	517.0621	Combination spanners, offset, 21 mm	1	24	920.0408	ULTIMATEplus Double ring ended spanner, 8 x 9 mm	1
7	517.0612	Combination spanners, offset, 12 mm	1	16	517.0622	Combination spanners, offset, 22 mm	1				
8	517.0613	Combination spanners, offset, 13 mm	1	17	517.0624	Combination spanners, offset, 24 mm	1				
9	517.0614	Combination spanners, offset, 14 mm	1	18	517.0627	Combination spanners, offset, 27 mm	1				

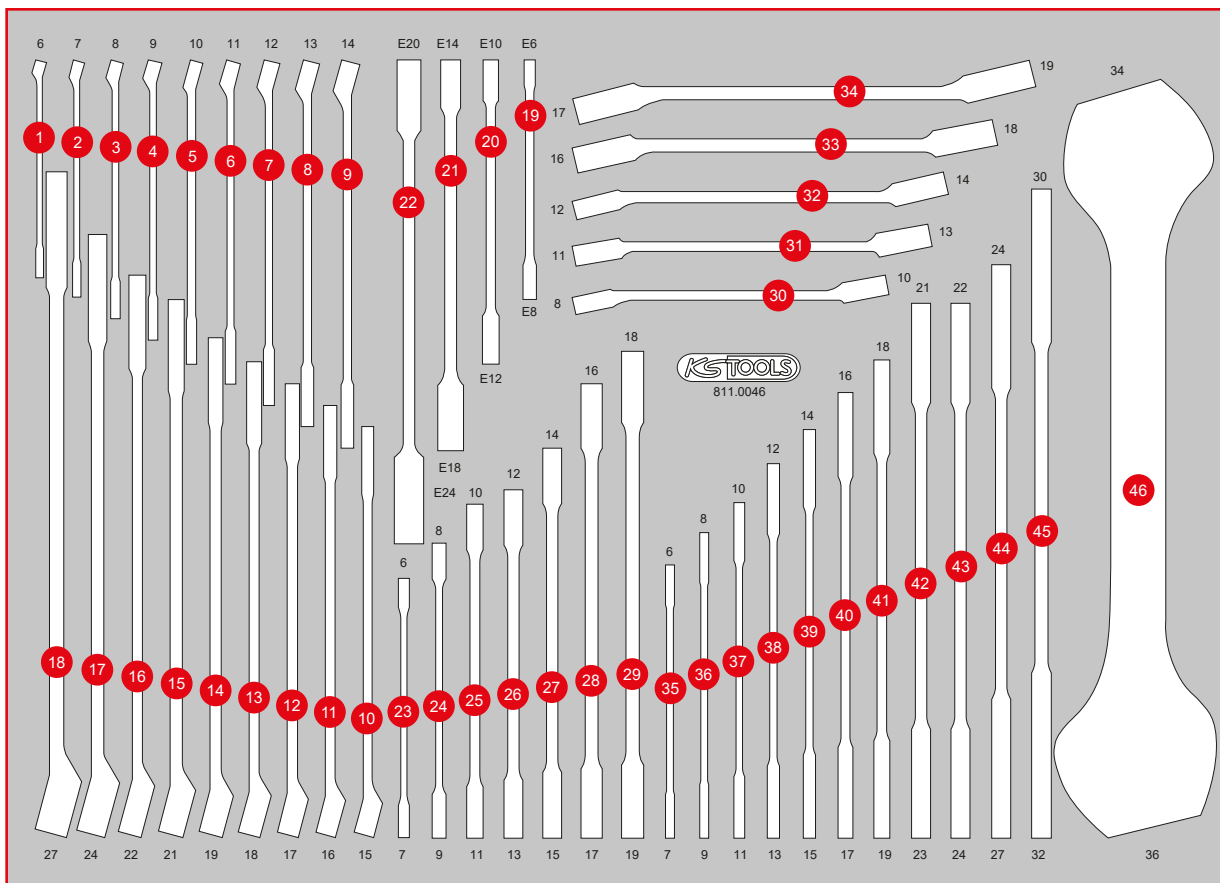

Pos.	Code	Description	pcs	Pos.	Code	Description	pcs	Pos.	Code	Description	pcs
25	920.0410	ULTIMATEplus Double ring ended spanner, 10 x 11 mm	1	30	517.0252	Open double ring spanner, offset, 8 x 10 mm	1	39	517.0709	Double open ended spanners, 14 x 15 mm	1
26	920.0412	ULTIMATEplus Double ring ended spanner, 12 x 13 mm	1	31	517.9244	Open double ring spanner, offset, 11 x 13 mm	1	40	517.0710	Double open ended spanners, 16 x 17 mm	1
27	920.0414	ULTIMATEplus Double ring ended spanner, 14 x 15 mm	1	32	517.0258	Open double ring spanner, offset, 12 x 14 mm	1	41	517.0712	Double open ended spanners, 18 x 19 mm	1
28	920.0416	ULTIMATEplus Double ring ended spanner, 16 x 17 mm	1	33	517.0263	Open double ring spanner, offset, 16 x 18 mm	1	42	517.0715	Double open ended spanners, 21 x 23 mm	1
29	920.0418	ULTIMATEplus Double ring ended spanner, 18 x 19 mm	1	34	517.0264	Open double ring spanner, offset, 17 x 19 mm	1	43	517.0736	Double open ended spanners, 22 x 24 mm	1
				35	517.0701	Double open ended spanners, 6 x 7 mm	1	44	517.0716	Double open ended spanners, 24 x 27 mm	1
				36	517.0702	Double open ended spanners, 8 x 9 mm	1	45	517.0718	Double open ended spanners, 30 x 32 mm	1
				37	517.0704	Double open ended spanners, 10 x 11 mm	1	46	517.0773	Double open ended spanners, 34 x 36 mm	1
				38	517.0707	Double open ended spanners, 12 x 13 mm	1				

P 10
P 15
P 20
P 25
P 30
P 35
P 40
P 45
Accessories Individual parts S XL L M

811.0049

M Screw spanner set

329,-^{EUR}



568 x 398

P10

P10TC

P15

P20

P30

P35

P45

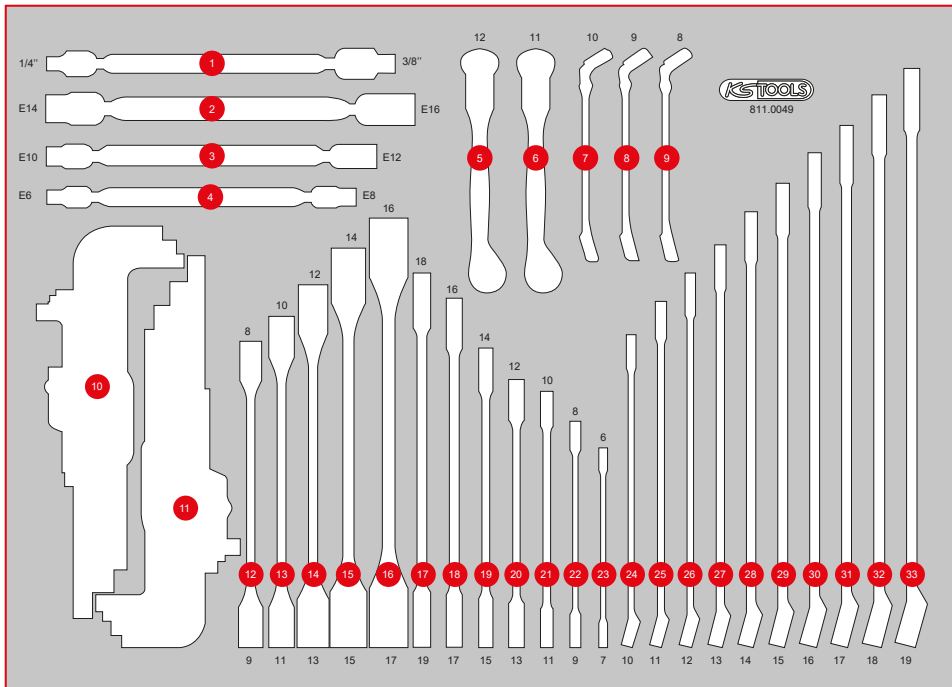
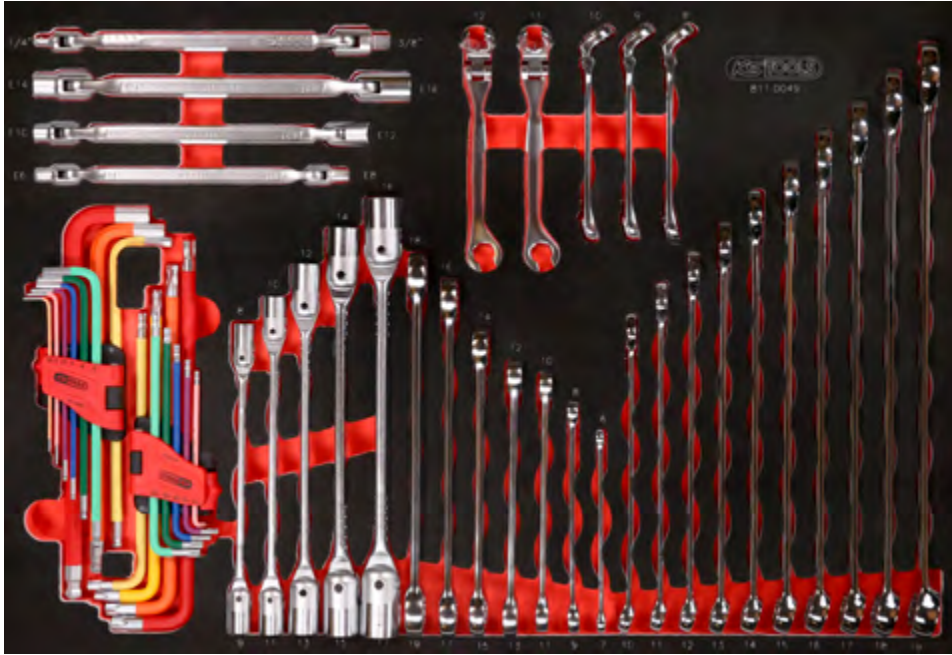

Pos.	Code	Description	pcs
1	517.0338	Double-joint-spanner for 1/4" and 3/8" sockets	1
2	517.0333	Double revolving head spanner for Torx E profile, E14 x E16	1
3	517.0332	Double revolving head spanner for Torx E profile, E10 x E12	1
4	517.0330	Double revolving head spanner for Torx E profile, E6 x E8	1
5	518.0382	CHROMEplus Open double ring spanner, with flexible joint, 12 mm	1
6	518.0381	CHROMEplus Open double ring spanner, with flexible joint, 11 mm	1
7	518.0380	CHROMEplus Open double ring spanner, with flexible joint, 10 mm	1
8	518.0379	CHROMEplus Open double ring spanner, with flexible joint, 9 mm	1
9	518.0378	CHROMEplus Open double ring spanner, with flexible joint, 8 mm	1
10	151.4420	Ball ended hexagon key wrench set, extra long, 9 pcs	9
11	151.5210	Ball head Torx angled socket wrench set, extra long, 9 pcs	9
12	517.0301	Double revolving head spanner, 8 x 9 mm	1
13	517.0302	Double revolving head spanner, 10 x 11 mm	1
14	517.0303	Double revolving head spanner, 12 x 13 mm	1
15	517.0304	Double revolving head spanner, 14 x 15 mm	1
16	517.0305	Double revolving head spanner, 16 x 17 mm	1
17	920.0418	ULTIMATEplus Double ring ended spanner, 18 x 19 mm	1
18	920.0416	ULTIMATEplus Double ring ended spanner, 16 x 17 mm	1
19	920.0414	ULTIMATEplus Double ring ended spanner, 14 x 15 mm	1
20	920.0412	ULTIMATEplus Double ring ended spanner, 12 x 13 mm	1
21	920.0410	ULTIMATEplus Double ring ended spanner, 10 x 11 mm	1
22	920.0408	ULTIMATEplus Double ring ended spanner, 8 x 9 mm	1
23	920.0406	ULTIMATEplus Double ring ended spanner, 6 x 7 mm	1
24	519.0650	CHROMEplus Combination spanner, extra long, 10 mm	1
25	519.0651	CHROMEplus Combination spanner, extra long, 11 mm	1
26	519.0652	CHROMEplus Combination spanner, extra long, 12 mm	1
27	519.0653	CHROMEplus Combination spanner, extra long, 13 mm	1
28	519.0654	CHROMEplus Combination spanner, extra long, 14 mm	1
29	519.0655	CHROMEplus Combination spanner, extra long, 15 mm	1
30	519.0656	CHROMEplus Combination spanner, extra long, 16 mm	1
31	519.0657	CHROMEplus Combination spanner, extra long, 17 mm	1
32	519.0658	CHROMEplus Combination spanner, extra long, 18 mm	1
33	519.0659	CHROMEplus Combination spanner, extra long, 19 mm	1



P 10

P 15

P 20

P 25

P 30

P 35

P 40

P 45

M

L

XL

S

Individual parts

Accessories

811.0050

M Screw spanner set



389,^{EUR}—

50 PCS

568 x 398

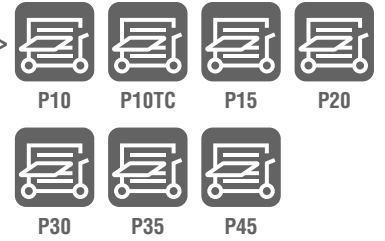

Pos.	Code	Description	pcs	Pos.	Code	Description	pcs	Pos.	Code	Description	pcs
1	517.0606	Combination spanners, offset, 6 mm	1	11	517.0623	Combination spanners, offset, 23 mm	1	21	503.4617	GEARplus reversing combination ratcheting spanner, 17 mm	1
2	517.0607	Combination spanners, offset, 7 mm	1	12	517.0622	Combination spanners, offset, 22 mm	1	22	503.4616	GEARplus reversing combination ratcheting spanner, 16 mm	1
3	517.0608	Combination spanners, offset, 8 mm	1	13	517.0621	Combination spanners, offset, 21 mm	1	23	503.4615	GEARplus reversing combination ratcheting spanner, 15 mm	1
4	517.0609	Combination spanners, offset, 9 mm	1	14	517.0620	Combination spanners, offset, 20 mm	1	24	503.4614	GEARplus reversing combination ratcheting spanner, 14 mm	1
5	517.0610	Combination spanners, offset, 10 mm	1	15	517.0619	Combination spanners, offset, 19 mm	1	25	503.4608	GEARplus reversing combination ratcheting spanner, 8 mm	1
6	517.0611	Combination spanners, offset, 11 mm	1	16	517.0618	Combination spanners, offset, 18 mm	1	26	503.4609	GEARplus reversing combination ratcheting spanner, 9 mm	1
7	517.0612	Combination spanners, offset, 12 mm	1	17	517.0617	Combination spanners, offset, 17 mm	1				
8	517.0613	Combination spanners, offset, 13 mm	1	18	517.0616	Combination spanners, offset, 16 mm	1				
9	517.0614	Combination spanners, offset, 14 mm	1	19	517.0615	Combination spanners, offset, 15 mm	1				
10	517.0624	Combination spanners, offset, 24 mm	1	20	503.4619	GEARplus reversing combination ratcheting spanner, 19 mm	1				

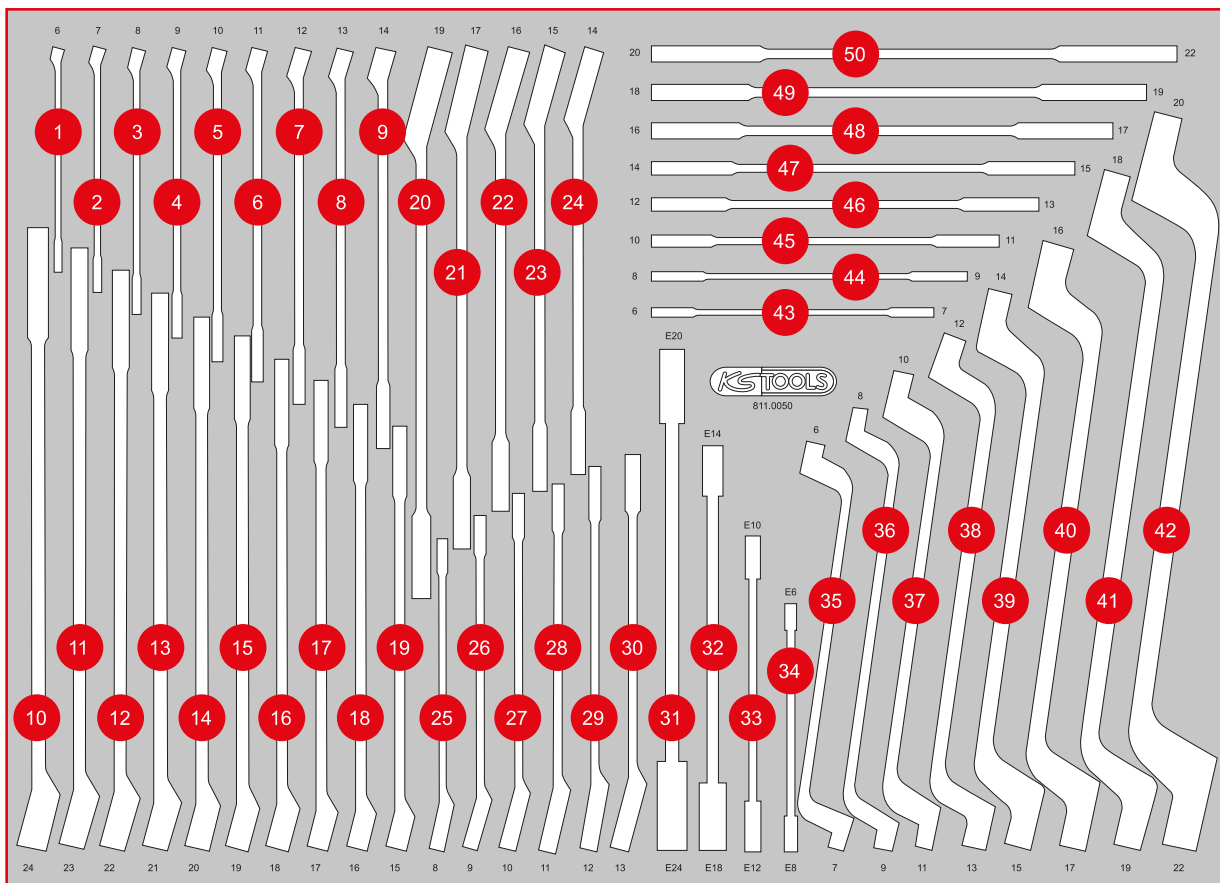

Pos.	Code	Description	pcs	Pos.	Code	Description	pcs	Pos.	Code	Description	pcs
27	503.4610	GEARplus reversing combination ratcheting spanner, 10 mm	1	33	911.0373	Double ring spanner for Torx E profile, E10 x E12	1	42	517.0813	Double ring spanner, offset, 20 x 22 mm	1
28	503.4611	GEARplus reversing combination ratcheting spanner, 11 mm	1	34	911.0371	Double ring spanner for Torx E profile, E6 x E8	1	43	517.0701	Double open ended spanners, 6 x 7 mm	1
29	503.4612	GEARplus reversing combination ratcheting spanner, 12 mm	1	35	517.0801	Double ring spanner, offset, 6 x 7 mm	1	44	517.0702	Double open ended spanners, 8 x 9 mm	1
30	503.4613	GEARplus reversing combination ratcheting spanner, 13 mm	1	36	517.0802	Double ring spanner, offset, 8 x 9 mm	1	45	517.0704	Double open ended spanners, 10 x 11 mm	1
31	911.0376	Double ring spanner for Torx E profile, E20 x E24	1	37	517.0804	Double ring spanner, offset, 10 x 11 mm	1	46	517.0707	Double open ended spanners, 12 x 13 mm	1
32	911.0374	Double ring spanner for Torx E profile, E14 x E18	1	38	517.0807	Double ring spanner, offset, 12 x 13 mm	1	47	517.0709	Double open ended spanners, 14 x 15 mm	1
				39	517.0809	Double ring spanner, offset, 14 x 15 mm	1	48	517.0710	Double open ended spanners, 16 x 17 mm	1
				40	517.0810	Double ring spanner, offset, 16 x 17 mm	1	49	517.0712	Double open ended spanners, 18 x 19 mm	1
				41	517.0812	Double ring spanner, offset, 18 x 19 mm	1	50	517.0714	Double open ended spanners, 20 x 22 mm	1

P 10
P 15
P 20
P 25
P 30
P 35
P 40
P 45
Individual parts S XL L M
Accessories

811.0051

M Screw spanner set



399,^{EUR}—

51

568 x 398

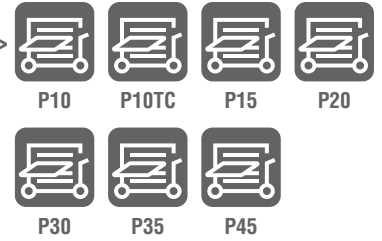

Pos.	Code	Description	pcs
1	518.0856	CHROMEplus Starter and block spanner, 14 x 17mm	1
2	518.0853	CHROMEplus Starter and block spanner, 11 x 13 mm	1
3	518.0852	CHROMEplus Starter and block spanner, 10 x 12 mm	1
4	503.4290	GEARplus bit adaptor, 1/4" x 10mm	1
5	503.4296	GEARplus socket adaptor, 1/4" x10 mm	1
6	503.4297	GEARplus socket adaptor, 3/8" x 13 mm	1
7	503.4298	GEARplus socket adaptor, 1/2" x 19 mm	1
8	517.0269	Open double ring spanner, offset, 30 x 32 mm	1
9	517.0268	Open double ring spanner, offset, 24 x 27 mm	1
10	517.0266	Open double ring spanner, offset, 19 x 22 mm	1
11	517.0264	Open double ring spanner, offset, 17 x 19 mm	1
12	517.0263	Open double ring spanner, offset, 16 x 18 mm	1

Pos.	Code	Description	pcs
13	517.0258	Open double ring spanner, offset, 12 x 14 mm	1
14	517.9244	Open double ring spanner, offset, 11 x 13 mm	1
15	517.0252	Open double ring spanner, offset, 8 x 10 mm	1
16	517.0300	Double revolving head spanner, 6 x 7 mm	1
17	517.0301	Double revolving head spanner, 8 x 9 mm	1
18	517.0302	Double revolving head spanner, 10 x 11 mm	1
19	517.0303	Double revolving head spanner, 12 x 13 mm	1
20	517.0304	Double revolving head spanner, 14 x 15 mm	1
21	517.0305	Double revolving head spanner, 16 x 17 mm	1
22	517.0306	Double revolving head spanner, 18 x 19 mm	1
23	920.0418	ULTIMATEplus Double ring ended spanner, 18 x 19 mm	1
24	920.0416	ULTIMATEplus Double ring ended spanner, 16 x 17 mm	1

Pos.	Code	Description	pcs
25	920.0414	ULTIMATEplus Double ring ended spanner, 14 x 15 mm	1
26	920.0412	ULTIMATEplus Double ring ended spanner, 12 x 13 mm	1
27	920.0410	ULTIMATEplus Double ring ended spanner, 10 x 11 mm	1
28	920.0408	ULTIMATEplus Double ring ended spanner, 8 x 9 mm	1
29	920.0406	ULTIMATEplus Double ring ended spanner, 6 x 7 mm	1
30	518.0017	CHROMEplus Combination spanner, stubby, 17 mm	1
31	518.0016	CHROMEplus Combination spanner, stubby, 16 mm	1
32	518.0015	CHROMEplus Combination spanner, stubby, 15 mm	1

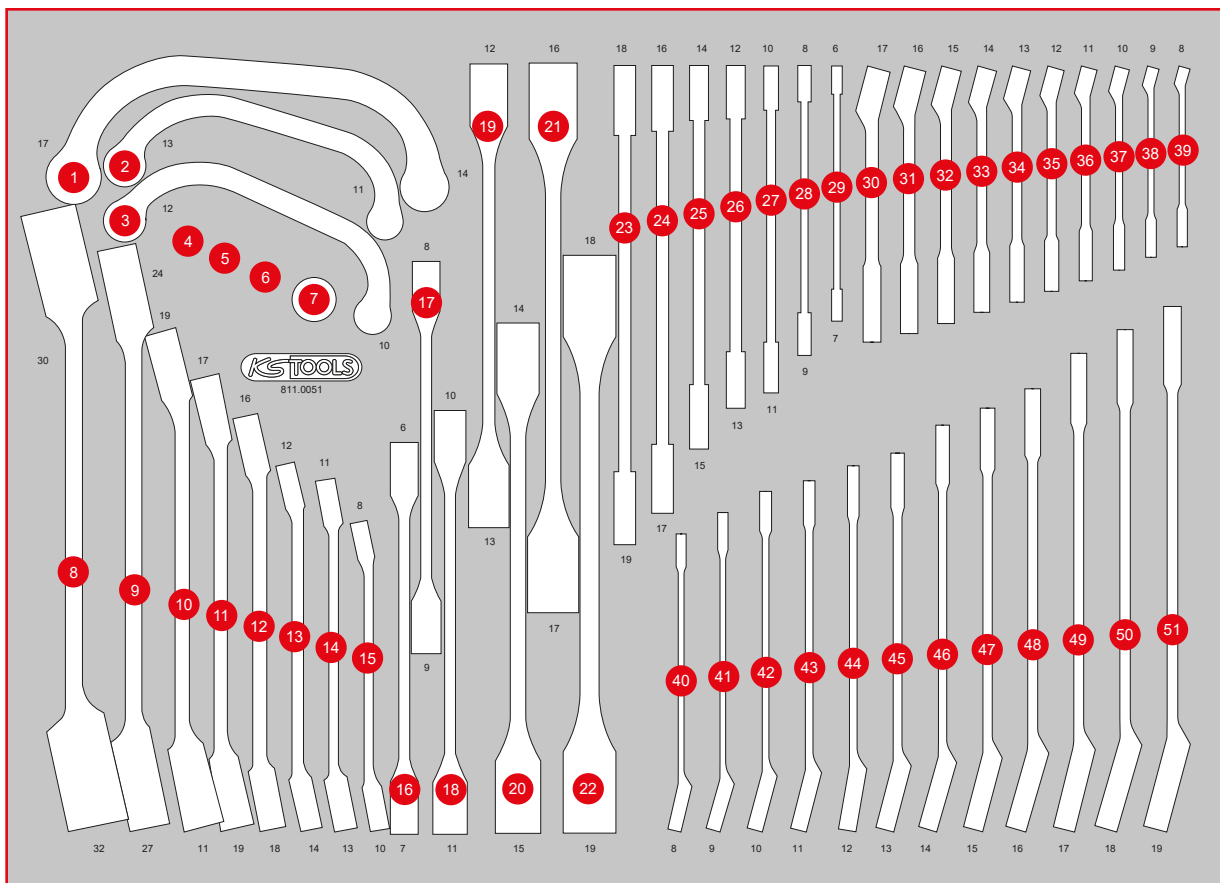

Pos.	Code	Description	pcs	Pos.	Code	Description	pcs	Pos.	Code	Description	pcs
33	518.0014	CHROMEplus Combination spanner, stubby, 14 mm	1	41	503.4609	GEARplus reversing combination ratcheting spanner, 9 mm	1	48	503.4616	GEARplus reversing combination ratcheting spanner, 16 mm	1
34	518.0013	CHROMEplus Combination spanner, stubby, 13 mm	1	42	503.4610	GEARplus reversing combination ratcheting spanner, 10 mm	1	49	503.4617	GEARplus reversing combination ratcheting spanner, 17 mm	1
35	518.0012	CHROMEplus Combination spanner, stubby, 12 mm	1	43	503.4611	GEARplus reversing combination ratcheting spanner, 11 mm	1	50	503.4618	GEARplus reversing combination ratcheting spanner, 18 mm	1
36	518.0011	CHROMEplus Combination spanner, stubby, 11 mm	1	44	503.4612	GEARplus reversing combination ratcheting spanner, 12 mm	1	51	503.4619	GEARplus reversing combination ratcheting spanner, 19 mm	1
37	518.0010	CHROMEplus Combination spanner, stubby, 10 mm	1	45	503.4613	GEARplus reversing combination ratcheting spanner, 13 mm	1				
38	518.0008	CHROMEplus Combination spanner, stubby, 9 mm	1	46	503.4614	GEARplus reversing combination ratcheting spanner, 14 mm	1				
39	518.0007	CHROMEplus Combination spanner, stubby, 8 mm	1	47	503.4615	GEARplus reversing combination ratcheting spanner, 15 mm	1				
40	503.4608	GEARplus reversing combination ratcheting spanner, 8 mm	1								

P 10

P 15

P 20

P 25

P 30

P 35

P 40

P 45

M

L

S

XL

Individual parts

Accessories

811.0053

M Screw spanner set



409, — ^{EUR}

IPCS
53

568 x 398

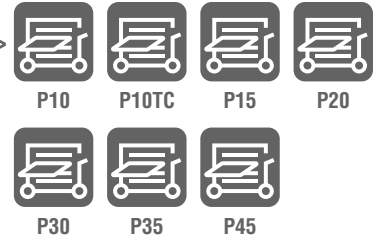

Pos.	Code	Description	pcs
1	517.0606	Combination spanners, offset, 6 mm	1
2	517.0607	Combination spanners, offset, 7 mm	1
3	517.0608	Combination spanners, offset, 8 mm	1
4	517.0609	Combination spanners, offset, 9 mm	1
5	517.0610	Combination spanners, offset, 10 mm	1
6	517.0611	Combination spanners, offset, 11 mm	1
7	517.0612	Combination spanners, offset, 12 mm	1
8	517.0613	Combination spanners, offset, 13 mm	1
9	517.0614	Combination spanners, offset, 14 mm	1
10	517.0615	Combination spanners, offset, 15 mm	1
11	517.0616	Combination spanners, offset, 16 mm	1

Pos.	Code	Description	pcs
12	517.0617	Combination spanners, offset, 17 mm	1
13	517.0618	Combination spanners, offset, 18 mm	1
14	517.0619	Combination spanners, offset, 19 mm	1
15	517.0620	Combination spanners, offset, 20 mm	1
16	517.0621	Combination spanners, offset, 21 mm	1
17	517.0622	Combination spanners, offset, 22 mm	1
18	517.0623	Combination spanners, offset, 23 mm	1
19	517.0624	Combination spanners, offset, 24 mm	1
20	911.0371	Double ring spanner for Torx E profile, E6 x E8	1
21	911.0372	Double ring spanner for Torx E profile, E7 x E11	1

Pos.	Code	Description	pcs
22	911.0373	Double ring spanner for Torx E profile, E10 x E12	1
23	911.0374	Double ring spanner for Torx E profile, E14 x E18	1
24	911.0375	Double ring spanner for Torx E profile, E16 x E22	1
25	911.0376	Double ring spanner for Torx E profile, E20 x E24	1
26	517.0252	Open double ring spanner, offset, 8 x 10 mm	1
27	517.9244	Open double ring spanner, offset, 11 x 13 mm	1
28	517.0258	Open double ring spanner, offset, 12 x 14 mm	1
29	517.0263	Open double ring spanner, offset, 16 x 18 mm	1
30	517.0264	Open double ring spanner, offset, 17 x 19 mm	1

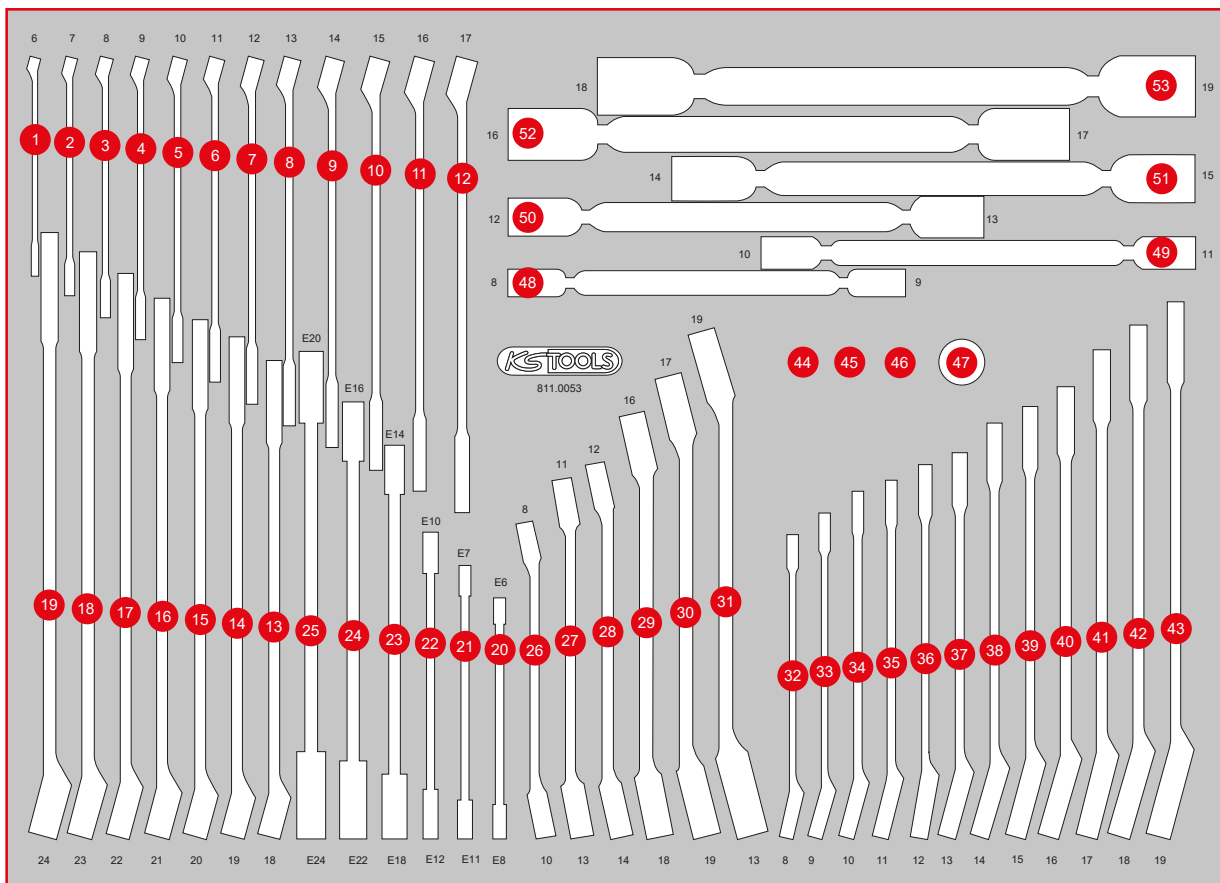

Pos.	Code	Description	pcs	Pos.	Code	Description	pcs	Pos.	Code	Description	pcs
31	517.0266	Open double ring spanner, offset, 19 x 22 mm	1	39	503.4615	GEARplus reversing combination ratcheting spanner, 15 mm	1	47	503.4298	GEARplus socket adaptor, 1/2" x 19 mm	1
32	503.4608	GEARplus reversing combination ratcheting spanner, 8 mm	1	40	503.4616	GEARplus reversing combination ratcheting spanner, 16 mm	1	48	517.0301	Double revolving head spanner, 8 x 9 mm	1
33	503.4609	GEARplus reversing combination ratcheting spanner, 9 mm	1	41	503.4617	GEARplus reversing combination ratcheting spanner, 17 mm	1	49	517.0302	Double revolving head spanner, 10 x 11 mm	1
34	503.4610	GEARplus reversing combination ratcheting spanner, 10 mm	1	42	503.4618	GEARplus reversing combination ratcheting spanner, 18 mm	1	50	517.0303	Double revolving head spanner, 12 x 13 mm	1
35	503.4611	GEARplus reversing combination ratcheting spanner, 11 mm	1	43	503.4619	GEARplus reversing combination ratcheting spanner, 19 mm	1	51	517.0304	Double revolving head spanner, 14 x 15 mm	1
36	503.4612	GEARplus reversing combination ratcheting spanner, 12 mm	1	44	503.4290	GEARplus bit adaptor, 1/4" x 10mm	1	52	517.0305	Double revolving head spanner, 16 x 17 mm	1
37	503.4613	GEARplus reversing combination ratcheting spanner, 13 mm	1	45	503.4296	GEARplus socket adaptor, 1/4" x 10 mm	1	53	517.0306	Double revolving head spanner, 18 x 19 mm	1
38	503.4614	GEARplus reversing combination ratcheting spanner, 14 mm	1	46	503.4297	GEARplus socket adaptor, 3/8" x 13 mm	1				

P 10
P 15
P 20
P 25
P 30
P 35
P 40
P 45
Individual parts S XL L M
Accessories



BLAN

KSTOOLS

BLANCPAIN
33

KSTOOLS

PIRELLI



**SPEED IN
PERFORMANCE**

811.0031

M Screw spanner set

199,- *EUR*



Pos.	Code	Description	pcs
1	517.0895	Double ring spanner, offset, 15/16 x 1"	1
2	517.0894	Double ring spanner, offset, 13/16 x 7/8"	1
3	517.0889	Double ring spanner, offset, 11/16 x 3/4"	1
4	517.0887	Double ring spanner, offset, 9/16 x 5/8"	1
5	517.0885	Double ring spanner, offset, 1/2 x 9/16"	1
6	517.0883	Double ring spanner, offset, 3/8 x 7/16"	1
7	517.0881	Double ring spanner, offset, 1/4 x 5/16"	1
8	517.9268	CLASSIC flare nut spanner, 5/8" x 11/16"	1
9	517.9267	CLASSIC flare nut spanner, 1/2" x 9/16"	1
10	517.9266	CLASSIC flare nut spanner, 3/8" x 7/16"	1
11	517.9265	CLASSIC flare nut spanner, 1/4" x 5/16"	1
12	517.0781	Double open ended spanners, 1/4 x 5/16"	1
13	517.0783	Double open ended spanners, 3/8 x 7/16"	1
14	517.0785	Double open ended spanners, 1/2 x 9/16"	1
15	517.0788	Double open ended spanners, 5/8 x 11/16"	1
16	517.0789	Double open ended spanners, 11/16 x 3/4"	1
17	517.0794	Double open ended spanners, 13/16 x 7/8"	1
18	517.0795	Double open ended spanners, 15/16 x 1"	1
19	517.0774	Double open ended spanners, 1.1/8" x 1.1/4"	1
20	517.1901	Combination spanners, offset, 1/4"	1
21	517.1902	Combination spanners, offset, 5/16"	1
22	517.1903	Combination spanners, offset, 3/8"	1
23	517.1904	Combination spanners, offset, 7/16"	1
24	517.1951	Combination spanners, offset, 1/2"	1
25	517.1906	Combination spanners, offset, 9/16"	1
26	517.1907	Combination spanners, offset, 5/8"	1
27	517.1908	Combination spanners, offset, 11/16"	1
28	517.1909	Combination spanners, offset, 3/4"	1
29	517.1912	Combination spanners, offset, 13/16"	1
30	517.1913	Combination spanners, offset, 7/8"	1
31	517.1914	Combination spanners, offset, 15/16"	1

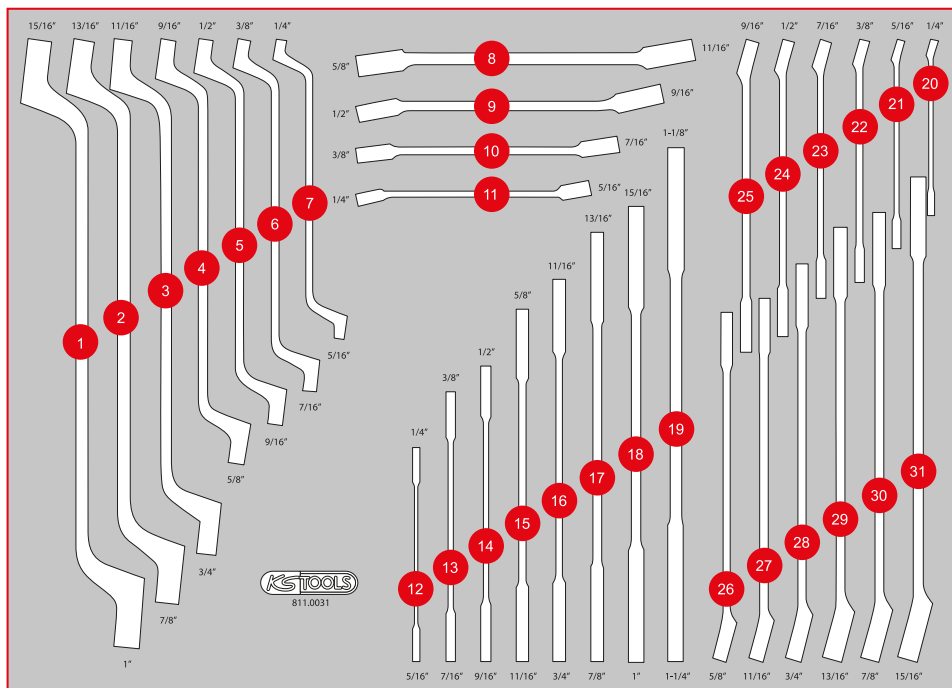

811.0012

M Spanner set

259, ^{EUR},-



568 x 398



P10



P10TC



P15



P20



P30



P35



P45



Pos.	Code	Description	pcs
1	115.1021	ERGOTORQUE combination pliers, 180 mm	1
2	115.1012	ERGOTORQUE diagonal side cutter, 160 mm	1
3	115.1019	ERGOTORQUE bent nose pliers serrated, 210 mm	1
4	115.1024	ERGOTORQUE long nose pliers serrated cutter, 200 mm	1
5	500.1026	Circlip pliers for external circlips, angled, 160 mm	1
6	500.1029	Circlip pliers for external circlips, 160 mm	1
7	500.1032	Circlip pliers for internal circlips, angled, 160 mm	1
8	500.1035	Circlip pliers for internal circlips, 160 mm	1
9	115.1031	Locking pliers, 50 mm, 140 mm	1
10	115.1035	Longbacken-Locking pliers, 210 mm	1
11	115.1033	Self grip wrench, 220 mm	1
12	115.2010	Water pump pliers, 240 mm	1

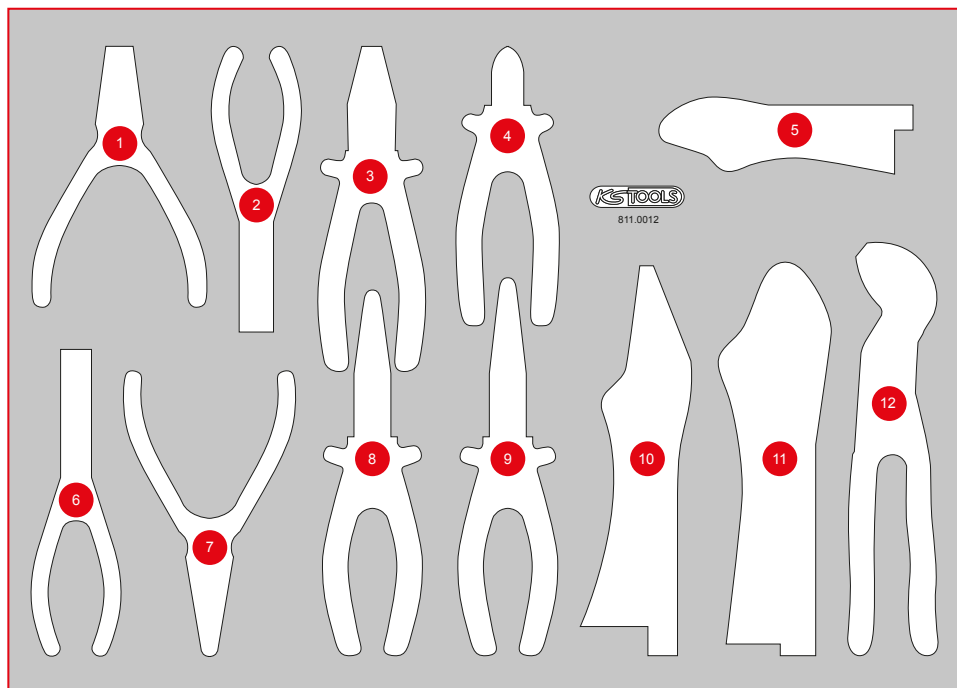

P 10

P 15

P 20

P 25

P 30

P 35

P 40

P 45

M

L

S

Individual parts

Accessories

811.0017

M Pliers, hammer and chisel set

259, ^{EUR}—



Pos.	Code	Description	pcs
1	157.0205	Round file, form F, cut 2, 200 mm	1
2	157.0005	Flat file, form B, cut 2, 200 mm	1
3	157.0405	Tri-bastard file, form C, cut 2, 200 mm	1
4	157.0105	Halfround file, form E, cut 2, 20 mm	1
5	156.0241	Flat chisel, octagon, 20 mm	1
6	156.0254	Flat chisel, octagon, 18 mm	1
7	201.2335	Steel wire brake saddle brush, 2-row, straight	1
8	115.1012	ERGOTORQUE diagonal side cutter, 160 mm	1
9	115.1021	ERGOTORQUE combination pliers, 180 mm	1
10	300.0114	Tape measure with locking device and belt clip, black red, 5 m, 19 mm	1
11	142.1402	Fitters hammer, fibreglas handle, 400 g	1
12	115.1019	ERGOTORQUE bent nose pliers serrated, 210 mm	1
13	115.1024	ERGOTORQUE long nose pliers serrated cutter, 200 mm	1
14	115.2010	Water pump pliers, 240 mm	1
15	115.1033	Self grip wrench, 220 mm	1
16	142.5101	Club hammer, fibreglas handle, 1000 g	1
17	550.1001	2in1 Telescopic solenoid holder with washer jet cleaning and setting tool, 150-675 mm	1

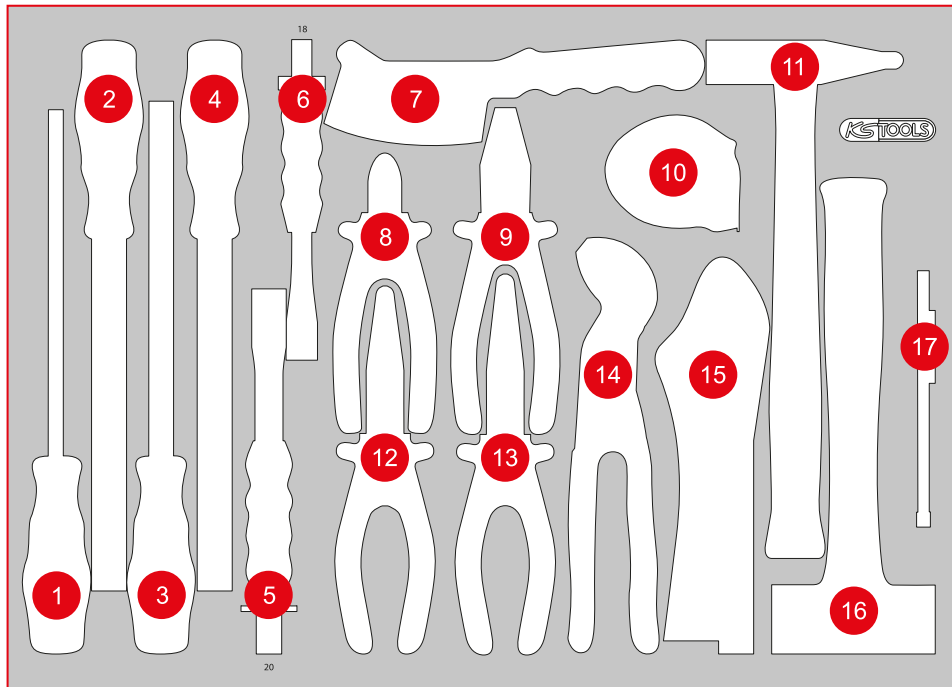

811.0020

M Hammer and chisel set

199,- EUR



568 x 398

P10

P10TC

P15

P20

P30

P35

P45



Pos.	Code	Description	pcs
1	156.0236	Pin punch, Ø 2mm, cylindrical shaft	1
2	156.0231	Pin punch, Ø 3 mm, cylindrical shaft	1
3	156.0232	Pin punch, Ø 4 mm, cylindrical shaft	1
4	156.0233	Pin punch, Ø 5 mm, cylindrical shaft	1
5	156.0234	Pin punch, Ø 6 mm, cylindrical shaft	1
6	156.0235	Pin punch, Ø 8 mm, cylindrical shaft	1
7	156.0237	Punch, Ø 3 mm, conical	1
8	156.0238	Punch, Ø 4 mm, conical	1
9	156.0244	Punch, Ø 5 mm, conical	1
10	156.0242	Cross chisel, octagon, 7 mm	1
11	156.0251	Flat chisel, octagon, 10 mm	1
12	156.0252	Flat chisel, octagon, 12 mm	1
13	156.0253	Flat chisel, octagon, 16 mm	1
14	156.0254	Flat chisel, octagon, 18 mm	1
15	156.0241	Flat chisel, octagon, 20 mm	1
16	140.5252	Recoil free soft faced hammer, 400 g	1
17	142.1402	Fitters hammer, fibreglas handle, 400 g	1
18	142.1321	Fitters hammer, fibreglas handle, 200 g	1
19	140.5271	Recoil free soft faced hammer, 480 g	1
20	142.5101	Club hammer, fibreglas handle, 1000 g	1

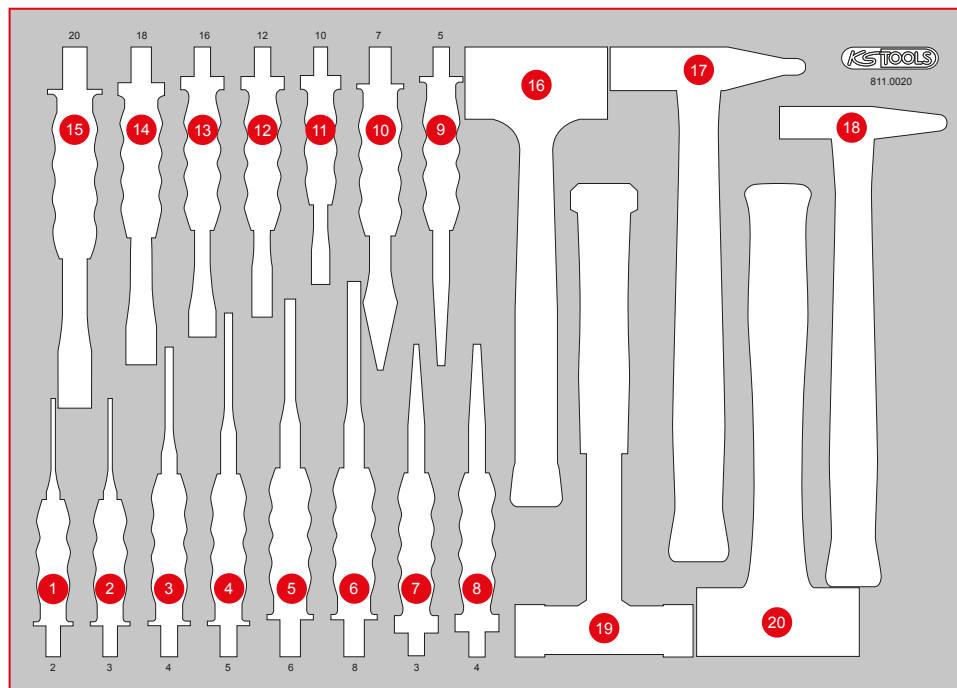

P 10

P 15

P 20

P 25

P 30

P 35

P 40

P 45

M

S

XL

Individual parts

Accessories

811.0021

M Hammer, chisel and file set

219,-^{EUR}



Pos.	Code	Description	pcs
1	140.5252	Recoil free soft faced hammer, 400 g	1
2	142.1402	Fitters hammer, fiberglas handle, 400 g	1
3	142.5101	Club hammer, fiberglas handle, 1000 g	1
4	156.0242	Cross chisel, octagon, 7 mm	1
5	156.0234	Pin punch, Ø 6 mm, cylindrical shaft	1
6	156.0233	Pin punch, Ø 5 mm, cylindrical shaft	1
7	156.0232	Pin punch, cylindrical shaft, 4 mm	1
8	156.0231	Pin punch, cylindrical shaft, 3 mm	1
9	300.0510	Pocket vernier calliper 0-150 mm, 235 mm	1
10	157.0405	Tri-bastard file, form C, cut 2, 200 mm	1
11	157.0960	Brake saddle file, extra narrow, 270 mm	1
12	157.0205	Round file, form F, cut 2, 200 mm	1
13	156.0243	Centre punch, octagon 10 mm	1
14	156.0238	Punch, Ø 4 mm, conical	1
15	156.0237	Punch, Ø 3 mm, conical	1
16	156.0252	Flat chisel, octagon, 12 mm	1
17	156.0253	Flat chisel, octagon, 16 mm	1
18	156.0254	Flat chisel, octagon, 18 mm	1
19	156.0241	Flat chisel, octagon, 20 mm	1
20	201.2335	Steel wire brake saddle brush, 2-row, straight	1
21	300.0104	Flexible steel rule, 300 mm	1

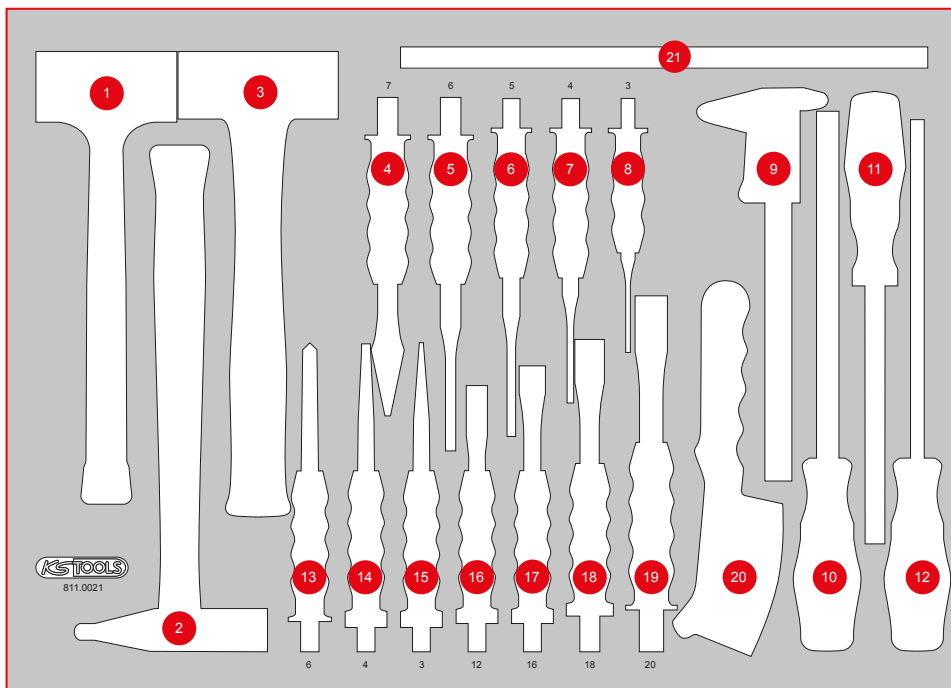

811.2022

M Pliers, hammer and chisel set

319, ^{EUR}—



Pos.	Code	Description	pcs
1	156.0237	Punch, Ø 3 mm, conical	1
2	156.0238	Punch, Ø 4 mm, conical	1
3	156.0244	Punch, Ø 5 mm, conical	1
4	156.0241	Flat chisel, octagon, 20 mm	1
5	156.0231	Pin punch, Ø 3 mm, cylindrical shaft	1
6	156.0232	Pin punch, Ø 4 mm, cylindrical shaft	1
7	156.0233	Pin punch, Ø 5 mm, cylindrical shaft	1
8	156.0234	Pin punch, Ø 6 mm, cylindrical shaft	1
9	156.0254	Flat chisel, octagon, 18 mm	1
10	500.1026	Circlip pliers for external circlips, angled, 160 mm	1
11	500.1029	Circlip pliers for external circlips, 160 mm	1
12	500.1032	Circlip pliers for internal circlips, angled, 160 mm	1
13	500.1035	Circlip pliers for internal circlips, 160 mm	1
14	115.2010	Water pump pliers, 240 mm	1
15	115.1033	Self grip wrench, 220 mm	1
16	300.0114	Tape measure with locking device and belt clip, black red, 5 m, 19 mm	1
17	115.1012	ERGOTORQUE diagonal side cutter, 160 mm	1
18	115.1019	ERGOTORQUE bent nose pliers serrated, 210 mm	1
19	115.1021	ERGOTORQUE combination pliers, 180 mm	1
20	115.1024	ERGOTORQUE long nose pliers serrated cutter, 200 mm	1
21	142.1402	Fitters hammer, fibreglas handle, 400g	1
22	142.5101	Club hammer, fibreglas handle, 1000g	1

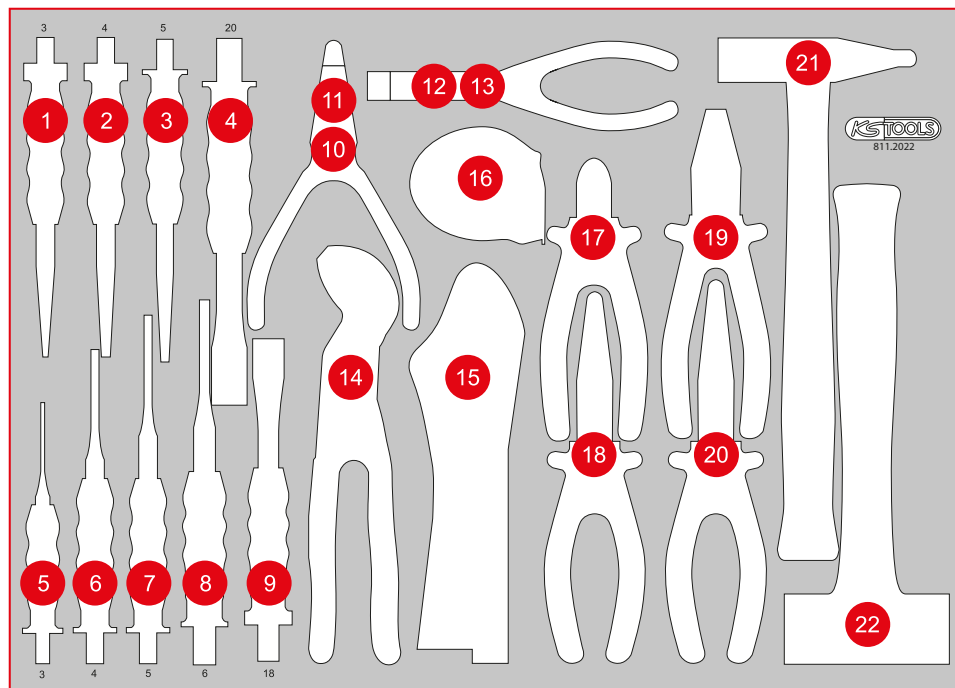

P 10
P 15
P 20
P 25
P 30
P 35
P 40
P 45
Individual parts S XL L M
Accessories

811.0022

M Hammer and chisel set

209, ^{EUR}-



Pos.	Code	Description	pcs
1	911.8138	Trim plastic wedge, 195 x 30mm	1
2	140.5252	Recoil free soft faced hammer, 400 g	1
3	142.1402	Fitters hammer, fiberglas handle, 400 g	1
4	142.5101	Club hammer, fiberglas handle, 1000 g	1
5	550.1025	Flexible magnet lifter, 510mm, Øhead=15mm	1
6	550.1001	2in1 Telescopic solenoid holder with washer jet cleaning and setting tool, 150 - 675 mm	1
7	150.4370	perfectLight torch 85 lumen	1
8	911.8146	Tyre lever, 370 mm	1
9	201.2335	Steel wire brake saddle brush, 2-row, straight 225 mm	1
10	156.0241	Flat chisel, octagon, 20 mm	1
11	156.0254	Flat chisel, octagon, 18 mm	1
12	156.0242	Cross chisel, octagon, 7 mm	1
13	156.0243	Centre punch, octagon 10 mm	1
14	156.0244	Punch, Ø 5 mm, conical	1
15	156.0238	Punch, Ø 4 mm, conical	1
16	156.0237	Punch, Ø 3 mm, conical	1
17	156.0231	Pin punch, Ø 3 mm, cylindrical shaft	1
18	156.0232	Pin punch, Ø 4 mm, cylindrical shaft	1
19	156.0233	Pin punch, Ø 5 mm, cylindrical shaft	1
20	156.0234	Pin punch, Ø 6 mm, cylindrical shaft	1
21	156.0235	Pin punch, Ø 8 mm, cylindrical shaft	1
22	907.2232	Gasket scraper, 25 x 200 mm	1

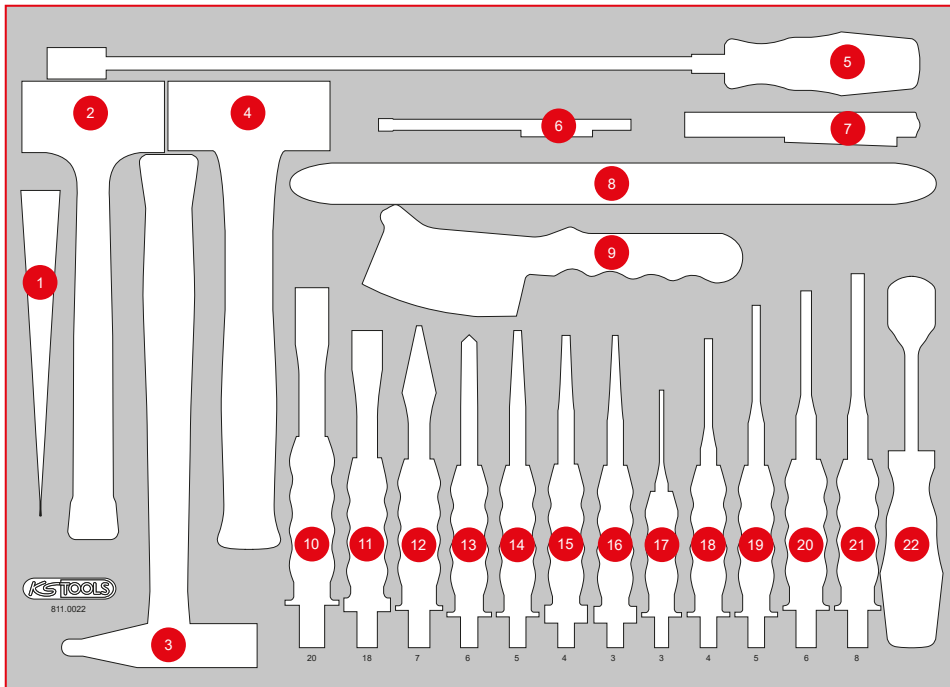

811.1023

M Pliers, hammer and chisel set

329,- EUR



568 x 398

P10

P10TC

P15

P20

P30

P35

P45



Pos.	Code	Description	pcs
1	156.0236	Pin punch, Ø 2 mm, cylindrical shaft	1
2	156.0231	Pin punch, Ø 3 mm, cylindrical shaft	1
3	156.0232	Pin punch, Ø 4 mm, cylindrical shaft	1
4	156.0233	Pin punch, Ø 5 mm, cylindrical shaft	1
5	156.0234	Pin punch, Ø 6 mm, cylindrical shaft	1
6	156.0235	Pin punch, Ø 8 mm, cylindrical shaft	1
7	156.0253	Flat chisel, octagon, 16 mm	1
8	156.0254	Flat chisel, octagon, 18 mm	1
9	156.0243	Centre punch, octagon 10 mm	1
10	156.0242	Cross chisel, octagon, 7 mm	1
11	115.1012	ERGOTORQUE diagonal side cutter, 160 mm	1
12	115.1021	ERGOTORQUE combination pliers, 180 mm	1
13	115.1024	ERGOTORQUE long nose pliers serrated cutter, 200 mm	1
14	115.1231	Multifunction pliers for insulated and non insulated cable terminals, 220 mm	1
15	115.1033	Self grip wrench, 220 mm	1
16	115.2010	Water pump pliers, 240 mm	1
17	115.1239	Self regulating wire stripper, 0,2 - 6 mm	1
18	500.1029	Circlip pliers for external circlips, 160 mm	1
19	907.2232	Gasket scraper, 25 x 200 mm	1
20	201.2320	Steel wire brake saddle wire brush 2 rowed, straight	1
21	142.1402	Fitters hammer, fibreglas handle, 400 g	1
22	140.5252	Recoil free soft faced hammer, 400 g	1
23	911.8138	Trim plastic wedge, 195 x 30mm	1

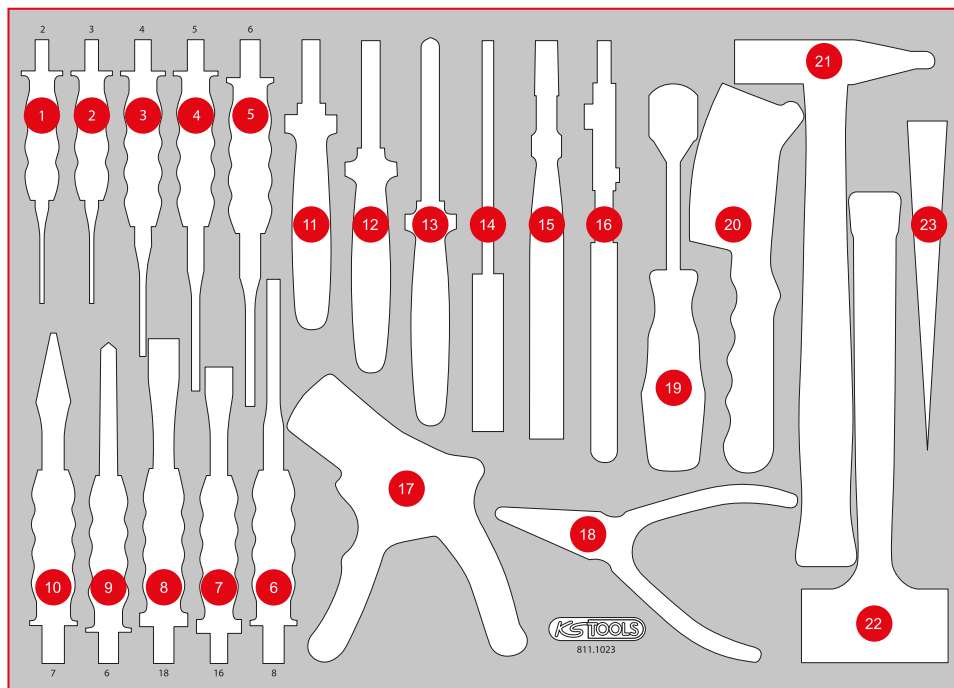

P 10

P 15

P 20

P 25

P 30

P 35

P 40

P 45

M

L

S

XL

Individual parts

Accessories

811.0019

M Pliers and file set

309, ^{EUR}—



Pos.	Code	Description	pcs
1	157.0405	Tri-bastard file, form C, cut 2, 200 mm	1
2	157.0105	Halfround file, form E, cut 2, 20 mm	1
3	157.0005	Flat file, form B, cut 2, 200 mm	1
4	157.0205	Round file, form F, cut 2, 200 mm	1
5	907.2166	Snap off blades 0,5 x1 8 x 100 mm, dispenser with 10 pieces	10
6	300.0114	Tape measure with locking device and belt clip, black red, 5 m, 19 mm	1
7	300.0510	Pocket vernier calliper 0-150 mm, 235 mm	1
8	300.0600	Feeler gauge, 20 Blades, 0,05-1 mm	1
9	907.2135	Universal snap off blade knife 18 mm	1
10	115.1033	Self grip wrench, 220 mm	1
11	115.2010	Water pump pliers, 240 mm	1
12	500.1026	Circlip pliers for external circlips, angled, 160 mm	1
13	500.1029	Circlip pliers for external circlips, 160 mm	1
14	500.1032	Circlip pliers for internal circlips, angled, 160 mm	1
15	500.1035	Circlip pliers for internal circlips, 160 mm	1
16	115.1012	ERGOTORQUE diagonal side cutter, 160 mm	1
17	115.1021	ERGOTORQUE combination pliers, 180 mm	1
18	115.1019	ERGOTORQUE bent nose pliers serrated, 210 mm	1
19	115.1024	ERGOTORQUE long nose pliers serrated cutter, 200 mm	1

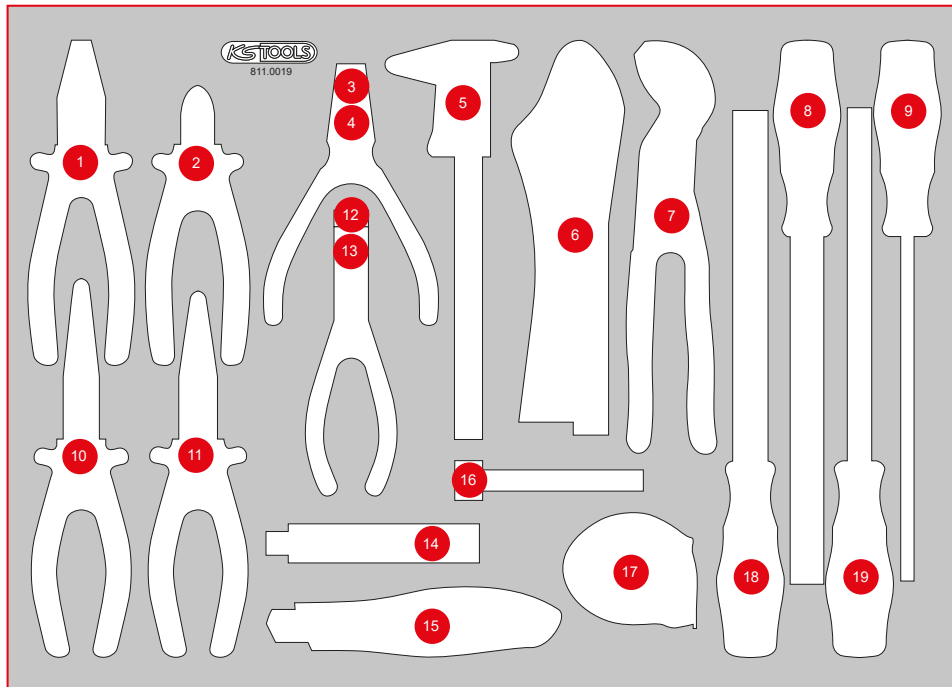

811.1032

M Screwdriver and spanner set

319,-^{EUR}

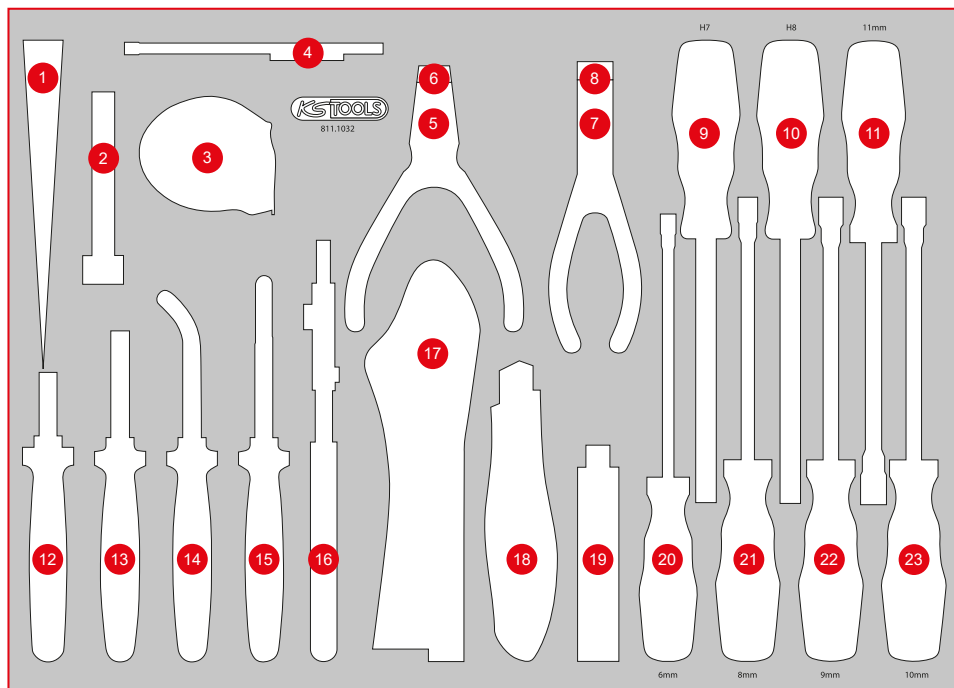

Pos.	Code	Description	pcs
1	911.8138	Trim plastic wedge, 195 x3 0mm	1
2	300.0600	Feeler gauge, 20 Blades, 0,05 - 1 mm	1
3	300.0114	Tape measure with locking device and belt clip, black red, 5 m, 19 mm	1
4	550.1001	2 in1 Telescopic solenoid holder with washer jet cleaning and setting tool, 150 - 675 mm	1
5	500.1029	Circlip pliers for external circlips, 160 mm	1
6	500.1026	Circlip pliers for external circlips, angled, 160 mm	1
7	500.1035	Circlip pliers for internal circlips, 160 mm	1
8	500.1032	Circlip pliers for internal circlips, angled, 160 mm	1
9	159.1127	ERGOTORQUEplus Socket screwdriver, 7 mm	1
10	911.1128	ERGOTORQUE Socket screwdriver, 8 mm	1
11	159.1209	ERGOTORQUEplus Socket screwdriver, 11 mm	1
12	115.1012	ERGOTORQUE diagonal side cutter, 160 mm	1
13	115.1021	ERGOTORQUE combination pliers, 180 mm	1
14	115.1019	ERGOTORQUE bent nose pliers serrated, 210 mm	1
15	115.1024	ERGOTORQUE long nose pliers serrated cutter, 200 mm	1
16	115.2010	Water pump pliers, 240 mm	1
17	115.1033	Self grip wrench, 220 mm	1
18	907.2135	Universal snap off blade knife 18 mm	1
19	907.2166	Snap off blades 0,5 x 18 x 100 mm, dispenser with 10 pieces	10
20	159.1204	ERGOTORQUEplus Socket screwdriver, 6 mm	1
21	159.1206	ERGOTORQUEplus Socket screwdriver, 8 mm	1
22	159.1207	ERGOTORQUEplus Socket screwdriver, 9 mm	1
23	159.1208	ERGOTORQUEplus Socket screwdriver, 10 mm	1

P 10

P 15

P 20

P 25

P 30

P 35

P 40

P 45

M

S

XL

L

Individual parts

Accessories

811.0033

M Pliers, hammer and chisel set

299,- *EUR*

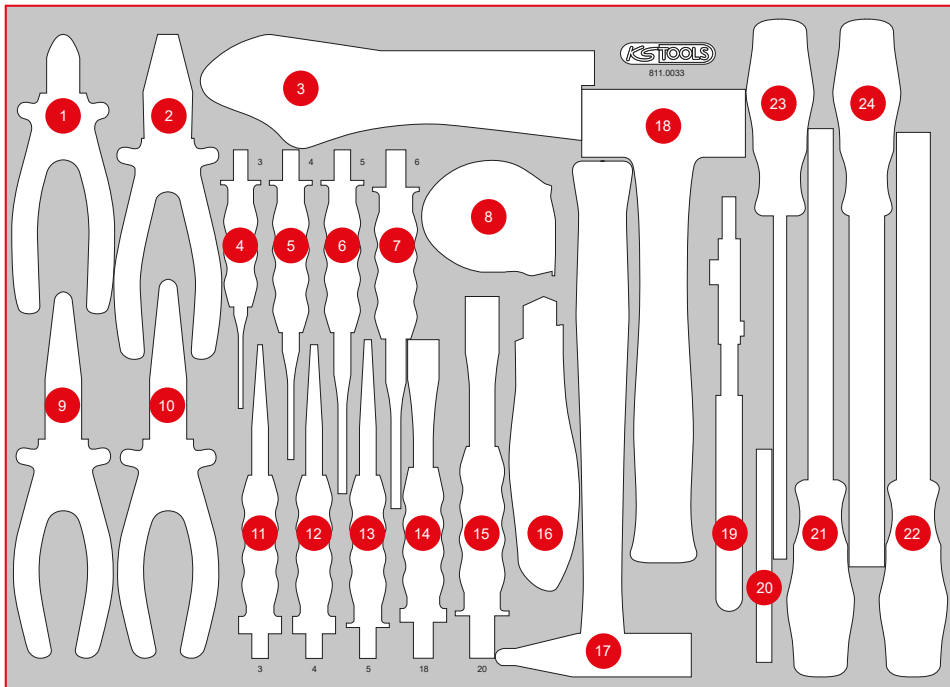

Pos.	Code	Description	pcs
1	115.1012	ERGOTORQUE diagonal side cutter, 160 mm	1
2	115.1021	ERGOTORQUE combination pliers, 180 mm	1
3	115.1033	Self grip wrench, 220 mm	1
4	156.0231	Pin punch, Ø 3 mm, cylindrical shaft	1
5	156.0232	Pin punch, Ø 4 mm, cylindrical shaft	1
6	156.0233	Pin punch, Ø 5 mm, cylindrical shaft	1
7	156.0234	Pin punch, Ø 6 mm, cylindrical shaft	1
8	300.0114	Tape measure with locking device and belt clip, black red, 5 m, 19 mm	1
9	115.1019	ERGOTORQUE bent nose pliers serrated, 210 mm	1
10	115.1024	ERGOTORQUE long nose pliers serrated cutter, 200 mm	1
11	156.0237	Punch, Ø 3 mm, conical	1
12	156.0238	Punch, Ø 4 mm, conical	1
13	156.0244	Punch, Ø 5 mm, conical	1
14	156.0254	Flat chisel, octagon, 18 mm	1
15	156.0241	Flat chisel, octagon, 20 mm	1
16	907.2135	Universal snap off blade knife 18 mm	1
17	142.1402	Fitters hammer, fibreglas handle, 400 g	1
18	142.5101	Club hammer, fibreglas handle, 1000 g	1
19	115.2010	Water pump pliers, 240 mm	1
20	907.2166	Snap off blades 0,5 x 1 8 x 100 mm, dispenser with 10 pieces	10
21	157.0405	Tri-bastard file, form C, cut 2, 200 mm	1
22	157.0105	Halfround file, form E, cut 2, 200 mm	1
23	157.0205	Round file, form F, cut 2, 200 mm	1
24	157.0005	Flat file, form B, cut 2, 200 mm	1



P 10
P 15
P 20
P 25
P 30
P 35
P 40
P 45
M
L
XL
S
Individual parts
Accessories

811.1017

M Hammer and chisel set

189, ^{EUR}—



Pos.	Code	Description	pcs
1	150.1670	Test probe 6-24V DC with 5 m cable	1
2	911.8146	Tyre lever, 370 mm	1
3	156.0243	Centre punch, octagon 10 mm	1
4	156.0242	Cross chisel, octagon, 7 mm	1
5	156.0254	Flat chisel, octagon, 18 mm	1
6	156.0241	Flat chisel, octagon, 20 mm	1
7	156.0235	Pin punch, Ø 8 mm, cylindrical shaft	1
8	156.0234	Pin punch, Ø 6 mm, cylindrical shaft	1
9	156.0233	Pin punch, Ø 5 mm, cylindrical shaft	1
10	156.0232	Pin punch, Ø 4 mm, cylindrical shaft	1
11	156.0231	Pin punch, Ø 3 mm, cylindrical shaft	1
12	907.2222	Gasket scraper, 25 x 200 mm	1
13	201.2335	Steel wire brake saddle brush, 2-row, straight 225 mm	1
14	300.0114	Tape measure with locking device and belt clip, black red, 5 m, 19 mm	1
15	142.1402	Fitters hammer, fibreglas handle, 400 g	1
16	140.5252	Recoil free soft faced hammer, 400 g	1
17	911.8138	Trim plastic wedge, 195 x30 mm	1

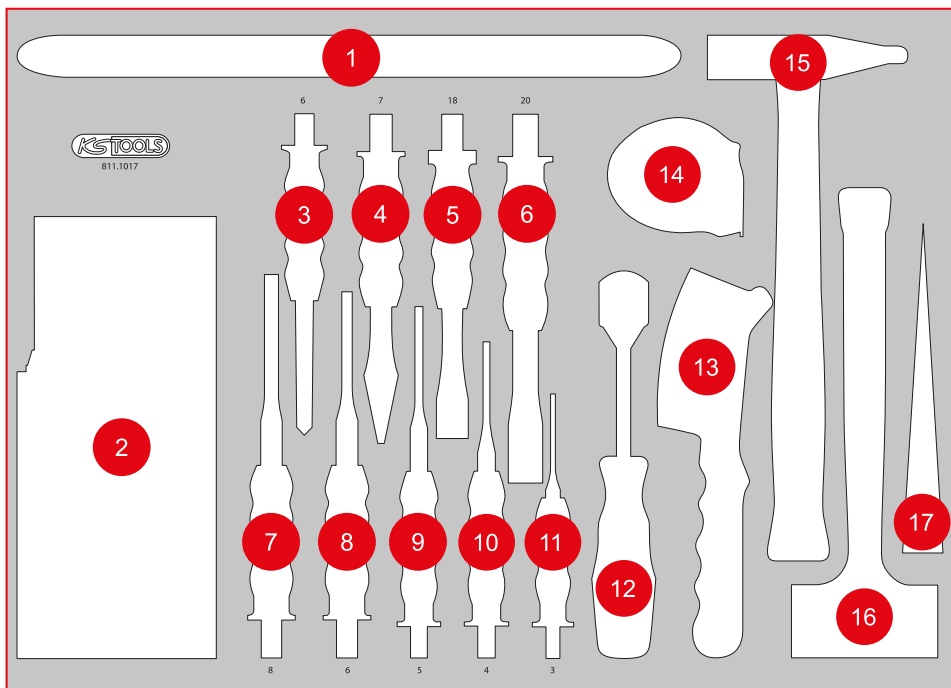



P 10
P 15
P 20
P 25
P 30
P 35
P 40
P 45
M
L
XL
S
Individual parts
Accessories

811.0043

M Oil and tyre servicing set



399, ^{EUR}—

43

568 x 398

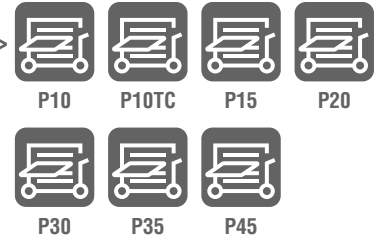

Pos.	Code	Description	pcs
1	150.2222	Brake piston reset device, 3/8"	1
2	150.9120	3/8" Oil service bit socket for internal square screws, 3/8" mm	1
3	150.9119	3/8" Oil service bit socket for internal square screws, 5/16" mm	1
4	150.9111	3/8" Oil service bit socket for internal square screws, 7 mm	1
5	150.9112	3/8" Oil service bit socket for internal square screws, 8 mm	1
6	150.9113	3/8" Oil service bit socket for internal square screws, 10 mm	1
7	150.9114	3/8" Oil service bit socket for internal square screws, 11 mm	1

Pos.	Code	Description	pcs
8	150.9116	3/8" Oil service bit socket 12 mm for internal square screws	1
9	150.9117	3/8" Oil service bit socket 13 mm for internal square screws	1
10	150.9118	3/8" Oil service bit socket 14 mm for internal square screws	1
11	150.9122	3/8" Oil service bit socket 10 mm for internal square screws	1
12	150.9121	3/8" Oil service bit socket 10 mm for internal square screws	1
13	150.9123	3/8" Oil service bit socket 8 mm for internal square screws	1

Pos.	Code	Description	pcs
14	150.9124	3/8" Oil service bit socket 9 mm for internal square screws	1
15	150.9125	3/8" Oil service bit socket 10 mm for internal square screws	1
16	150.9126	3/8" Oil service bit socket 12 mm for internal square screws	1
17	150.9127	3/8" Oil service bit socket 14 mm for internal square screws	1
18	150.9128	3/8" Oil service bit socket 17 mm for internal square screws	1
19	150.2153	1/2" Brake calliper bit socket, pentagon, 10 mm	1
20	150.2154	1/2" Brake calliper socket, pentagon, 14 mm	1

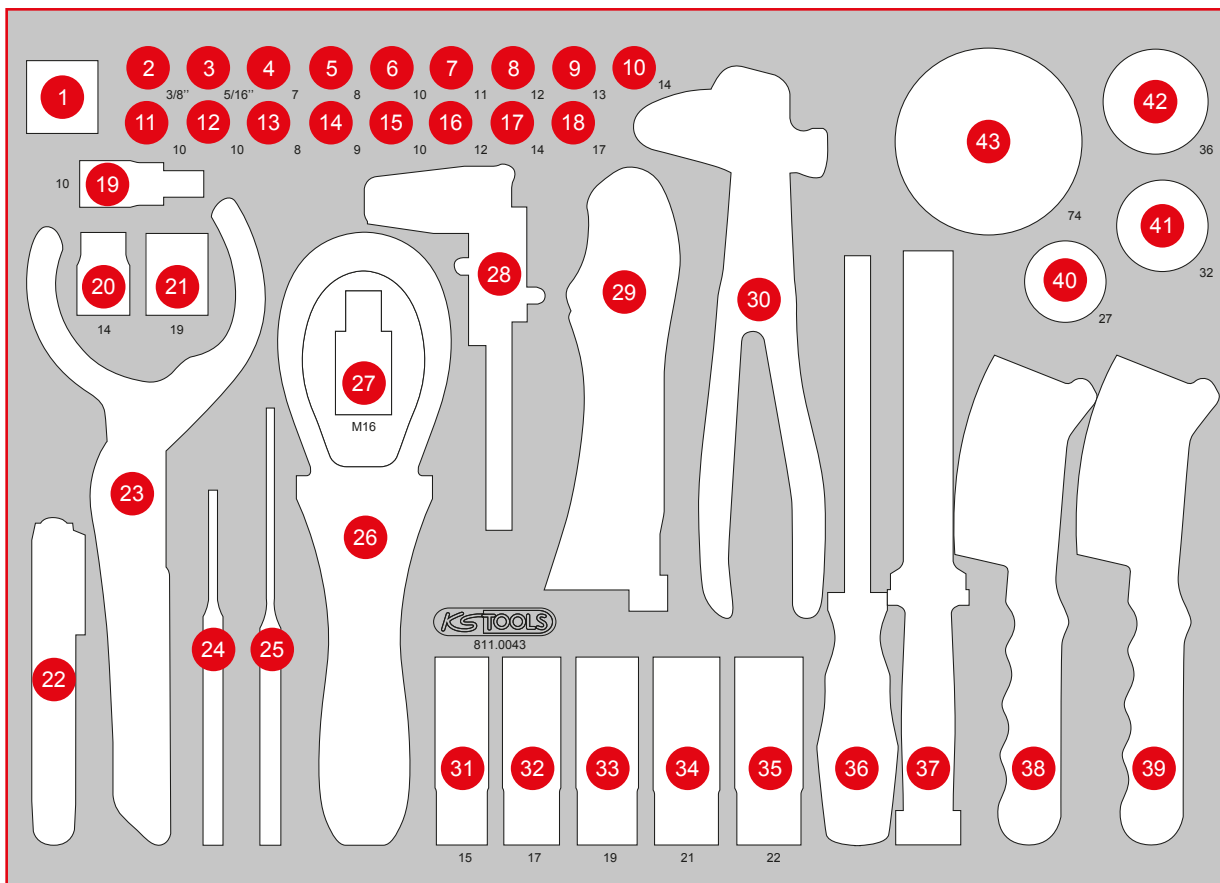

Pos.	Code	Description	pcs	Pos.	Code	Description	pcs	Pos.	Code	Description	pcs
21	150.2155	1/2" Brake calliper socket, pentagon, 19 mm	1	29	115.1175	Round jaw-American type, 175 mm	1	36	157.0960	Brake saddle file, extra narrow, 270 mm	1
22	150.2199	Brake fluid tester	1	30	150.2025	Wheel balance weight pliers, 250 mm	1	37	911.8132	Glass fibre chisel, 22 mm	1
23	150.9317	Oil filter pliers, 50-125 mm	1	31	515.0991	SlimPOWER 1/2"Alloy rim impact socket, 15 mm	1	38	201.2335	Steel wire brake saddle brush, 2-row, straight	1
24	156.0114	Pin punch octagonal shaft, mirror polished, Ø 5mm	1	32	515.0992	SlimPOWER 1/2"Alloy rim impact socket, 17mm	1	39	201.2340	Brass wire brake saddle brush, 2-row, curved	1
25	156.0122	Pin punch octagonal shaft, mirror polished, extra long, Ø 4mm	1	33	515.0993	SlimPOWER 1/2"Alloy rim impact socket, 19 mm	1	40	150.9217	3/8" Universal Oil filter band wrench, SW 27 mm	1
26	155.5005	Oil filter band wrench, Ø 65-105 mm	1	34	515.0994	SlimPOWER 1/2"Alloy rim impact socket, 21 mm	1	41	150.9218	3/8" Universal Oil filter band wrench, SW 32 mm	1
27	911.1348	1/2" Bit socket spline (XZN) tamperproof, M16, 55 mm	1	35	515.0995	SlimPOWER 1/2"Alloy rim impact socket, 22 mm	1	42	150.9219	3/8" Universal Oil filter band wrench, SW 36 mm	1
28	300.0535	Brake disk vernier calliper, 0-60 mm, 162 mm	1					43	150.9215	3/8" Oil filter wrench, 74,2mm, 14 grooves	1

P 10
P 15
P 20
P 25
P 30
P 35
P 40
P 45
Accessories Individual parts S XL L M

811.0028

M Measuring tool and file set

189, ^{EUR}—



Pos.	Code	Description	pcs
1	300.0104	Flexible steel rule, 300 mm	1
2	300.0700	Protractor with rule, 220 mm	1
3	156.0466	Automatic centre punch, Ø 4 mm	1
4	300.0510	Pocket vernier calliper 0 - 150 mm, 235 mm	1
5	300.0600	Feeler gauge, 20 Blades, 0,05 - 1 mm	1
6	201.2335	Steel wire brake saddle brush, 2-row, straight 225 mm	1
7	300.0550	Digital depth gauge 0-25 mm, 125 mm	1
8	300.0114	Tape measure with locking device and belt clip, black red, 5 m, 19 mm	1
9	157.0105	Halfround file, form E, cut 2, 20 mm	1
10	157.0205	Round file, form F, cut 2, 200 mm	1
11	157.0005	Flat file, form B, cut 2, 200 mm	1
12	157.0405	Tri-bastard file, form C, cut 2, 200 mm	1
13	157.0960	Brake saddle file, extra narrow, 270 mm	1
14	911.8138	Trim plastic wedge, 195 mm x B = 30 mm	1
15	907.2115	Hacksaw frame, 300 mm	1
16	907.2166	Snap off blades 0,5 x 1,8 x 100 mm, dispenser with 10 pieces	10
17	907.2135	Universal snap off blade knife 18 mm	1
18	129.6620-24	HSS Bi Co 8 metal high performance saw blades 1,0mm	1
19	911.8146	Tyre lever, 370 mm	1

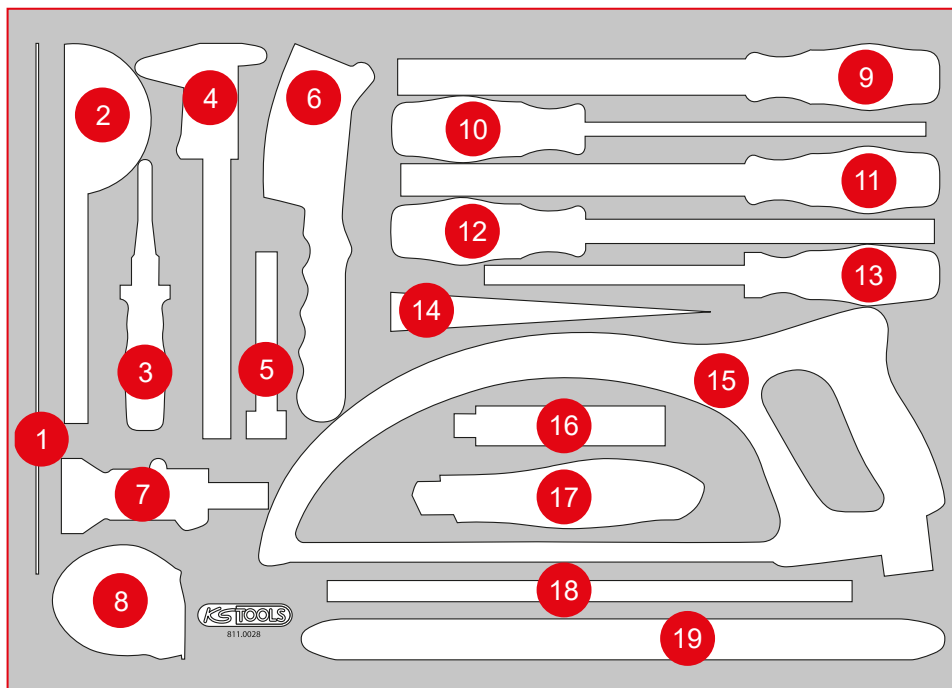



P 10

P 15

P 20

P 25

P 30

P 35

P 40

P 45

M

L

S

XL

Individual parts

Accessories

813.0146

L 1/4" Socket spanner and screwdriver set

339, — ^{EUR}

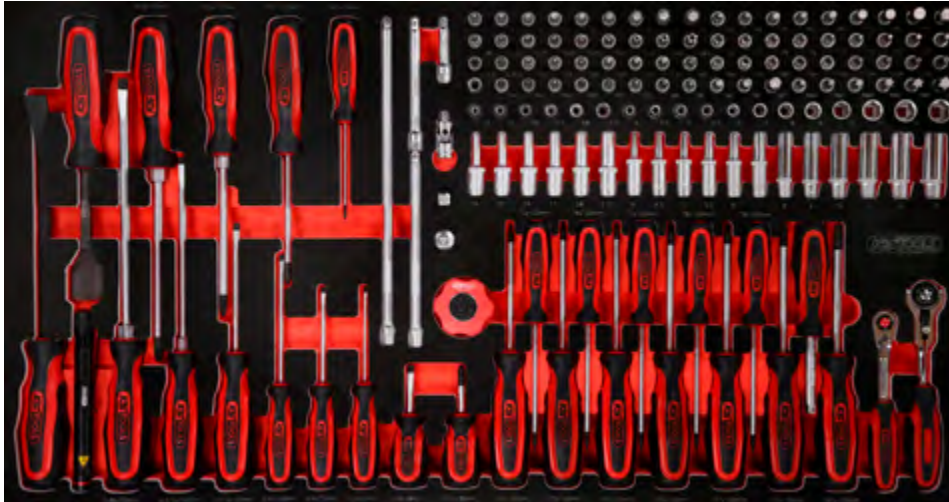

146 PCS

755 x 398 P25

Pos.	Code	Description	pcs	Pos.	Code	Description	pcs	Pos.	Code	Description	pcs
1	911.8102	Pry bar, 15 x 185 mm	1	21	911.3897	3/8" Reducing adaptor, 3/8"F x 1/4"M	1	50	911.4407	1/4" Bit socket Torx, T6	1
2	159.1024	ERGOTORQUEplus screwdriver, Torx, PH3, 265 mm	1	22	914.1410	Mini hand reversible ratchet, 1/4", 72 teethh	1	51	911.4362	1/4" Bit socket Torx, T7	1
3	159.1022	ERGOTORQUEplus screwdriver, Torx, PH2, 230 mm	1	23	917.2443	Hex bit socket,ball ended,1/4", 3 mm	1	52	911.1448	1/4" Bit socket Torx, T8	1
4	159.1029	ERGOTORQUEplus screwdriver, Torx, PH1, 205 mm	1	24	917.2444	Hex bit socket,ball ended,1/4", 4 mm	1	53	911.1478	1/4" Bit socket Torx, T9	1
5	159.1027	ERGOTORQUEplus screwdriver, Torx, PH0, 155 mm	1	25	917.2445	Hex bit socket,ball ended,1/4", 5 mm	1	54	911.1442	1/4" Bit socket Torx, T10	1
6	911.8103	Pry bar, 18 x 320 mm	1	26	917.24455	Hex bit socket,ball ended,1/4", 5,5 mm	1	55	911.1443	1/4" Bit socket Torx, T15	1
7	159.1011	ERGOTORQUEplus screwdriver for slotted screws, 8 mm, 315 mm long	1	27	917.2446	Hex bit socket,ball ended,1/4", 6 mm	1	56	911.1444	1/4" Bit socket Torx, T20	1
8	159.1009	ERGOTORQUEplus screwdriver for slotted screws, 6,5 mm, 255 mm long	1	28	917.2447	Hex bit socket,ball ended,1/4", 7 mm	1	57	911.1445	1/4" Bit socket Torx, T25	1
9	159.1006	ERGOTORQUEplus screwdriver for slotted screws, 5,5 mm, 230 mm long	1	29	917.2448	Hex bit socket,ball ended,1/4", 8 mm	1	58	911.1449	1/4" Bit socket Torx, T27	1
10	159.1004	ERGOTORQUEplus screwdriver for slotted screws, 4 mm, 180 mm long	1	30	917.2449	Hex bit socket,ball ended,1/4", 9 mm	1	59	911.1419	1/4" Bit socket slot, 5,5 mm	1
11	159.1003	ERGOTORQUEplus screwdriver for slotted screws, 4 mm, 155 mm long	1	31	917.2450	Hex bit socket,ball ended,1/4", 10 mm	1	60	917.1421	1/4" Bit socket slot, 6,5 mm	1
12	159.1002	ERGOTORQUEplus screwdriver for slotted screws, 3 mm, 155 mm long	1	32	911.1436	1/4" Bit socket hexagon, 3 mm	1	61	911.3771	1/4" Bit socket Torx, ball ended, T10	1
13	159.1001	ERGOTORQUEplus screwdriver for slotted screws, short, 6 mm	1	33	911.1437	1/4" Bit socket hexagon, 4 mm	1	62	911.3772	1/4" Bit socket Torx, ball ended, T15	1
14	159.1141	ERGOTORQUEplus screwdriver, Torx, short, PH1	1	34	911.1438	1/4" Bit socket hexagon, 5 mm	1	63	911.3773	1/4" Bit socket Torx, ball ended, T20	1
15	911.1543	1/4" Wobble extension with hexagon drive, 250 mm	1	35	911.14385	1/4" Bit socket hexagon, 5,5 mm	1	64	911.3774	1/4" Bit socket Torx, ball ended, T25	1
16	911.1424	1/4" Extension with hexagon drive, 100 mm	1	36	911.1439	1/4" Bit socket hexagon, 6 mm	1	65	911.3775	1/4" Bit socket Torx, ball ended, T27	1
17	911.1451	1/4" Extension with hexagon drive, 150 mm	1	37	911.1440	1/4" Bit socket hexagon, 7 mm	1	66	911.3776	1/4" Bit socket Torx, ball ended, T30	1
18	911.1423	1/4" Extension with hexagon drive, 50 mm	1	38	911.1441	1/4" Bit socket hexagon, 8 mm	1	67	911.3777	1/4" Bit socket Torx, ball ended, T40	1
19	911.1450	1/4" Universal joint	1	39	917.1454	1/4" Bit socket hexagon, 9 mm	1	68	917.1456	1/4" Bit socket Torx tamperproof, TB6	1
20	911.1494	1/4" Adaptor, 1/4"F x 3/8"M	1	40	917.1452	1/4" Bit socket hexagon, 10 mm	1	69	917.1457	1/4" Bit socket Torx tamperproof, TB7	1
				41	917.1578	1/4" Torx Plus Bit-Socket 8IPR	1	70	911.1461	1/4" Bit socket Torx tamperproof, TB8	1
				42	911.1701	1/4" Bit socket five star tamperproof, TS10	1	71	911.1485	1/4" Bit socket Torx tamperproof, TB9	1
				43	911.1702	1/4" Bit socket five star tamperproof, TS15	1	72	911.1462	1/4" Bit socket Torx tamperproof, TB10	1
				44	911.1703	1/4" Bit socket five star tamperproof, TS20	1	73	911.1463	1/4" Bit socket Torx tamperproof, TB15	1
				45	911.1704	1/4" Bit socket five star tamperproof, TS25	1	74	911.1464	1/4" Bit socket Torx tamperproof, TB20	1
				46	911.1705	1/4" Bit socket five star tamperproof, TS27	1	75	911.1465	1/4" Bit socket Torx tamperproof, TB25	1
				47	911.1706	1/4" Bit socket five star tamperproof, TS30	1	76	911.1466	1/4" Bit socket Torx tamperproof, TB27	1
				48	911.1707	1/4" Bit socket five star tamperproof, TS40	1	78	911.1482	1/4" Bit socket, PH0	1
				49	911.1708	1/4" Bit socket five star tamperproof, TS45	1	79	911.1415	1/4" Bit socket, PH1	1
								80	911.1416	1/4" Bit socket, PH2	1

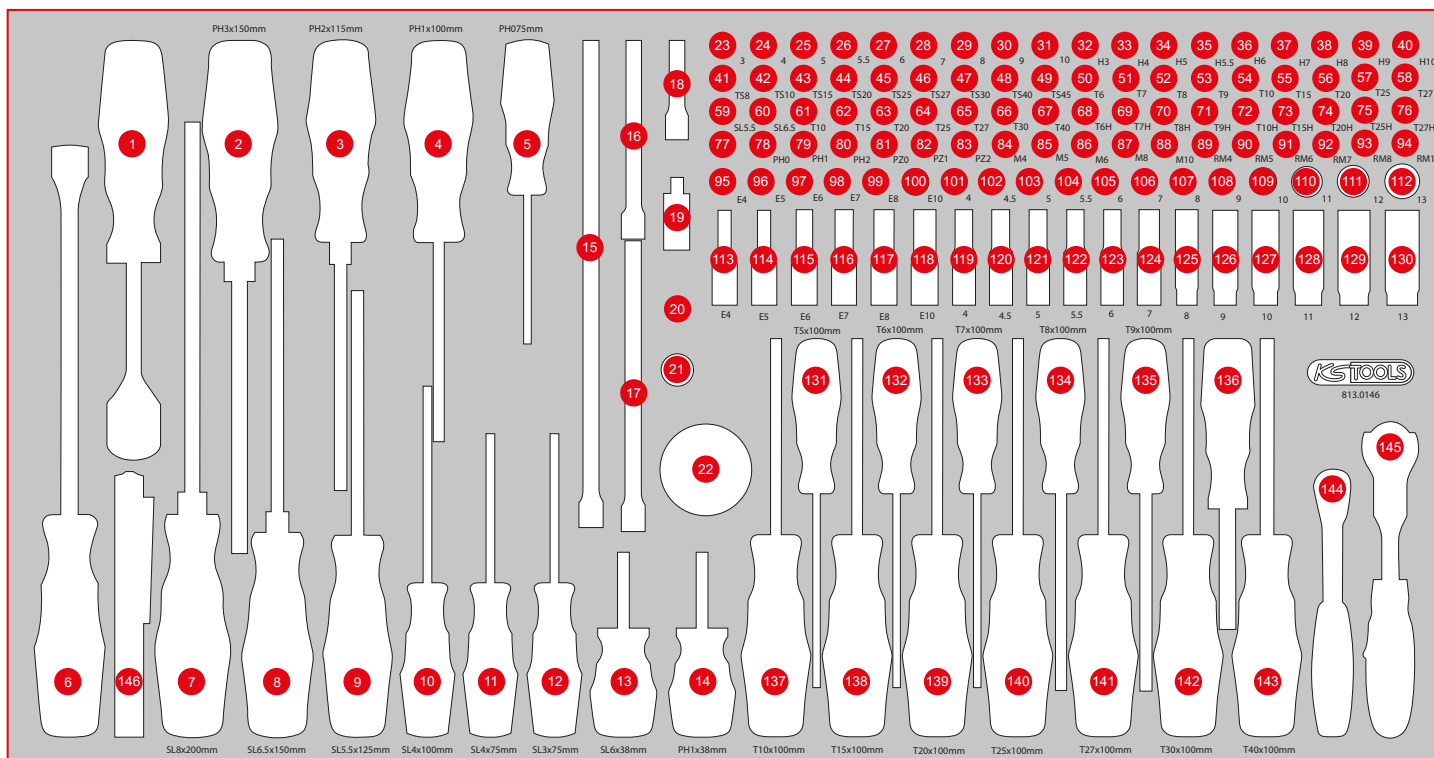

Pos.	Code	Description	pcs	Pos.	Code	Description	pcs	Pos.	Code	Description	pcs
81	911.1483	1/4" Bit socket, PZ0	1	109	917.1410	1/4" Hexagonal socket, 10 mm	1	138	159.1033	ERGOTORQUEplus screwdriver, Torx, T15	1
82	911.1401	1/4" Bit socket, PZ1	1	110	917.1411	1/4" Hexagonal socket, 11 mm	1	139	159.1034	ERGOTORQUEplus screwdriver, Torx, T20	1
83	911.1402	1/4" Bit socket, PZ2	1	111	917.1412	1/4" Hexagonal socket, 12 mm	1	140	159.1035	ERGOTORQUEplus screwdriver, Torx, T25	1
84	917.1541	1/4" Bit socket spline (XZN), M4	1	112	917.1413	1/4" Hexagonal socket, 13 mm	1	141	159.1036	ERGOTORQUEplus screwdriver, Torx, T27	1
85	917.1542	1/4" Bit socket spline (XZN), M5	1	113	917.2401	1/4" Torx E Socket, deep, E4	1	142	159.1037	ERGOTORQUEplus screwdriver, Torx, T30	1
86	917.1543	1/4" Bit socket spline (XZN), M6	1	114	917.2402	1/4" Torx E Socket, deep, E5	1	143	159.1038	ERGOTORQUEplus screwdriver, Torx, T40	1
87	917.1545	1/4" Bit socket spline (XZN), M8	1	115	917.2403	1/4" Torx E Socket, deep, E6	1	144	920.1490	1/4" SlimPOWER Reversible ratchet, 72 teeth	1
88	917.1546	1/4" Bit socket spline (XZN), M10	1	116	917.2404	1/4" Torx E Socket, deep, E7	1	145	914.1405	1/4" MODIFIX mini T-handle swivel head ratchet, 72 teeth	1
89	917.1584	1/4" RIBE Socket M4S	1	117	917.2405	1/4" Torx E Socket, deep, E8	1	146	150.4370	perfectLight torch 85 lumen	1
90	917.1585	1/4" RIBE Socket M5S	1	118	917.2406	1/4" Torx E Socket, deep, E10	1				
91	917.1586	1/4" RIBE Socket M6S	1	119	917.1525	1/4" Hexagonal socket, deep, 4 mm	1				
92	917.1587	1/4" RIBE Socket M7S	1	120	917.1526	1/4" Hexagonal socket, deep, 4,5 mm	1				
93	917.1588	1/4" RIBE Socket M8S	1	121	917.1527	1/4" Hexagonal socket, deep, 5 mm	1				
94	917.1590	1/4" RIBE Socket M10S	1	122	917.1528	1/4" Hexagonal socket, deep, 5,5 mm	1				
95	911.4313	1/4" Torx E Socket, E4	1	123	917.1426	1/4" Hexagonal socket, deep, 6 mm	1				
95	911.0101	1/4" socket with magnet	1	124	917.1427	1/4" Hexagonal socket, deep, 7 mm	1				
96	911.4314	1/4" Torx E Socket, E5	1	125	917.1428	1/4" Hexagonal socket, deep, 8 mm	1				
97	911.4315	1/4" Torx E Socket, E6	1	126	917.1429	1/4" Hexagonal socket, deep, 9 mm	1				
98	911.4316	1/4" Torx E Socket, E7	1	127	917.1430	1/4" Hexagonal socket, deep, 10 mm	1				
99	911.4317	1/4" Torx E Socket, E8	1	128	917.1431	1/4" Hexagonal socket, deep, 11 mm	1				
100	911.4332	1/4" Torx E Socket, E10	1	129	917.1432	1/4" Hexagonal socket, deep, 12 mm	1				
101	917.1404	1/4" Hexagonal socket, 4 mm	1	130	917.1433	1/4" Hexagonal socket, deep, 13 mm	1				
102	917.14045	1/4" Hexagonal socket, 4,5 mm	1	131	159.1133	ERGOTORQUEplus screwdriver, Torx, T5	1				
103	917.1405	1/4" Hexagonal socket, 5 mm	1	132	159.1134	ERGOTORQUEplus screwdriver, Torx, T6	1				
104	917.14055	1/4" Hexagonal socket, 5,5 mm	1	133	159.1135	ERGOTORQUEplus screwdriver, Torx, T7	1				
105	917.1406	1/4" Hexagonal socket, 6 mm	1	134	159.1030	ERGOTORQUEplus screwdriver, Torx, T8	1				
106	917.1407	1/4" Hexagonal socket, 7 mm	1	135	159.1031	ERGOTORQUEplus screwdriver, Torx, T9	1				
107	917.1408	1/4" Hexagonal socket, 8 mm	1	136	911.1434	1/4" Square drive screwdriver, 150 mm	1				
108	917.1409	1/4" Hexagonal socket, 9 mm	1	137	159.1032	ERGOTORQUEplus screwdriver, Torx, T10	1				

P 10
P 15
P 20
P 25
P 30
P 35
P 40
P 45
Individual parts
Accessories

813.0183

L 1/4" + 3/8" Socket spanner set

519,^{EUR}-



183

755 x 398 **P25**

Pos.	Code	Description	pcs	Pos.	Code	Description	pcs	Pos.	Code	Description	pcs
1	917.4831	3/8" 12 Point socket, deep, 6 mm	1	31	911.3984	3/8" 12 Point socket, 11 mm	1	61	917.3812	3/8" Hexagonal socket, 12 mm	1
2	917.4832	3/8" 12 Point socket, deep, 7 mm	1	32	911.3985	3/8" 12 Point socket, 12 mm	1	62	917.3813	3/8" Hexagonal socket, 13 mm	1
3	917.3855	3/8" 12 Point socket, deep, 8 mm	1	33	911.3986	3/8" 12 Point socket, 13 mm	1	63	917.3814	3/8" Hexagonal socket, 14 mm	1
4	917.3856	3/8" 12 Point socket, deep, 9 mm	1	34	911.3987	3/8" 12 Point socket, 14 mm	1	64	917.3815	3/8" Hexagonal socket, 15 mm	1
5	917.3970	3/8" 12 Point socket, deep, 10 mm	1	35	911.3988	3/8" 12 Point socket, 15 mm	1	65	917.3816	3/8" Hexagonal socket, 16 mm	1
6	917.3971	3/8" 12 Point socket, deep, 11 mm	1	36	911.3989	3/8" 12 Point socket, 16 mm	1	66	917.3817	3/8" Hexagonal socket, 17 mm	1
7	917.3972	3/8" 12 Point socket, deep, 12 mm	1	37	911.3992	3/8" 12 Point socket, 17 mm	1	67	917.3818	3/8" Hexagonal socket, 18 mm	1
8	917.3973	3/8" 12 Point socket, deep, 13 mm	1	38	911.3994	3/8" 12 Point socket, 19 mm	1	68	917.3819	3/8" Hexagonal socket, 19 mm	1
9	917.3974	3/8" 12 Point socket, deep, 14 mm	1	39	911.3996	3/8" 12 Point socket, 21 mm	1	69	911.3865	3/8" Bit socket hexagon, 5 mm	1
10	917.3975	3/8" 12 Point socket, deep, 15 mm	1	40	911.4342	3/8" Torx E Socket, E8	1	70	911.38655	3/8" Bit socket hexagon, 5,5 mm	1
11	917.3976	3/8" 12 Point socket, deep, 16 mm	1	41	911.4318	3/8" Torx E Socket, E10	1	71	911.3866	3/8" Bit socket hexagon, 6 mm	1
12	917.3977	3/8" 12 Point socket, deep, 17 mm	1	42	911.4319	3/8" Torx E Socket, E11	1	72	911.3867	3/8" Bit socket hexagon, 7 mm	1
13	917.3978	3/8" 12 Point socket, deep, 18 mm	1	43	911.4320	3/8" Torx E Socket, E12	1	73	911.3868	3/8" Bit socket hexagon, 8 mm	1
14	917.3979	3/8" 12 Point socket, deep, 19 mm	1	44	911.4321	3/8" Torx E Socket, E14	1	74	917.3969	3/8" Bit socket hexagon, 9 mm	1
15	917.4851	3/8" 12-edge socket with joint, 10 mm	1	45	911.4343	3/8" Torx E Socket, E16	1	75	917.3857	3/8" Bit socket hexagon, 10 mm	1
16	917.4852	3/8" 12-edge socket with joint, 11 mm	1	46	911.4344	3/8" Torx E Socket, E18	1	76	911.3862	3/8" Bit socket hexagon, 12 mm	1
17	917.4853	3/8" 12-edge socket with joint, 12 mm	1	47	911.4345	3/8" Torx E Socket, E20	1	77	911.3884	3/8" Bit socket Torx, T50	1
18	917.4854	3/8" 12-edge socket with joint, 13 mm	1	48	911.3871	3/8" Bit socket Torx, T25	1	78	911.3888	3/8" Bit socket Torx, T55	1
19	917.4855	3/8" 12-edge socket with joint, 14 mm	1	49	911.3872	3/8" Bit socket Torx, T27	1	79	911.3889	3/8" Bit socket Torx, T60	1
20	917.4856	3/8" 12-edge socket with joint, 15 mm	1	50	911.3873	3/8" Bit socket Torx, T30	1	80	911.3920	3/8" Bit socket spline (XZN), M10	1
21	917.4857	3/8" 12-edge socket with joint, 16 mm	1	51	911.3874	3/8" Bit socket Torx, T40	1	81	917.3903	3/8" Bit socket spline (XZN), M12	1
22	917.4858	3/8" 12-edge socket with joint, 17 mm	1	52	911.3885	3/8" Bit socket Torx, T45	1	82	917.1404	1/4" Hexagonal socket, 4 mm	1
23	917.4859	3/8" 12-edge socket with joint, 18 mm	1	53	911.3917	3/8" Bit socket spline (XZN), M8	1	83	917.1405	1/4" Hexagonal socket, 5 mm	1
24	917.4861	3/8" 12-edge socket with joint, 19 mm	1	54	917.3901	3/8" Bit socket spline (XZN), M9	1	84	917.14055	1/4" Hexagonal socket, 5,5 mm	1
25	911.3918	3/8" Bit socket spline (XZN), M4	1	55	917.3806	3/8" Hexagonal socket, 6 mm	1	85	917.1406	1/4" Hexagonal socket, 6 mm	1
26	911.3915	3/8" Bit socket spline (XZN), M5	1	56	917.3807	3/8" Hexagonal socket, 7 mm	1	86	917.1407	1/4" Hexagonal socket, 7 mm	1
27	911.3916	3/8" Bit socket spline (XZN), M6	1	57	917.3808	3/8" Hexagonal socket, 8 mm	1	87	917.1408	1/4" Hexagonal socket, 8 mm	1
28	911.3981	3/8" 12 Point socket, 8 mm	1	58	917.3809	3/8" Hexagonal socket, 9 mm	1	88	917.1409	1/4" Hexagonal socket, 9 mm	1
29	911.3982	3/8" 12 Point socket, 9 mm	1	59	917.3810	3/8" Hexagonal socket, 10 mm	1	89	917.1410	1/4" Hexagonal socket, 10 mm	1
30	911.3983	3/8" 12 Point socket, 10 mm	1	60	917.3811	3/8" Hexagonal socket, 11 mm	1	90	917.1411	1/4" Hexagonal socket, 11 mm	1

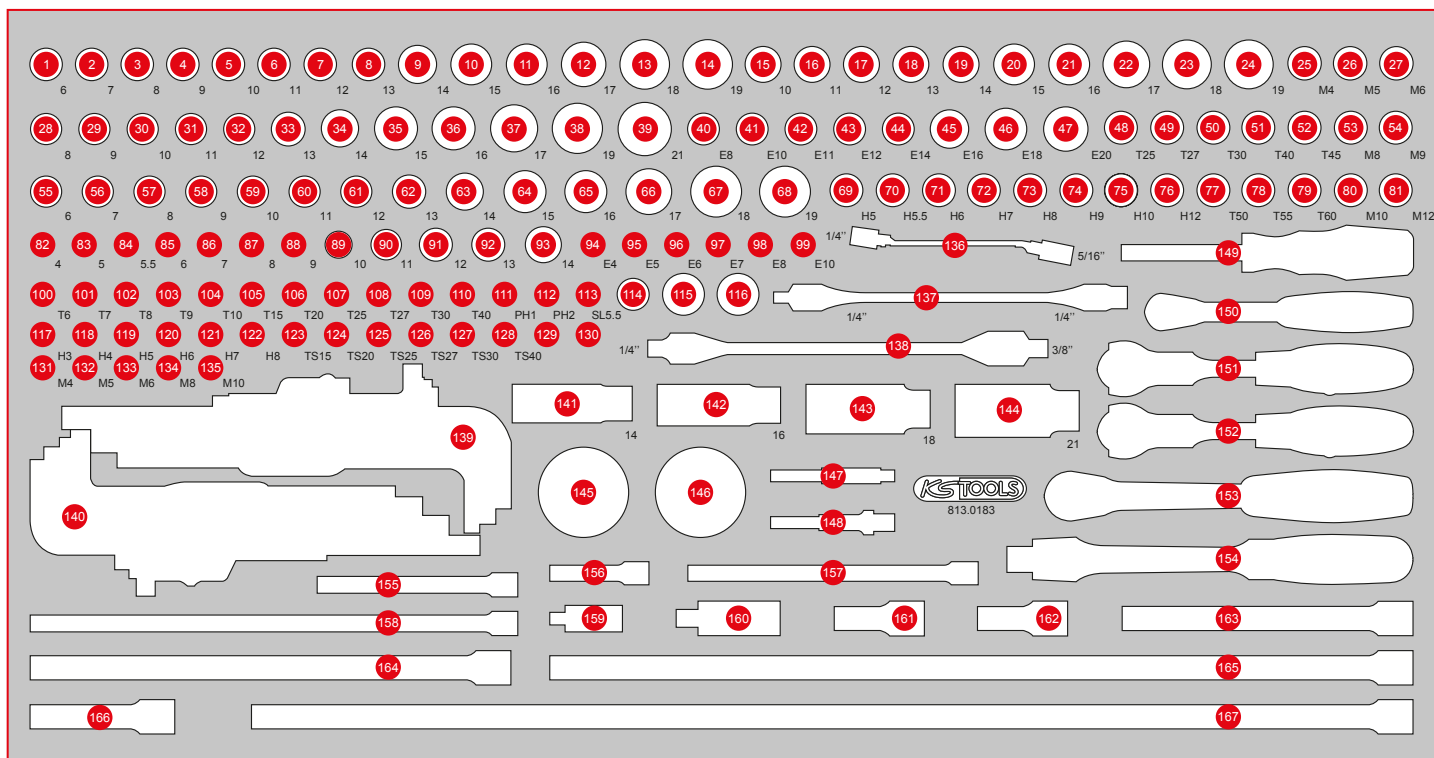

Pos.	Code	Description	pcs	Pos.	Code	Description	pcs	Pos.	Code	Description	pcs
91	917.1412	1/4" Hexagonal socket, 12 mm	1	121	911.1440	1/4" Bit socket hexagon, 7 mm	1	148	514.1107	Socket adaptor, 1/4"x3/8"	1
92	917.1413	1/4" Hexagonal socket, 13 mm	1	122	911.1441	1/4" Bit socket hexagon, 8 mm	1	149	911.1434	1/4" Square drive screwdriver, 150 mm	1
93	917.1414	1/4" Hexagonal socket, 14 mm	1	123	911.1702	1/4" Bit socket five star tamperproof, TS15	1	150	920.1490	1/4" SlimPOWER Reversible ratchet, 72 teeth	1
94	911.4313	1/4" Torx E Socket, E4	1	124	911.1703	1/4" Bit socket five star tamperproof, TS20	1	151	914.1405	1/4" MODIFIX mini T-handle swivel head ratchet, 72 teeth	1
95	911.4314	1/4" Torx E Socket, E5	1	125	911.1704	1/4" Bit socket five star tamperproof, TS25	1	152	914.3815	3/8" MODIFIX mini T-handle swivel head ratchet, 72 teeth, 0°+90°	1
96	911.4315	1/4" Torx E Socket, E6	1	126	911.1705	1/4" Bit socket five star tamperproof, TS27	1	153	920.3890	3/8" SlimPOWER Reversible ratchet, 72 teeth	1
97	911.4316	1/4" Torx E Socket, E7	1	127	911.1706	1/4" Bit socket five star tamperproof, TS30	1	154	917.3939	3/8" Flexi head drive handle	1
98	911.4317	1/4" Torx E Socket, E8	1	128	911.1707	1/4" Bit socket five star tamperproof, TS40	1	155	911.1424	1/4" Extension with hexagon drive, 100 mm	1
99	911.4332	1/4" Torx E Socket, E10	1	129	911.0101	1/4" socket with magnet	1	156	911.1423	1/4" Extension with hexagon drive, 50 mm	1
100	911.4407	1/4" Bit socket Torx, T6	1	130	911.1494	Adaptor, 1/4" Mx3/8" F	1	157	911.1451	1/4" Extension with hexagon drive, 150 mm	1
101	911.4362	1/4" Bit socket Torx, T7	1	131	911.2341	1/4" Bit spline XZN, 25 mm, M4	1	158	911.1543	1/4" Wobble extension with hexagon drive, 250 mm	1
102	911.1448	1/4" Bit socket Torx, T8	1	132	911.2344	1/4" Bit spline XZN, 25 mm, M5	1	159	911.1450	1/4" Universal joint	1
103	911.1478	1/4" Bit socket Torx, T9	1	133	911.2347	1/4" Bit spline XZN, 25 mm, M6	1	160	911.3850	3/8" Universal joint	1
104	911.1442	1/4" Bit socket Torx, T10	1	134	911.2350	1/4" Bit spline XZN, 25 mm, M8	1	161	911.3852	3/8" Extension with knurling, 45 mm	1
105	911.1443	1/4" Bit socket Torx, T15	1	135	911.2353	1/4" Bit spline XZN, 25 mm, M10	1	162	911.3910	Wobble extension, 3/8", 45 mm	1
106	911.1444	1/4" Bit socket Torx, T20	1	136	503.4679	GEARplus mini reversible ratcheting spanner, 1/4"x5/16"	1	163	911.3912	Wobble extension, 3/8", 150 mm	1
107	911.1445	1/4" Bit socket Torx, T25	1	137	517.0314	Double-joint spanner 1/4" Bits and sockets	1	164	911.3914	Wobble extension, 3/8", 250 mm	1
108	911.1449	1/4" Bit socket Torx, T27	1	138	517.0338	Double-joint-spanner for 1/4" and 3/8" sockets	1	165	911.0045	Wobble extension, 3/8", 450 mm	1
109	911.1446	1/4" Bit socket Torx, T30	1	139	151.4530	Ball ended Torx key wrench set, extra long and bent 108°, 9 pcs	9	166	911.3911	Wobble extension, 3/8", 75 mm	1
110	911.1447	1/4" Bit socket Torx, T40	1	140	151.4420	Ball ended hexagon key wrench set, extra long, 9 pcs	9	167	911.4892	3/8" Extensions 600 mm	1
111	911.1415	1/4" Bit socket, PH1	1	141	911.3990	3/8" Special spark plug socket, thin-walled 14 mm	1				
112	911.1416	1/4" Bit socket, PH2	1	142	911.3804	3/8" Spark plug socket, 16 mm	1				
113	911.1419	1/4" Bit socket slot, 5,5 mm	1	143	911.3823	3/8" Spark plug socket, 18 mm	1				
114	911.3897	3/8" Reducing adaptor, 3/8" F x 1/4" M	1	144	911.3805	3/8" Spark plug socket, 21 mm	1				
115	911.1233	Reducing adaptor, 1/2" F x 3/8" M	1	145	914.1410	Mini hand reversible ratchet, 1/4", 72 teethh	1				
116	911.4351	1/2" Bit adaptor socket, 1/2" x 5/16", 38mm	1	146	914.3810	Mini hand reversible ratchet, 3/8", 72 teethh	1				
117	911.1436	1/4" Bit socket hexagon, 3 mm	1	147	514.1106	Socket adaptor, 1/4"x1/4"	1				
118	911.1437	1/4" Bit socket hexagon, 4 mm	1								
119	911.1438	1/4" Bit socket hexagon, 5 mm	1								
120	911.1439	1/4" Bit socket hexagon, 6 mm	1								

P 10

P 15

P 20

P 25

P 30

P 35

P 40

P 45

L M

S XL

Individual parts

Accessories

813.0213

L 1/4" + 3/8" Socket spanner set

629, — ^{EUR}



IPCS
213

755 x 398 **P25**

Pos.	Code	Description	pcs	Pos.	Code	Description	pcs	Pos.	Code	Description	pcs
1	911.3915	3/8" Bit socket spline (XZN), M5	1	39	917.3923	3/8" RIBE® Bit socket, M6	1	77	911.1419	1/4" Bit socket slot, 5,5 mm	1
2	911.3916	3/8" Bit socket spline (XZN), M6	1	40	917.3924	3/8" RIBE® Bit socket, M7	1	78	917.1421	1/4" Bit socket slot, 6,5 mm	1
3	911.3917	3/8" Bit socket spline (XZN), M8	1	41	917.3925	3/8" RIBE® Bit socket, M8	1	79	911.1701	1/4" Bit socket five star tamperproof, TS10	1
4	917.3901	3/8" Bit socket spline (XZN), M9	1	42	917.3926	3/8" RIBE® Bit socket, M9	1	80	911.1702	1/4" Bit socket five star tamperproof, TS15	1
5	911.3920	3/8" Bit socket spline (XZN), M10	1	43	917.3927	3/8" RIBE® Bit socket, M10	1	81	911.1703	1/4" Bit socket five star tamperproof, TS20	1
6	917.3903	3/8" Bit socket spline (XZN), M12	1	44	917.3928	3/8" RIBE® Bit socket, M12	1	82	911.1704	1/4" Bit socket five star tamperproof, TS25	1
7	911.3934	3/8" Bit socket Torx, T8	1	45	911.3863	3/8" Bit socket hexagon, 3 mm	1	83	911.1705	1/4" Bit socket five star tamperproof, TS27	1
8	911.3887	3/8" Bit socket Torx, T10	1	46	911.3864	3/8" Bit socket hexagon, 4 mm	1	84	911.1706	1/4" Bit socket five star tamperproof, TS30	1
9	911.3869	3/8" Bit socket Torx, T15	1	47	911.3865	3/8" Bit socket hexagon, 5 mm	1	85	911.1707	1/4" Bit socket five star tamperproof, TS40	1
10	911.3870	3/8" Bit socket Torx, T20	1	48	911.38655	3/8" Bit socket hexagon, 5,5 mm	1	86	911.1461	1/4" Bit socket Torx tamperproof, TB8	1
11	911.3871	3/8" Bit socket Torx, T25	1	49	911.3866	3/8" Bit socket hexagon, 6 mm	1	87	911.1462	1/4" Bit socket Torx tamperproof, TB10	1
12	911.3872	3/8" Bit socket Torx, T27	1	50	911.3867	3/8" Bit socket hexagon, 7 mm	1	88	911.1463	1/4" Bit socket Torx tamperproof, TB15	1
13	911.3873	3/8" Bit socket Torx, T30	1	51	911.3868	3/8" Bit socket hexagon, 8 mm	1	89	911.1464	1/4" Bit socket Torx tamperproof, TB20	1
14	911.3874	3/8" Bit socket Torx, T40	1	52	917.3969	3/8" Bit socket hexagon, 9 mm	1	90	911.1465	1/4" Bit socket Torx tamperproof, TB25	1
15	911.3885	3/8" Bit socket Torx, T45	1	53	917.3857	3/8" Bit socket hexagon, 10 mm	1	91	911.1466	1/4" Bit socket Torx tamperproof, TB27	1
16	911.3884	3/8" Bit socket Torx, T50	1	54	911.3862	3/8" Bit socket hexagon, 12 mm	1	92	911.1467	1/4" Bit socket Torx tamperproof, TB30	1
17	911.3888	3/8" Bit socket Torx, T55	1	55	911.3878	3/8" Bit socket slot, 5,5 mm	1	93	911.1468	1/4" Bit socket Torx tamperproof, TB40	1
18	911.3889	3/8" Bit socket Torx, T60	1	56	911.3943	3/8" Bit socket slot 6 mm	1	94	911.1483	1/4" Bit socket, PZ0	1
19	911.3875	3/8" Bit socket, PH1	1	57	911.3944	3/8" Bit socket slot 7 mm	1	95	911.1401	1/4" Bit socket, PZ1	1
20	911.3876	3/8" Bit socket, PH2	1	58	911.1436	1/4" Bit socket hexagon, 3 mm	1	96	911.1402	1/4" Bit socket, PZ2	1
21	911.3877	3/8" Bit socket, PH3	1	59	911.1437	1/4" Bit socket hexagon, 4 mm	1	97	917.3806	3/8" Hexagonal socket, 6 mm	1
22	911.3881	3/8" Bit socket, PZ1	1	60	911.1438	1/4" Bit socket hexagon, 5 mm	1	98	917.3807	3/8" Hexagonal socket, 7 mm	1
23	911.3882	3/8" Bit socket, PZ2	1	61	911.1439	1/4" Bit socket hexagon, 6 mm	1	99	917.3808	3/8" Hexagonal socket, 8 mm	1
24	911.3883	3/8" Bit socket, PZ3	1	62	911.1440	1/4" Bit socket hexagon, 7 mm	1	100	917.3809	3/8" Hexagonal socket, 9 mm	1
25	917.3929	3/8" Bit socket Torx tamperproof, TB8	1	63	911.1441	1/4" Bit socket hexagon, 8 mm	1	101	917.3810	3/8" Hexagonal socket, 10 mm	1
26	911.3960	3/8" Bit socket Torx tamperproof, TB10	1	64	917.1452	1/4" Bit socket hexagon, 10 mm	1	102	917.3811	3/8" Hexagonal socket, 11 mm	1
27	911.3961	3/8" Bit socket Torx tamperproof, TB15	1	65	911.1448	1/4" Bit socket Torx, T8	1	103	917.3812	3/8" Hexagonal socket, 12 mm	1
28	911.3962	3/8" Bit socket Torx tamperproof, TB20	1	66	911.1442	1/4" Bit socket Torx, T10	1	104	917.3813	3/8" Hexagonal socket, 13 mm	1
29	911.3963	3/8" Bit socket Torx tamperproof, TB25	1	67	911.1443	1/4" Bit socket Torx, T15	1	105	917.3814	3/8" Hexagonal socket, 14 mm	1
30	911.3964	3/8" Bit socket Torx tamperproof, TB27	1	68	911.1444	1/4" Bit socket Torx, T20	1	106	917.3815	3/8" Hexagonal socket, 15 mm	1
31	911.3965	3/8" Bit socket Torx tamperproof, TB30	1	69	911.1445	1/4" Bit socket Torx, T25	1	107	917.3816	3/8" Hexagonal socket, 16 mm	1
32	911.3966	3/8" Bit socket Torx tamperproof, TB40	1	70	911.1449	1/4" Bit socket Torx, T27	1	108	917.3817	3/8" Hexagonal socket, 17 mm	1
33	911.3967	3/8" Bit socket Torx tamperproof, TB45	1	71	911.1446	1/4" Bit socket Torx, T30	1	109	917.3818	3/8" Hexagonal socket, 18 mm	1
34	911.3968	3/8" Bit socket Torx tamperproof, TB50	1	72	911.1447	1/4" Bit socket Torx, T40	1	110	917.3819	3/8" Hexagonal socket, 19 mm	1
35	911.3969	3/8" Bit socket Torx tamperproof, TB55	1	73	911.1482	1/4" Bit socket, PH0	1	111	917.3820	3/8" Hexagonal socket, 20 mm	1
36	911.3970	3/8" Bit socket Torx tamperproof, TB60	1	74	911.1415	1/4" Bit socket, PH1	1	112	917.3821	3/8" Hexagonal socket, 21 mm	1
37	917.3921	3/8" RIBE® Bit socket, M4	1	75	911.1416	1/4" Bit socket, PH2	1	113	917.3822	3/8" Hexagonal socket, 22 mm	1
38	917.3922	3/8" RIBE® Bit socket, M5	1	76	911.1418	1/4" Bit socket slot, 4 mm	1	114	911.0101	1/4" socket with magnet	1

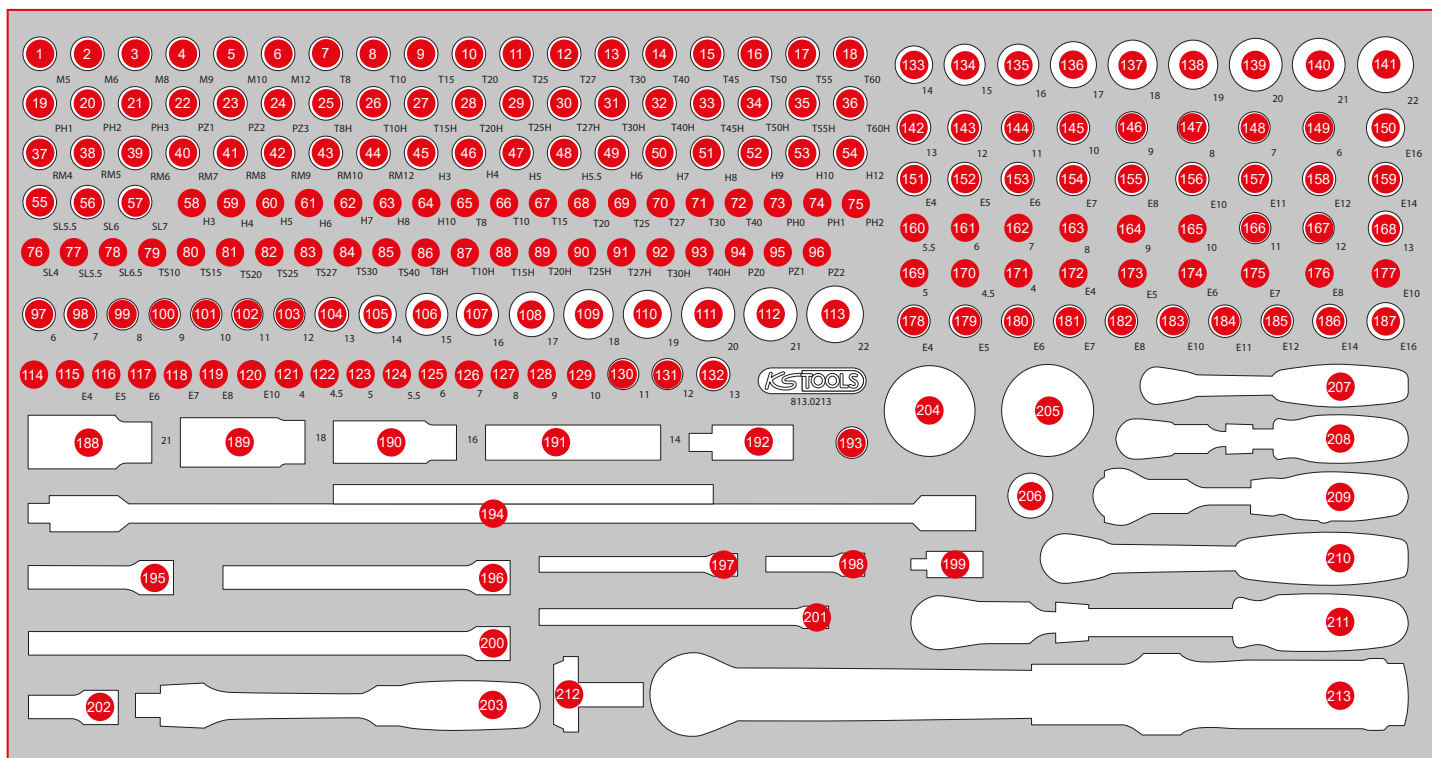

Pos.	Code	Description	pcs	Pos.	Code	Description	pcs	Pos.	Code	Description	pcs
115	911.4313	1/4" Torx E Socket, E4	1	153	911.4386	3/8" Torx E socket, E6, long	1	191	911.3999	3/8" Special spark plug socket for BMW with flexible joint, 14mm	1
116	911.4314	1/4" Torx E Socket, E5	1	154	911.4387	3/8" Torx E socket, E7, long	1	192	911.3850	3/8" Universal joint	1
117	911.4315	1/4" Torx E Socket, E6	1	155	911.4388	3/8" Torx E socket, E8, long	1	193	911.3897	3/8" Reducing adaptor, 3/8"F x 1/4"M	1
118	911.4316	1/4" Torx E Socket, E7	1	156	911.4390	3/8" Torx E socket, E10, long	1	194	517.1126	T-Handle universal wrench for sockets, extra long, 3/8"	1
119	911.4317	1/4" Torx E Socket, E8	1	157	911.4391	3/8" Torx E socket, E11, long	1	195	911.3801	3/8" Extension with knurling, 75 mm	1
120	911.4332	1/4" Torx E Socket, E10	1	158	911.4392	3/8" Torx E socket, E12, long	1	196	911.3802	3/8" Extension with knurling, 150 mm	1
121	917.1404	1/4" Hexagonal socket, 4 mm	1	159	911.4394	3/8" Torx E socket, E14, long	1	197	911.1424	1/4" Extension with hexagon drive, 100 mm	1
122	917.14045	1/4" Hexagonal socket, 4,5 mm	1	160	917.1528	1/4" Hexagonal socket, deep, 5,5 mm	1	198	911.1423	1/4" Extension with hexagon drive, 50 mm	1
123	917.1405	1/4" Hexagonal socket, 5 mm	1	161	917.1426	1/4" Hexagonal socket, deep, 6 mm	1	199	911.1450	1/4" Universal joint	1
124	917.14055	1/4" Hexagonal socket, 5,5 mm	1	162	917.1427	1/4" Hexagonal socket, deep, 7 mm	1	200	911.3803	3/8" Extension with knurling, 250 mm	1
125	917.1406	1/4" Hexagonal socket, 6 mm	1	163	917.1428	1/4" Hexagonal socket, deep, 8 mm	1	201	911.1451	1/4" Extension with hexagon drive, 150 mm	1
126	917.1407	1/4" Hexagonal socket, 7 mm	1	164	917.1429	1/4" Hexagonal socket, deep, 9 mm	1	202	911.3852	3/8" Extension with knurling, 45 mm	1
127	917.1408	1/4" Hexagonal socket, 8 mm	1	165	917.1430	1/4" Hexagonal socket, deep, 10 mm	1	203	917.3939	3/8" Flexi head drive handle	1
128	917.1409	1/4" Hexagonal socket, 9 mm	1	166	917.1431	1/4" Hexagonal socket, deep, 11 mm	1	204	914.1410	Mini hand reversible ratchet, 1/4", 72 teeth	1
129	917.1410	1/4" Hexagonal socket, 10 mm	1	167	917.1432	1/4" Hexagonal socket, deep, 12 mm	1	205	914.3810	Mini hand reversible ratchet, 3/8", 72 teeth	1
130	917.1411	1/4" Hexagonal socket, 11 mm	1	168	917.1433	1/4" Hexagonal socket, deep, 13 mm	1	206	911.3826	3/8" Sliding / reducing adaptor, 1/2"F x 3/8"M	1
131	917.1412	1/4" Hexagonal socket, 12 mm	1	169	917.1527	1/4" Hexagonal socket, deep, 5 mm	1	207	920.1490	1/4" SlimPOWER Reversible ratchet, 72 teeth	1
132	917.1413	1/4" Hexagonal socket, 13 mm	1	170	917.1526	1/4" Hexagonal socket, deep, 4,5 mm	1	208	914.1420	1/4" SlimPOWER telescopic-joint reversible ratchet, 72 teeth	1
133	917.3834	3/8" Hexagonal socket, deep, 14 mm	1	171	917.1525	1/4" Hexagonal socket, deep, 4 mm	1	209	914.1405	1/4" MODIFIX mini T-handle swivel head ratchet, 72 teeth	1
134	917.3835	3/8" Hexagonal socket, deep, 15 mm	1	172	917.2401	1/4" Torx E Socket, deep, E4	1	210	920.3890	3/8" SlimPOWER Reversible ratchet, 72 teeth	1
135	917.3836	3/8" Hexagonal socket, deep, 16 mm	1	173	917.2402	1/4" Torx E Socket, deep, E5	1	211	914.3820	3/8" SlimPOWER Telescopic reversible ratchet, 72 teeth	1
136	917.3837	3/8" Hexagonal socket, deep, 17 mm	1	174	917.2403	1/4" Torx E Socket, deep, E6	1	212	516.1428	Rotary square box wrench, 1/2"x3/8"	1
137	917.3838	3/8" Hexagonal socket, deep, 18 mm	1	175	917.2404	1/4" Torx E Socket, deep, E7	1	213	516.1432	1/2" ERGOTORQUE® precision torque wrench with rotary mushroom ratchet head, 20-100Nm	1
138	917.3839	3/8" Hexagonal socket, deep, 19 mm	1	176	917.2405	1/4" Torx E Socket, deep, E8	1				
139	917.3840	3/8" Hexagonal socket, deep, 20 mm	1	177	917.2406	1/4" Torx E Socket, deep, E10	1				
140	917.3841	3/8" Hexagonal socket, deep, 21 mm	1	178	911.4338	3/8" Torx E Socket, E4	1				
141	917.3842	3/8" Hexagonal socket, deep, 22 mm	1	179	911.4339	3/8" Torx E Socket, E5	1				
142	917.3833	3/8" Hexagonal socket, deep, 13 mm	1	180	911.4340	3/8" Torx E Socket, E6	1				
143	917.3832	3/8" Hexagonal socket, deep, 12 mm	1	181	911.4341	3/8" Torx E Socket, E7	1				
144	917.3831	3/8" Hexagonal socket, deep, 11 mm	1	182	911.4342	3/8" Torx E Socket, E8	1				
145	917.3830	3/8" Hexagonal socket, deep, 10 mm	1	183	911.4318	3/8" Torx E Socket, E10	1				
146	917.3829	3/8" Hexagonal socket, deep, 9 mm	1	184	911.4319	3/8" Torx E Socket, E11	1				
147	917.3828	3/8" Hexagonal socket, deep, 8 mm	1	185	911.4320	3/8" Torx E Socket, E12	1				
148	917.4807	3/8" Hexagonal socket, deep, 7 mm	1	186	911.4321	3/8" Torx E Socket, E14	1				
149	917.4806	3/8" Hexagonal socket, deep, 6 mm	1	187	911.4343	3/8" Torx E Socket, E16	1				
150	911.4396	3/8" Torx E socket, E16, long	1	188	911.3805	3/8" Spark plug socket, 21 mm	1				
151	911.4384	3/8" Torx E socket, E4, long	1	189	911.3823	3/8" Spark plug socket, 18 mm	1				
152	911.4385	3/8" Torx E socket, E5, long	1	190	911.3804	3/8" Spark plug socket, 16 mm	1				

P 10
P 15
P 20
P 25
P 30
P 35
P 40
P 45
Individual parts S XL L M
Accessories

813.0165

L 3/8" Socket spanner set

579,^{EUR}-



165

755 x 398 P25

Pos.	Code	Description	pcs	Pos.	Code	Description	pcs	Pos.	Code	Description	pcs
1	516.1432	1/2" ERGOTORQUE® precision torque wrench with rotary mushroom ratchet head, 20-100Nm	1	27	911.1564	3/8" Bit socket hexagon, long, 7 mm	1	56	911.4390	3/8" Torx E socket, E10, long	1
2	516.1428	Rotary square box wrench, 1/2"x3/8"	1	28	911.1565	3/8" Bit socket hexagon, long, 8 mm	1	57	911.4391	3/8" Torx E socket, E11, long	1
3	920.3890	3/8" SlimPOWER Reversible ratchet, 72 teeth	1	29	917.1594	3/8" Bit socket hexagon, long, 9 mm	1	58	911.4392	3/8" Torx E socket, E12, long	1
4	914.3815	3/8" MODIFIX mini T-handle swivel head ratchet, 72 teeth, 0°+90°	1	30	911.1566	3/8" Bit socket hexagon, long, 10 mm	1	59	911.4394	3/8" Torx E socket, E14, long	1
5	917.3939	3/8" Flexi head drive handle	1	31	917.1577	3/8" Bit socket Torx, long, T10	1	60	911.4396	3/8" Torx E socket, E16, long	1
6	911.3803	3/8" Extension with knurling, 250 mm	1	32	917.1579	3/8" Bit socket Torx, long, T15	1	61	911.4398	3/8" Torx E socket, E18, long	1
7	517.1126	T-Handle universal wrench for sockets, extra long, 3/8"	1	33	911.1551	3/8" Bit socket Torx, long, T20	1	62	911.4399	3/8" Torx E socket, E20, long	1
8	911.3852	3/8" Extension with knurling, 45 mm	1	34	911.1552	3/8" Bit socket Torx, long, T25	1	63	917.4806	3/8" Hexagonal socket, deep, 6 mm	1
9	911.3801	3/8" Extension with knurling, 75 mm	1	35	911.1553	3/8" Bit socket Torx, long, T27	1	64	917.4807	3/8" Hexagonal socket, deep, 7 mm	1
10	911.0030	Wobble extension, 3/8", 300 mm	1	36	911.1554	3/8" Bit socket Torx, long, T30	1	65	917.3828	3/8" Hexagonal socket, deep, 8 mm	1
11	911.0045	Wobble extension, 3/8", 450 mm	1	37	911.1555	3/8" Bit socket Torx, long, T40	1	66	917.3829	3/8" Hexagonal socket, deep, 9 mm	1
12	911.3802	3/8" Extension with knurling, 150 mm	1	38	911.1556	3/8" Bit socket Torx, long, T45	1	67	917.3830	3/8" Hexagonal socket, deep, 10 mm	1
13	911.3931	3/8" T-Handle-Spinner	1	39	911.1557	3/8" Bit socket Torx, long, T50	1	68	917.3831	3/8" Hexagonal socket, deep, 11 mm	1
14	911.3912	Wobble extension, 3/8", 150 mm	1	40	917.3904	XZN spline bit socket, 3/8", M5, long	1	69	917.3832	3/8" Hexagonal socket, deep, 12 mm	1
15	911.3913	Wobble extension, 3/8", 200 mm	1	41	917.3905	XZN spline bit socket, 3/8", M6, long	1	70	917.3833	3/8" Hexagonal socket, deep, 13 mm	1
16	911.3910	Wobble extension, 3/8", 45 mm	1	42	917.3906	XZN spline bit socket, 3/8", M8, long	1	71	917.3834	3/8" Hexagonal socket, deep, 14 mm	1
17	911.3826	3/8" Sliding / reducing adaptor, 1/2" F x 3/8" M	1	43	917.3907	XZN spline bit socket, 3/8", M9, long	1	72	917.3835	3/8" Hexagonal socket, deep, 15 mm	1
18	911.3850	3/8" Universal joint	1	44	917.3908	XZN spline bit socket, 3/8", M10, long	1	73	917.3836	3/8" Hexagonal socket, deep, 16 mm	1
19	911.3990	3/8" Special spark plug socket, thin-walled, 14 mm	1	45	917.3909	XZN spline bit socket, 3/8", M12, long	1	74	917.3837	3/8" Hexagonal socket, deep, 17 mm	1
20	911.3804	3/8" Spark plug socket, 16 mm	1	46	917.3930	3/8" RIBE® Bit socket, long, M5	1	75	917.3838	3/8" Hexagonal socket, deep, 18 mm	1
21	911.3823	3/8" Spark plug socket, 18 mm	1	47	917.3931	3/8" RIBE® Bit socket, long, M6	1	76	917.3839	3/8" Hexagonal socket, deep, 19 mm	1
22	911.3805	3/8" Spark plug socket, 21 mm	1	48	917.3932	3/8" RIBE® Bit socket, long, M7	1	77	917.3840	3/8" Hexagonal socket, deep, 20 mm	1
23	911.1561	3/8" Bit socket hexagon, long, 4 mm	1	49	917.3933	3/8" RIBE® Bit socket, long, M8	1	78	917.3841	3/8" Hexagonal socket, deep, 21 mm	1
24	911.1562	3/8" Bit socket hexagon, long, 5 mm	1	50	917.3934	3/8" RIBE® Bit socket, long, M9	1	79	917.3842	3/8" Hexagonal socket, deep, 22 mm	1
25	911.15625	3/8" Bit socket hexagon, long, 5,5 mm	1	51	917.3935	3/8" RIBE® Bit socket, long, M10	1	80	911.4340	3/8" Torx E Socket, E6	1
26	911.1563	3/8" Bit socket hexagon, long, 6 mm	1	52	917.3936	3/8" RIBE® Bit socket, long, M12	1	81	911.4341	3/8" Torx E Socket, E7	1
				53	911.4386	3/8" Torx E socket, E6, long	1	82	911.4342	3/8" Torx E Socket, E8	1
				54	911.4387	3/8" Torx E socket, E7, long	1	83	911.4318	3/8" Torx E Socket, E10	1
				55	911.4388	3/8" Torx E socket, E8, long	1	84	911.4319	3/8" Torx E Socket, E11	1

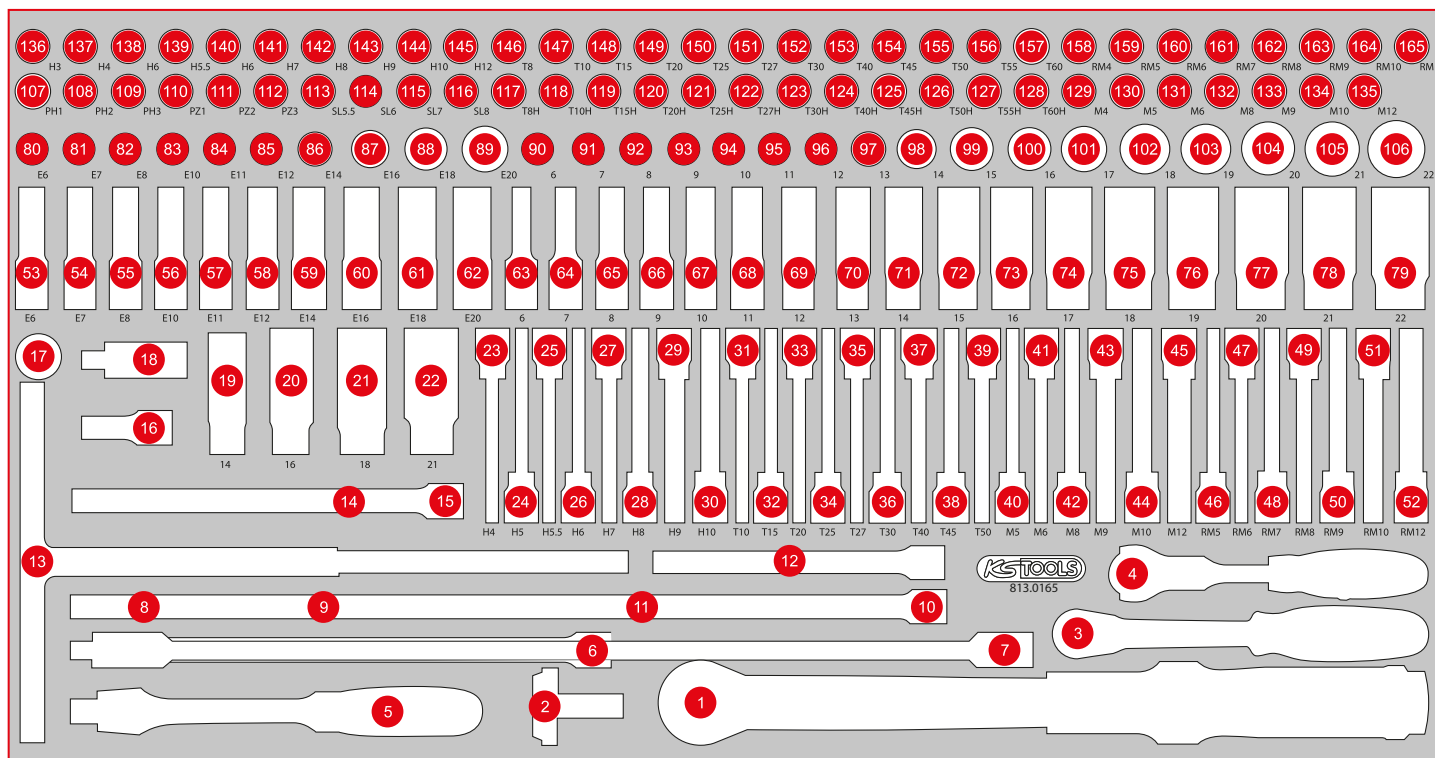

Pos.	Code	Description	pcs	Pos.	Code	Description	pcs	Pos.	Code	Description	pcs
85	911.4320	3/8" Torx E Socket, E12	1	115	911.3944	3/8" Bit socket slot 7 mm	1	144	917.3857	3/8" Bit socket hexagon, 10 mm	1
86	911.4321	3/8" Torx E Socket, E14	1	116	911.3880	3/8" Bit socket slot, 8 mm	1	145	911.3862	3/8" Bit socket hexagon, 12 mm	1
87	911.4343	3/8" Torx E Socket, E16	1	117	917.3929	3/8" Bit socket Torx tamperproof, TB8	1	146	911.3934	3/8" Bit socket Torx, T8	1
88	911.4344	3/8" Torx E Socket, E18	1	118	911.3960	3/8" Bit socket Torx tamperproof, TB10	1	147	911.3887	3/8" Bit socket Torx, T10	1
89	911.4345	3/8" Torx E Socket, E20	1	119	911.3961	3/8" Bit socket Torx tamperproof, TB15	1	148	911.3869	3/8" Bit socket Torx, T15	1
90	917.3806	3/8" Hexagonal socket, 6 mm	1	120	911.3962	3/8" Bit socket Torx tamperproof, TB20	1	149	911.3870	3/8" Bit socket Torx, T20	1
91	917.3807	3/8" Hexagonal socket, 7 mm	1	121	911.3963	3/8" Bit socket Torx tamperproof, TB25	1	150	911.3871	3/8" Bit socket Torx, T25	1
92	917.3808	3/8" Hexagonal socket, 8 mm	1	122	911.3964	3/8" Bit socket Torx tamperproof, TB27	1	151	911.3872	3/8" Bit socket Torx, T27	1
93	917.3809	3/8" Hexagonal socket, 9 mm	1	123	911.3965	3/8" Bit socket Torx tamperproof, TB30	1	152	911.3873	3/8" Bit socket Torx, T30	1
94	917.3810	3/8" Hexagonal socket, 10 mm	1	124	911.3966	3/8" Bit socket Torx tamperproof, TB40	1	153	911.3874	3/8" Bit socket Torx, T40	1
95	917.3811	3/8" Hexagonal socket, 11 mm	1	125	911.3967	3/8" Bit socket Torx tamperproof, TB45	1	154	911.3885	3/8" Bit socket Torx, T45	1
96	917.3812	3/8" Hexagonal socket, 12 mm	1	126	911.3968	3/8" Bit socket Torx tamperproof, TB50	1	155	911.3884	3/8" Bit socket Torx, T50	1
97	917.3813	3/8" Hexagonal socket, 13 mm	1	127	911.3969	3/8" Bit socket Torx tamperproof, TB55	1	156	911.3888	3/8" Bit socket Torx, T55	1
98	917.3814	3/8" Hexagonal socket, 14 mm	1	128	911.3970	3/8" Bit socket Torx tamperproof, TB60	1	157	911.3889	3/8" Bit socket Torx, T60	1
99	917.3815	3/8" Hexagonal socket, 15 mm	1	129	911.3918	3/8" Bit socket spline (XZN), M4	1	158	917.3921	3/8" RIBE® Bit socket, M4	1
100	917.3816	3/8" Hexagonal socket, 16 mm	1	130	911.3915	3/8" Bit socket spline (XZN), M5	1	159	917.3922	3/8" RIBE® Bit socket, M5	1
101	917.3817	3/8" Hexagonal socket, 17 mm	1	131	911.3916	3/8" Bit socket spline (XZN), M6	1	160	917.3923	3/8" RIBE® Bit socket, M6	1
102	917.3818	3/8" Hexagonal socket, 18 mm	1	132	911.3917	3/8" Bit socket spline (XZN), M8	1	161	917.3924	3/8" RIBE® Bit socket, M7	1
103	917.3819	3/8" Hexagonal socket, 19 mm	1	133	917.3901	3/8" Bit socket spline (XZN), M9	1	162	917.3925	3/8" RIBE® Bit socket, M8	1
104	917.3820	3/8" Hexagonal socket, 20 mm	1	134	911.3920	3/8" Bit socket spline (XZN), M10	1	163	917.3926	3/8" RIBE® Bit socket, M9	1
105	917.3821	3/8" Hexagonal socket, 21 mm	1	135	917.3903	3/8" Bit socket spline (XZN), M12	1	164	917.3927	3/8" RIBE® Bit socket, M10	1
106	917.3822	3/8" Hexagonal socket, 22 mm	1	136	911.3863	3/8" Bit socket hexagon, 3 mm	1	165	917.3928	3/8" RIBE® Bit socket, M12	1
107	911.3875	3/8" Bit socket, PH1	1	137	911.3864	3/8" Bit socket hexagon, 4 mm	1				
108	911.3876	3/8" Bit socket, PH2	1	138	911.3865	3/8" Bit socket hexagon, 5 mm	1				
109	911.3877	3/8" Bit socket, PH3	1	139	911.38655	3/8" Bit socket hexagon, 5,5 mm	1				
110	911.3881	3/8" Bit socket, PZ1	1	140	911.3866	3/8" Bit socket hexagon, 6 mm	1				
111	911.3882	3/8" Bit socket, PZ2	1	141	911.3867	3/8" Bit socket hexagon, 7 mm	1				
112	911.3883	3/8" Bit socket, PZ3	1	142	911.3868	3/8" Bit socket hexagon, 8 mm	1				
113	911.3878	3/8" Bit socket slot, 5,5 mm	1	143	917.3969	3/8" Bit socket hexagon, 9 mm	1				
114	911.3943	3/8" Bit socket slot 6 mm	1								

P 10
P 15
P 20
P 25
P 30
P 35
P 40
P 45
Individual parts S XL L M
Accessories

813.0085

L 1/2" Socket spanner set

419,^{EUR}-



85

755 x 398 P25

Pos.	Code	Description	pcs	Pos.	Code	Description	pcs	Pos.	Code	Description	pcs
1	911.1587	1/2" 12 Point socket, 32 mm	1	17	917.1221	1/2" Hexagonal socket, 21 mm	1	33	911.1313	1/2" Bit socket spline (XZN), M9, 55 mm	1
2	911.1586	1/2" 12 Point socket, 30 mm	1	18	917.1219	1/2" Hexagonal socket, 19 mm	1	34	911.1343	1/2" Bit socket spline (XZN), M10, 55 mm	1
3	917.1366	1/2" 12 Point socket, 29 mm	1	19	917.1218	1/2" Hexagonal socket, 18 mm	1	35	911.1344	1/2" Bit socket spline (XZN), M12, 55 mm	1
4	911.1585	1/2" 12 Point socket, 27 mm	1	20	917.1217	1/2" Hexagonal socket, 17 mm	1	36	911.1345	1/2" Bit socket spline (XZN), M14, 55 mm	1
5	911.1584	1/2" 12 Point socket, 24 mm	1	21	150.1707	Special drive shaft impact socket, 1/2", 36 mm	1	37	911.1346	1/2" Bit socket spline (XZN), M16, 55 mm	1
6	911.1582	1/2" 12 Point socket, 22 mm	1	22	150.1704	Special drive shaft impact socket, 1/2", 34 mm	1	38	911.5306	1/2" Bit socket spline (XZN), M17, 55 mm	1
7	911.1581	1/2" 12 Point socket, 21 mm	1	23	917.1275	1/2" 12 Point socket, deep, 32 mm	1	39	911.1348	1/2" Bit socket spline (XZN) tamperproof, M16, 55 mm	1
8	911.1579	1/2" 12 Point socket, 19 mm	1	24	917.1274	1/2" 12 Point socket, deep, 30 mm	1	40	911.1365	1/2" Bit socket Torx, T40	1
9	911.1578	1/2" 12 Point socket, 18 mm	1	25	917.5329	1/2" 12 Point socket, deep, 29 mm	1	41	911.1366	1/2" Bit socket Torx, T45	1
10	911.1577	1/2" 12 Point socket, 17 mm	1	26	917.1273	1/2" 12 Point socket, deep, 27 mm	1	42	911.1367	1/2" Bit socket Torx, T50	1
11	917.1232	1/2" Hexagonal socket, 32 mm	1	27	917.1272	1/2" 12 Point socket, deep, 24 mm	1	43	911.1368	1/2" Bit socket Torx, T55	1
12	917.1230	1/2" Hexagonal socket, 30 mm	1	28	917.1271	1/2" 12 Point socket, deep, 22 mm	1	44	911.1369	1/2" Bit socket Torx, T60	1
13	917.1345	1/2" Hexagonal socket, 29 mm	1	29	917.1270	1/2" 12 Point socket, deep, 21 mm	1	45	911.1370	1/2" Bit socket Torx, T70	1
14	917.1227	1/2" Hexagonal socket, 27 mm	1	30	917.1269	1/2" 12 Point socket, deep, 19 mm	1	46	911.1308	1/2" Bit socket hexagon, short, 8 mm	1
15	917.1224	1/2" Hexagonal socket, 24 mm	1	31	917.1268	1/2" 12 Point socket, deep, 18 mm	1	47	911.1310	1/2" Bit socket hexagon, short, 10 mm	1
16	917.1222	1/2" Hexagonal socket, 22 mm	1	32	917.1267	1/2" 12 Point socket, deep, 17 mm	1				

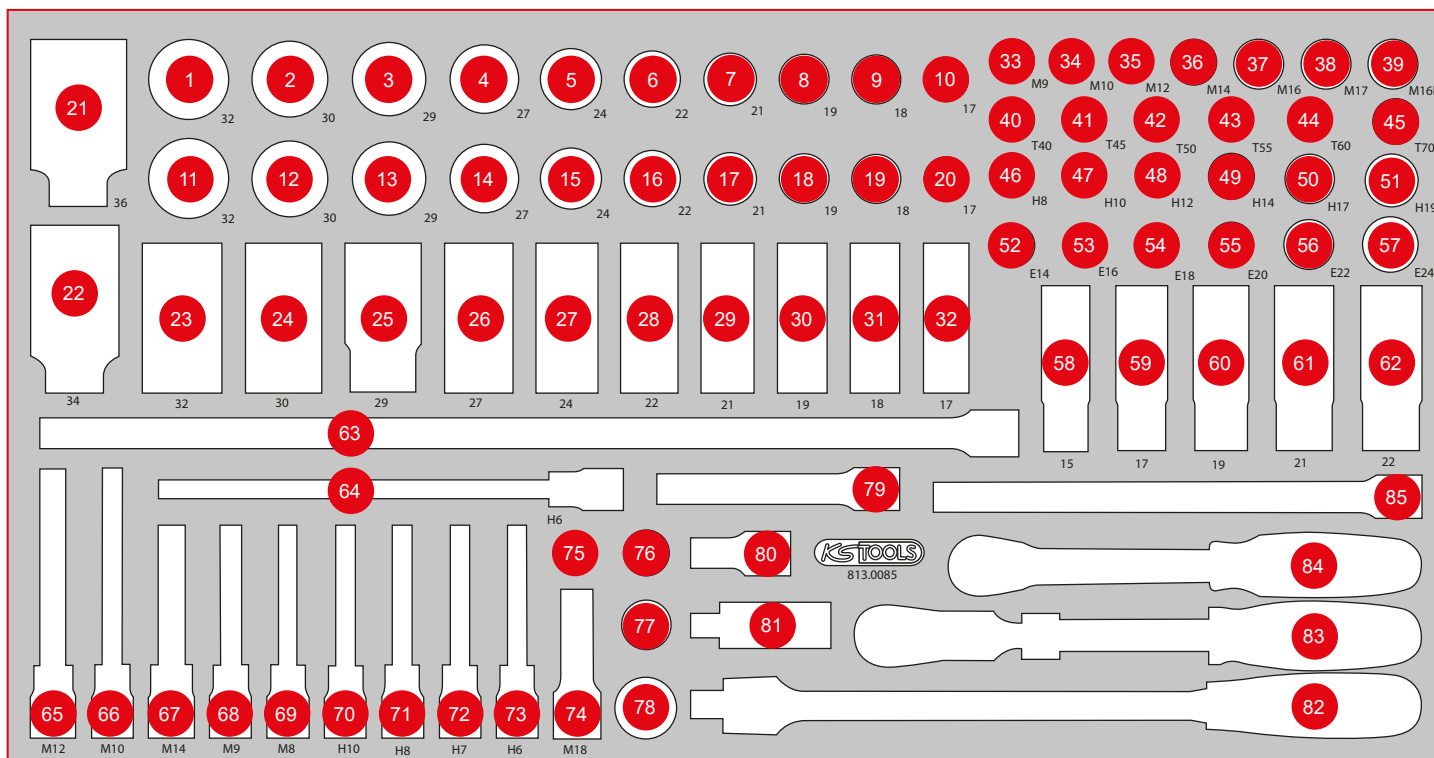

Pos.	Code	Description	pcs	Pos.	Code	Description	pcs	Pos.	Code	Description	pcs
48	911.1312	1/2" Bit socket hexagon, short, 12 mm	1	62	515.0995	SlimPOWER 1/2" Alloy rim impact socket, 22 mm	1	77	911.1234	Adaptor, 1/2" F x 3/4" M	1
49	911.1314	1/2" Bit socket hexagon, short, 14 mm	1	63	911.1836	Wobble extension, 1/2", 500 mm	1	78	911.3412	Reducing adaptor 3/4" F x 1/2" M	1
50	911.1317	1/2" Bit socket hexagon, short, 17 mm	1	64	911.5313	Hex bit socket, ball ended, long, 1/2", 6mm	1	79	911.1383	Wobble extension, 1/2", 125 mm	1
51	911.1319	1/2" Bit socket hexagon, short, 19 mm	1	65	911.1972	1/2" Bit socket spline (XZN), M12, 140 mm	1	80	911.1381	Wobble extension, 1/2", 50 mm	1
52	911.4336	1/2" Torx E Socket, E14	1	66	911.1970	1/2" Bit socket spline (XZN), M10, 140 mm	1	81	911.1250	1/2" Universal joint	1
53	911.4322	1/2" Torx E Socket, E16	1	67	911.1355	1/2" Bit socket spline (XZN), M14, 110 mm	1	82	917.1455	1/2" Flexi head drive handle	1
54	911.4323	1/2" Torx E Socket, E18	1	68	911.1359	1/2" Bit socket spline (XZN), M9, 110 mm	1	83	914.1220	1/2" SlimPOWER Telescopic reversible ratchet, 72 teeth	1
55	911.4324	1/2" Torx E Socket, E20	1	69	911.1352	1/2" Bit socket spline (XZN), M8, 110 mm	1	84	920.1290	1/2" SlimPOWER Reversible ratchet, 72 teeth	1
56	911.4325	1/2" Torx E Socket, E22	1	70	911.1660	Hex bit socket, ball ended, long, 1/2", 10 mm	1	85	911.1384	Wobble extension, 1/2", 250 mm	1
57	911.4326	1/2" Torx E Socket, E24	1	71	911.1658	Hex bit socket, ball ended, long, 1/2", 8 mm	1				
58	515.0991	SlimPOWER 1/2" Alloy rim impact socket, 15 mm	1	72	911.1657	Hex bit socket, ball ended, long, 1/2", 7 mm	1				
59	515.0992	SlimPOWER 1/2" Alloy rim impact socket, 17 mm	1	73	911.1656	Hex bit socket, ball ended, long, 1/2", 6mm	1				
60	515.0993	SlimPOWER 1/2" Alloy rim impact socket, 19 mm	1	74	515.1176	1/2" impact socket, XZN, M18 long	1				
61	515.0994	SlimPOWER 1/2" Alloy rim impact socket, 21 mm	1	75	911.3892	Adaptor, 3/8" F x 1/2" M	1				
				76	911.1207	3/8" Sliding adaptor, 3/8" F x 1/2" M	1				

P 10
P 15
P 20
P 25
P 30
P 35
P 40
P 45
S
XL
L
M
Individual parts
Accessories

813.0086

L 1/2" Socket spanner set

439,^{EUR}—



86

755 x 398 P25

Pos.	Code	Description	pcs	Pos.	Code	Description	pcs	Pos.	Code	Description	pcs
1	917.1252	1/2" Hexagonal socket, deep, 22 mm	1	16	917.1258	1/2" Hexagonal socket, deep, 20 mm	1	31	917.1343	1/2" Hexagonal socket, 26 mm	1
2	917.1315	1/2" Hexagonal socket, deep, 23 mm	1	17	917.1259	1/2" Hexagonal socket, deep, 21 mm	1	32	917.1227	1/2" Hexagonal socket, 27 mm	1
3	917.1257	1/2" Hexagonal socket, deep, 24 mm	1	18	917.1313	1/2" Hexagonal socket, deep, 8 mm	1	33	917.1344	1/2" Hexagonal socket, 28 mm	1
4	917.1337	1/2" Hexagonal socket, deep, 26 mm	1	19	917.1309	1/2" Hexagonal socket, deep, 9 mm	1	34	917.1230	1/2" Hexagonal socket, 30 mm	1
5	917.1254	1/2" Hexagonal socket, deep, 27 mm	1	20	917.1240	1/2" Hexagonal socket, deep, 10 mm	1	35	917.1232	1/2" Hexagonal socket, 32 mm	1
6	917.1338	1/2" Hexagonal socket, deep, 28 mm	1	21	917.1241	1/2" Hexagonal socket, deep, 11 mm	1	36	917.1221	1/2" Hexagonal socket, 21 mm	1
7	917.1255	1/2" Hexagonal socket, deep, 30 mm	1	22	917.1242	1/2" Hexagonal socket, deep, 12 mm	1	37	917.1220	1/2" Hexagonal socket, 20 mm	1
8	917.1256	1/2" Hexagonal socket, deep, 32 mm	1	23	515.0991	SlimPOWER 1/2" Alloy rim impact socket, 15 mm	1	38	917.1219	1/2" Hexagonal socket, 19 mm	1
9	917.1243	1/2" Hexagonal socket, deep, 13 mm	1	24	515.0992	SlimPOWER 1/2" Alloy rim impact socket, 17 mm	1	39	917.1218	1/2" Hexagonal socket, 18 mm	1
10	917.1244	1/2" Hexagonal socket, deep, 14 mm	1	25	515.0993	SlimPOWER 1/2" Alloy rim impact socket, 19 mm	1	40	917.1217	1/2" Hexagonal socket, 17 mm	1
11	917.1245	1/2" Hexagonal socket, deep, 15 mm	1	26	515.0994	SlimPOWER 1/2" Alloy rim impact socket, 21 mm	1	41	917.1216	1/2" Hexagonal socket, 16 mm	1
12	917.1246	1/2" Hexagonal socket, deep, 16 mm	1	27	515.0995	SlimPOWER 1/2" Alloy rim impact socket, 22 mm	1	42	917.1215	1/2" Hexagonal socket, 15 mm	1
13	917.1247	1/2" Hexagonal socket, deep, 17 mm	1	28	917.1222	1/2" Hexagonal socket, 22 mm	1	43	917.1214	1/2" Hexagonal socket, 14 mm	1
14	917.1248	1/2" Hexagonal socket, deep, 18 mm	1	29	917.1223	1/2" Hexagonal socket, 23 mm	1	44	917.1213	1/2" Hexagonal socket, 13 mm	1
15	917.1249	1/2" Hexagonal socket, deep, 19 mm	1	30	917.1224	1/2" Hexagonal socket, 24 mm	1	45	917.1212	1/2" Hexagonal socket, 12 mm	1

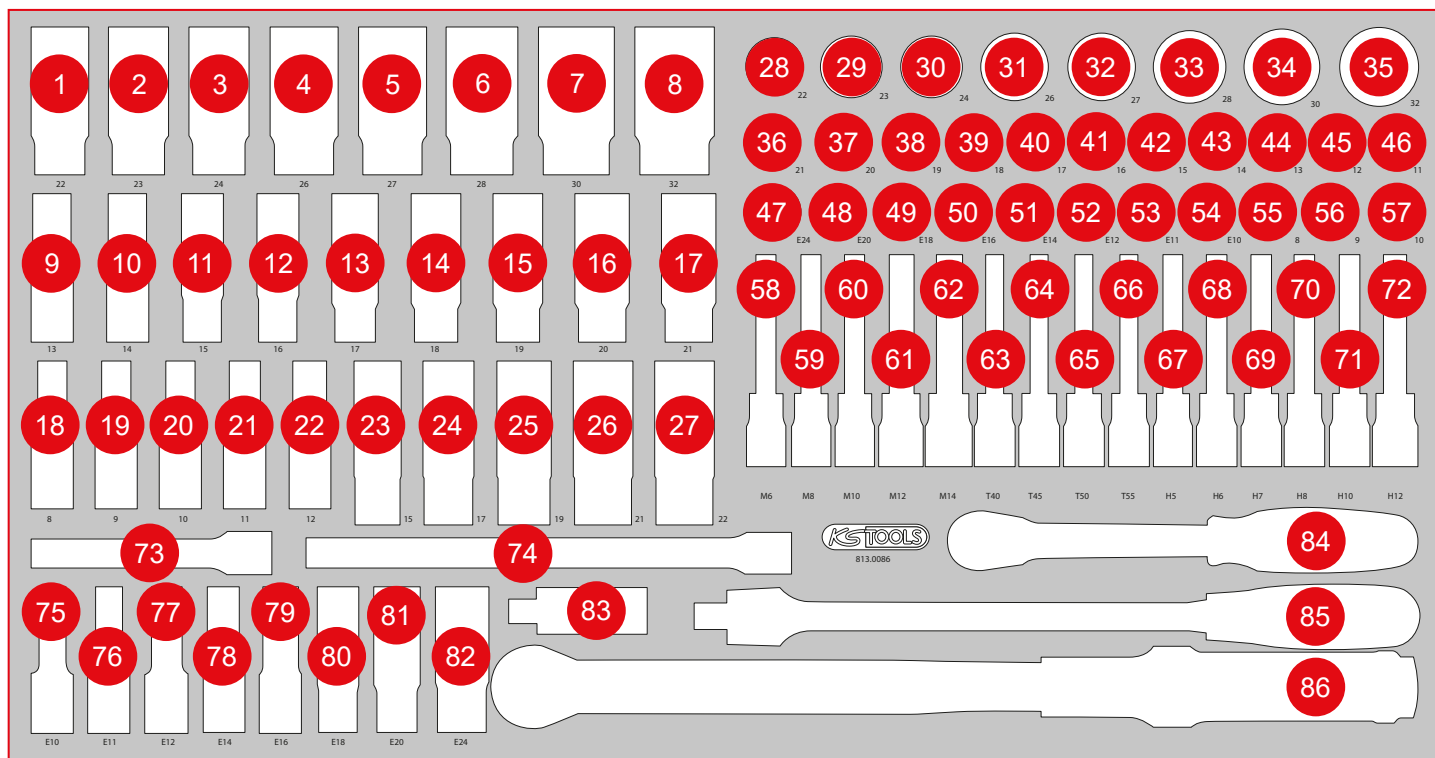

Pos.	Code	Description	pcs	Pos.	Code	Description	pcs	Pos.	Code	Description	pcs
46	917.1211	1/2" Hexagonal socket, 11 mm	1	61	911.1354	1/2" Bit socket spline (XZN), M12, 110 mm	1	75	911.4423	1/2" Torx E Socket, 78 mm long, E10	1
47	911.4326	1/2" Torx E Socket, E24	1	62	911.1355	1/2" Bit socket spline (XZN), M14, 110 mm	1	76	911.4424	1/2" Torx E Socket, deep, E11	1
48	911.4324	1/2" Torx E Socket, E20	1	63	911.1525	1/2" Bit socket Torx, long, T40	1	77	911.4425	1/2" Torx E Socket, 78 mm, E12	1
49	911.4323	1/2" Torx E Socket, E18	1	64	911.1526	1/2" Bit socket Torx, long, T45	1	78	911.4426	1/2" Torx E Socket, 78 mm, E14	1
50	911.4322	1/2" Torx E Socket, E16	1	65	911.1527	1/2" Bit socket Torx, long, T50	1	79	911.4427	1/2" Torx E Socket, 78 mm, E16	1
51	911.4336	1/2" Torx E Socket, E14	1	66	911.1528	1/2" Bit socket Torx, long, T55	1	80	911.4428	1/2" Torx E Socket, 78 mm, E18	1
52	911.4335	1/2" Torx E Socket, E12	1	67	911.1325	1/2" Bit socket hexagon, long, 5 mm	1	81	911.4429	1/2" Torx E Socket, 78 mm, E20	1
53	911.4334	1/2" Torx E Socket, E11	1	68	911.1326	1/2" Bit socket hexagon, long, 6 mm	1	82	911.4431	1/2" Torx E Socket, deep, E24	1
54	911.4333	1/2" Torx E Socket, E10	1	69	911.1327	1/2" Bit socket hexagon, long, 7 mm	1	83	911.1250	1/2" Universal joint	1
55	917.1340	1/2" Hexagonal socket, 8 mm	1	70	911.1328	1/2" Bit socket hexagon, long, 8 mm	1	84	516.1442	1/2" ERGOTORQUE® precision torque wrench with rotary mushroom ratchet head, 40-200Nm	1
56	917.1341	1/2" Hexagonal socket, 9 mm	1	71	911.1330	1/2" Bit socket hexagon, long, 10 mm	1	85	917.1455	1/2" Flexi head drive handle	1
57	917.1210	1/2" Hexagonal socket, 10 mm	1	72	911.1332	1/2" Bit socket hexagon, long, 12 mm	1	86	920.1290	1/2" SlimPOWER Reversible ratchet, 72 teeth	1
58	911.1351	1/2" Bit socket spline (XZN), M6, 110 mm	1	73	911.1202	1/2" Extensions, 125 mm	1				
59	911.1352	1/2" Bit socket spline (XZN), M8, 110 mm	1	74	911.1203	1/2" Extensions, 250 mm	1				
60	911.1353	1/2" Bit socket spline (XZN), M10, 110 mm	1								

P 10
P 15
P 20
P 25
P 30
P 35
P 40
P 45
Individual parts
S XL L M
Accessories

813.0117

L 1/2" Socket spanner set

469,^{EUR}—



117 PCS

755 x 398 P25

Pos.	Code	Description	pcs	Pos.	Code	Description	pcs	Pos.	Code	Description	pcs
1	920.1290	1/2" SlimPOWER Reversible ratchet, 72 teeth	1	21	917.1249	1/2" Hexagonal socket, deep, 19 mm	1	41	515.1030	1/2" Hexagon impact socket short, 30 mm	1
2	914.1225	Twister-ratchet-handle, 1/2", 60 teeth	1	22	917.1259	1/2" Hexagonal socket, deep, 21 mm	1	42	917.1210	1/2" Hexagonal socket, 10 mm	1
3	917.1425	1/2" Flexi head drive handle, 370 mm	1	23	515.1010	1/2" Hexagon impact socket short, 10 mm	1	43	917.1211	1/2" Hexagonal socket, 11 mm	1
4	911.1836	Wobble extension, 1/2", 500 mm	1	24	515.1011	1/2" Hexagon impact socket short, 11 mm	1	44	917.1212	1/2" Hexagonal socket, 12 mm	1
5	911.1202	1/2" Extensions, 125 mm	1	25	515.1012	1/2" Hexagon impact socket short, 12 mm	1	45	917.1213	1/2" Hexagonal socket, 13 mm	1
6	911.1203	1/2" Extensions, 250 mm	1	26	515.1013	1/2" Hexagon impact socket short, 13 mm	1	46	917.1214	1/2" Hexagonal socket, 14 mm	1
7	515.1176	1/2" impact socket, XZN, M18 long	1	27	515.1014	1/2" Hexagon impact socket short, 14 mm	1	47	917.1215	1/2" Hexagonal socket, 15 mm	1
8	911.1250	1/2" Universal joint	1	28	515.1015	1/2" Hexagon impact socket short, 15 mm	1	48	917.1216	1/2" Hexagonal socket, 16 mm	1
9	911.1381	Wobble extension, 1/2", 50 mm	1	29	515.1016	1/2" Hexagon impact socket short, 16 mm	1	49	917.1217	1/2" Hexagonal socket, 17 mm	1
10	150.1705	Special drive shaft impact socket, 1/2", 30 mm	1	30	515.1017	1/2" Hexagon impact socket short, 17 mm	1	50	917.1218	1/2" Hexagonal socket, 18 mm	1
11	150.1704	Special drive shaft impact socket, 1/2", 34 mm	1	31	515.1018	1/2" Hexagon impact socket short, 18 mm	1	51	917.1219	1/2" Hexagonal socket, 19 mm	1
12	150.1707	Special drive shaft impact socket, 1/2", 36 mm	1	32	515.1019	1/2" Hexagon impact socket short, 19 mm	1	52	917.1220	1/2" Hexagonal socket, 20 mm	1
13	515.0991	SlimPOWER 1/2"Alloy rim impact socket, 15 mm	1	33	515.1020	1/2" Hexagon impact socket short, 20 mm	1	53	917.1221	1/2" Hexagonal socket, 21 mm	1
14	515.0992	SlimPOWER 1/2"Alloy rim impact socket, 17mm	1	34	515.1021	1/2" Hexagon impact socket short, 21 mm	1	54	917.1222	1/2" Hexagonal socket, 22 mm	1
15	515.0993	SlimPOWER 1/2"Alloy rim impact socket, 19 mm	1	35	515.1022	1/2" Hexagon impact socket short, 22 mm	1	55	917.1223	1/2" Hexagonal socket, 23 mm	1
16	515.0994	SlimPOWER 1/2"Alloy rim impact socket, 21 mm	1	36	515.1024	1/2" Hexagon impact socket short, 24 mm	1	56	917.1224	1/2" Hexagonal socket, 24 mm	1
17	515.0995	SlimPOWER 1/2"Alloy rim impact socket, 22 mm	1	37	515.1025	1/2" Hexagon impact socket short, 25 mm	1	57	917.1342	1/2" Hexagonal socket, 25 mm	1
18	917.1240	1/2" Hexagonal socket, deep, 10 mm	1	38	515.1027	1/2" Hexagon impact socket short, 27 mm	1	58	917.1343	1/2" Hexagonal socket, 26 mm	1
19	917.1243	1/2" Hexagonal socket, deep, 13 mm	1	39	515.1028	1/2" Hexagon impact socket short, 28 mm	1	59	917.1227	1/2" Hexagonal socket, 27 mm	1
20	917.1247	1/2" Hexagonal socket, deep, 17 mm	1	40	515.1029	1/2" Hexagon impact socket short, 29 mm	1	60	917.1344	1/2" Hexagonal socket, 28 mm	1

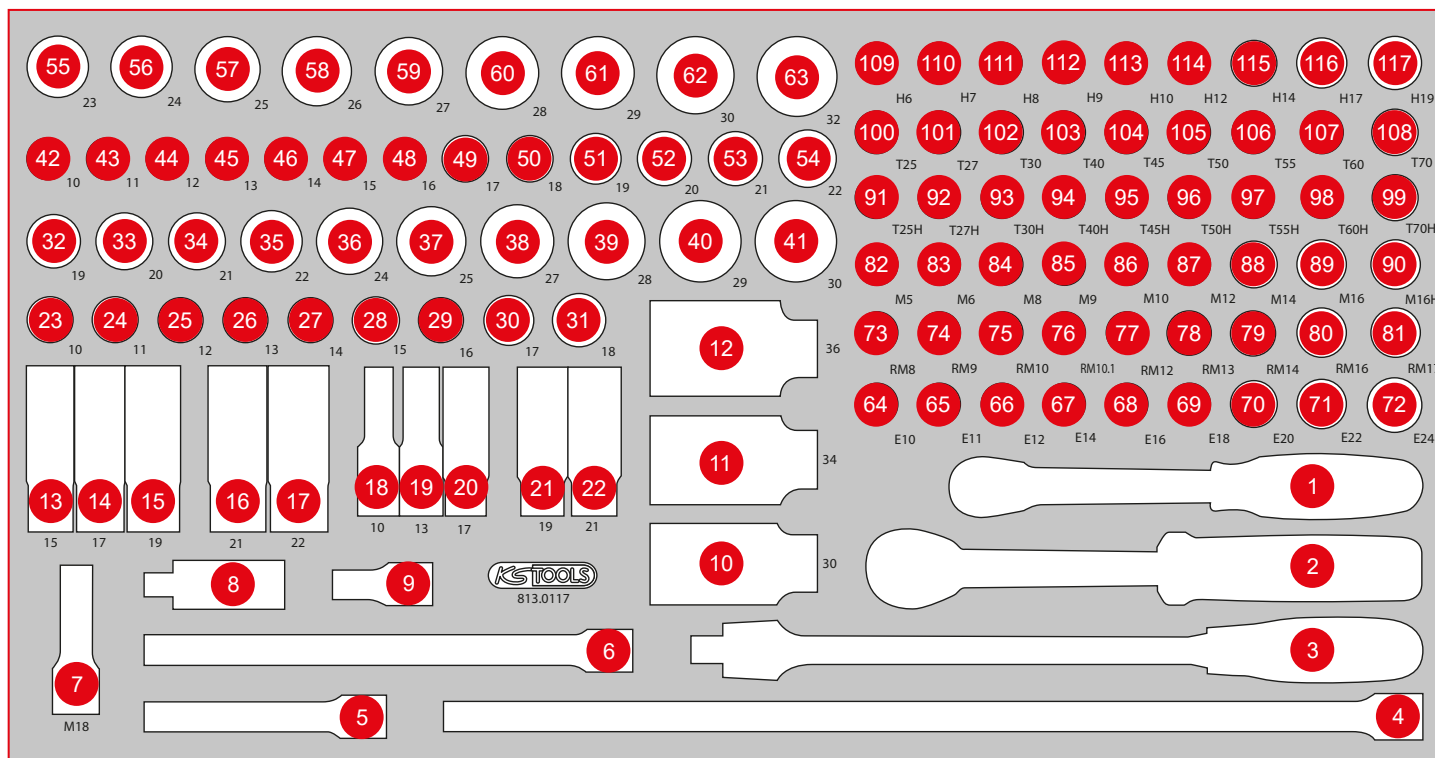

Pos.	Code	Description	pcs	Pos.	Code	Description	pcs	Pos.	Code	Description	pcs
61	917.1345	1/2" Hexagonal socket, 29 mm	1	81	911.5306	1/2" Bit socket spline (XZN), M17, 55 mm	1	100	911.1362	1/2" Bit socket Torx, T25	1
62	917.1230	1/2" Hexagonal socket, 30 mm	1	82	911.1340	1/2" Bit socket spline (XZN), M5, 55 mm	1	101	911.1363	1/2" Bit socket Torx, T27	1
63	917.1232	1/2" Hexagonal socket, 32 mm	1	83	911.1341	1/2" Bit socket spline (XZN), M6, 55 mm	1	102	911.1364	1/2" Bit socket Torx, T30	1
64	911.4333	1/2" Torx E Socket, E10	1	84	911.1342	1/2" Bit socket spline (XZN), M8, 55 mm	1	103	911.1365	1/2" Bit socket Torx, T40	1
65	911.4334	1/2" Torx E Socket, E11	1	85	911.1313	1/2" Bit socket spline (XZN), M9, 55 mm	1	104	911.1366	1/2" Bit socket Torx, T45	1
66	911.4335	1/2" Torx E Socket, E12	1	86	911.1343	1/2" Bit socket spline (XZN), M10, 55 mm	1	105	911.1367	1/2" Bit socket Torx, T50	1
67	911.4336	1/2" Torx E Socket, E14	1	87	911.1344	1/2" Bit socket spline (XZN), M12, 55 mm	1	106	911.1368	1/2" Bit socket Torx, T55	1
68	911.4322	1/2" Torx E Socket, E16	1	88	911.1345	1/2" Bit socket spline (XZN), M14, 55 mm	1	107	911.1369	1/2" Bit socket Torx, T60	1
69	911.4323	1/2" Torx E Socket, E18	1	89	911.1346	1/2" Bit socket spline (XZN), M16, 55 mm	1	108	911.1370	1/2" Bit socket Torx, T70	1
70	911.4324	1/2" Torx E Socket, E20	1	90	911.1348	1/2" Bit socket spline (XZN) tamperproof, M16, 55 mm	1	109	911.1306	1/2" Bit socket hexagon, short, 6 mm	1
71	911.4325	1/2" Torx E Socket, E22	1	91	911.1372	1/2" Bit socket Torx tamperproof, TB25	1	110	911.1307	1/2" Bit socket hexagon, short, 7 mm	1
72	911.4326	1/2" Torx E Socket, E24	1	92	911.1373	1/2" Bit socket Torx tamperproof, TB27	1	111	911.1308	1/2" Bit socket hexagon, short, 8 mm	1
73	911.4514	Bit socket for RIBE screws, M8, length 55 mm	1	93	911.1374	1/2" Bit socket Torx tamperproof, TB30	1	112	911.1309	1/2" Bit socket hexagon, short, 9 mm	1
74	911.4515	Bit socket for RIBE screws, M9, length 55 mm	1	94	911.1375	1/2" Bit socket Torx tamperproof, TB40	1	113	911.1310	1/2" Bit socket hexagon, short, 10 mm	1
75	911.4516	Bit socket for RIBE screws, M10, length 55 mm	1	95	911.1376	1/2" Bit socket Torx tamperproof, TB45	1	114	911.1312	1/2" Bit socket hexagon, short, 12 mm	1
76	911.4551	Bit socket for RIBE screws, M10.1, length 55 mm	1	96	911.1377	1/2" Bit socket Torx tamperproof, TB50	1	115	911.1314	1/2" Bit socket hexagon, short, 14 mm	1
77	911.4517	Bit socket for RIBE screws, M12, length 55 mm	1	97	911.1378	1/2" Bit socket Torx tamperproof, TB55	1	116	911.1317	1/2" Bit socket hexagon, short, 17 mm	1
78	911.4518	Bit socket for RIBE screws, M13, length 55 mm	1	98	911.1379	1/2" Bit socket Torx tamperproof, TB60	1	117	911.1319	1/2" Bit socket hexagon, short, 19 mm	1
79	911.4519	Bit socket for RIBE screws, M14, length 55 mm	1	99	911.1380	1/2" Bit socket Torx tamperproof, TB70	1				
80	911.4552	Bit socket for RIBE screws, M16, length 55 mm	1								

P 10
P 15
P 20
P 25
P 30
P 35
P 40
P 45
Individual parts S XL L M
Accessories

813.0120

L 1/2" Socket spanner set

529,^{EUR}-



120

755 x 398 P25

Pos.	Code	Description	pcs	Pos.	Code	Description	pcs	Pos.	Code	Description	pcs
1	917.1223	1/2" Hexagonal socket, 23 mm	1	22	917.1213	1/2" Hexagonal socket, 13 mm	1	43	911.4336	1/2" Torx E Socket, E14	1
2	917.1224	1/2" Hexagonal socket, 24 mm	1	23	917.1214	1/2" Hexagonal socket, 14 mm	1	44	911.4322	1/2" Torx E Socket, E16	1
3	917.1343	1/2" Hexagonal socket, 26 mm	1	24	911.4513	Bit socket for RIBE screws, M7, Length 55 mm	1	45	911.4323	1/2" Torx E Socket, E18	1
4	917.1227	1/2" Hexagonal socket, 27 mm	1	25	911.4514	Bit socket for RIBE screws, M8, length 55 mm	1	46	911.4324	1/2" Torx E Socket, E20	1
5	917.1344	1/2" Hexagonal socket, 28 mm	1	26	911.4515	Bit socket for RIBE screws, M9, length 55 mm	1	47	911.4325	1/2" Torx E Socket, E22	1
6	917.1230	1/2" Hexagonal socket, 30 mm	1	27	911.4516	Bit socket for RIBE screws, M10, Length 55 mm	1	48	911.1363	1/2" Bit socket Torx, T27	1
7	917.1232	1/2" Hexagonal socket, 32 mm	1	28	911.4517	Bit socket for RIBE screws, M12, Length 55 mm	1	49	911.1364	1/2" Bit socket Torx, T30	1
8	917.1215	1/2" Hexagonal socket, 15 mm	1	29	911.4518	Bit socket for RIBE screws, M13, Length 55 mm	1	50	911.1365	1/2" Bit socket Torx, T40	1
9	917.1216	1/2" Hexagonal socket, 16 mm	1	30	911.4519	Bit socket for RIBE screws, M14, Length 55 mm	1	51	911.1366	1/2" Bit socket Torx, T45	1
10	917.1217	1/2" Hexagonal socket, 17 mm	1	31	911.4552	Bit socket for RIBE screws, M16, Length 55 mm	1	52	911.1367	1/2" Bit socket Torx, T50	1
11	917.1218	1/2" Hexagonal socket, 18 mm	1	32	911.1305	1/2" Bit socket hexagon, short, 5 mm	1	53	911.1368	1/2" Bit socket Torx, T55	1
12	917.1219	1/2" Hexagonal socket, 19 mm	1	33	911.1306	1/2" Bit socket hexagon, short, 6 mm	1	54	911.1369	1/2" Bit socket Torx, T60	1
13	917.1220	1/2" Hexagonal socket, 20 mm	1	34	911.1307	1/2" Bit socket hexagon, short, 7 mm	1	55	911.1370	1/2" Bit socket Torx, T70	1
14	917.1221	1/2" Hexagonal socket, 21 mm	1	35	911.1308	1/2" Bit socket hexagon, short, 8 mm	1	56	911.1373	1/2" Bit socket Torx tamperproof, TB27	1
16	911.1207	Sliding adaptor, 3/8" F x 1/2" M	1	36	911.1309	1/2" Bit socket hexagon, short, 9 mm	1	57	911.1374	1/2" Bit socket Torx tamperproof, TB30	1
17	917.1340	1/2" Hexagonal socket, 8 mm	1	37	911.1310	1/2" Bit socket hexagon, short, 10 mm	1	58	911.1375	1/2" Bit socket Torx tamperproof, TB40	1
18	917.1341	1/2" Hexagonal socket, 9 mm	1	38	911.1312	1/2" Bit socket hexagon, short, 12 mm	1	59	911.1376	1/2" Bit socket Torx tamperproof, TB45	1
19	917.1210	1/2" Hexagonal socket, 10 mm	1	39	911.1314	1/2" Bit socket hexagon, short, 14 mm	1	60	911.1377	1/2" Bit socket Torx tamperproof, TB50	1
20	917.1211	1/2" Hexagonal socket, 11 mm	1	40	911.4333	1/2" Torx E Socket, E10	1	61	911.1378	1/2" Bit socket Torx tamperproof, TB55	1
21	917.1212	1/2" Hexagonal socket, 12 mm	1	41	911.4334	1/2" Torx E Socket, E11	1	62	911.1379	1/2" Bit socket Torx tamperproof, TB60	1
22	917.1222	1/2" Hexagonal socket, 22 mm	1	42	911.4335	1/2" Torx E Socket, E12	1	63	911.1380	1/2" Bit socket Torx tamperproof, TB70	1

813.0156

L 1/4" + 3/8" + 1/2" Socket spanner set

389,^{EUR}—



1PCS
156

755 x 398
P25

Pos.	Code	Description	pcs	Pos.	Code	Description	pcs	Pos.	Code	Description	pcs
1	911.3863	3/8" Bit socket hexagon, 3 mm	1	27	911.3969	3/8" Bit socket Torx tamperproof, TB55	1	53	911.4321	3/8" Torx E Socket, E14	1
2	911.3864	3/8" Bit socket hexagon, 4 mm	1	28	917.3815	3/8" Hexagonal socket, 15 mm	1	54	917.1222	1/2" Hexagonal socket, 22 mm	1
3	911.3865	3/8" Bit socket hexagon, 5 mm	1	29	917.3816	3/8" Hexagonal socket, 16 mm	1	55	917.1223	1/2" Hexagonal socket, 23 mm	1
4	911.38655	3/8" Bit socket hexagon, 5,5 mm	1	30	917.3817	3/8" Hexagonal socket, 17 mm	1	56	917.1224	1/2" Hexagonal socket, 24 mm	1
5	911.3866	3/8" Bit socket hexagon, 6 mm	1	31	917.3818	3/8" Hexagonal socket, 18 mm	1	57	917.1342	1/2" Hexagonal socket, 25 mm	1
6	911.3867	3/8" Bit socket hexagon, 7 mm	1	32	917.3819	3/8" Hexagonal socket, 19 mm	1	58	917.1343	1/2" Hexagonal socket, 26 mm	1
7	911.3868	3/8" Bit socket hexagon, 8 mm	1	33	917.3820	3/8" Hexagonal socket, 20 mm	1	59	917.1227	1/2" Hexagonal socket, 27 mm	1
8	917.3969	3/8" Bit socket hexagon, 9 mm	1	34	917.3821	3/8" Hexagonal socket, 21 mm	1	60	917.1344	1/2" Hexagonal socket, 28 mm	1
9	917.3857	3/8" Bit socket hexagon, 10 mm	1	35	917.3822	3/8" Hexagonal socket, 22 mm	1	61	917.1345	1/2" Hexagonal socket, 29 mm	1
10	911.3869	3/8" Bit socket Torx, T15	1	36	917.3806	3/8" Hexagonal socket, 6 mm	1	62	917.1230	1/2" Hexagonal socket, 30 mm	1
11	911.3870	3/8" Bit socket Torx, T20	1	37	917.3807	3/8" Hexagonal socket, 7 mm	1	63	917.1232	1/2" Hexagonal socket, 32 mm	1
12	911.3871	3/8" Bit socket Torx, T25	1	38	917.3808	3/8" Hexagonal socket, 8 mm	1	64	917.1210	1/2" Hexagonal socket, 10 mm	1
13	911.3872	3/8" Bit socket Torx, T27	1	39	917.3809	3/8" Hexagonal socket, 9 mm	1	65	917.1211	1/2" Hexagonal socket, 11 mm	1
14	911.3873	3/8" Bit socket Torx, T30	1	40	917.3810	3/8" Hexagonal socket, 10 mm	1	66	917.1212	1/2" Hexagonal socket, 12 mm	1
15	911.3874	3/8" Bit socket Torx, T40	1	41	917.3811	3/8" Hexagonal socket, 11 mm	1	67	917.1213	1/2" Hexagonal socket, 13 mm	1
16	911.3885	3/8" Bit socket Torx, T45	1	42	917.3812	3/8" Hexagonal socket, 12 mm	1	68	917.1214	1/2" Hexagonal socket, 14 mm	1
17	911.3884	3/8" Bit socket Torx, T50	1	43	917.3813	3/8" Hexagonal socket, 13 mm	1	69	917.1215	1/2" Hexagonal socket, 15 mm	1
18	911.3888	3/8" Bit socket Torx, T55	1	44	917.3814	3/8" Hexagonal socket, 14 mm	1	70	917.1216	1/2" Hexagonal socket, 16 mm	1
19	911.3961	3/8" Bit socket Torx tamperproof, TB15	1	45	911.4338	3/8" Torx E Socket, E4	1	71	917.1217	1/2" Hexagonal socket, 17 mm	1
20	911.3962	3/8" Bit socket Torx tamperproof, TB20	1	46	911.4339	3/8" Torx E Socket, E5	1	72	917.1218	1/2" Hexagonal socket, 18 mm	1
21	911.3963	3/8" Bit socket Torx tamperproof, TB25	1	47	911.4340	3/8" Torx E Socket, E6	1	73	917.1219	1/2" Hexagonal socket, 19 mm	1
22	911.3964	3/8" Bit socket Torx tamperproof, TB27	1	48	911.4341	3/8" Torx E Socket, E7	1	74	917.1220	1/2" Hexagonal socket, 20 mm	1
23	911.3965	3/8" Bit socket Torx tamperproof, TB30	1	49	911.4342	3/8" Torx E Socket, E8	1	75	917.1221	1/2" Hexagonal socket, 21 mm	1
24	911.3966	3/8" Bit socket Torx tamperproof, TB40	1	50	911.4318	3/8" Torx E Socket, E10	1	76	917.1340	1/2" Hexagonal socket, 8 mm	1
25	911.3967	3/8" Bit socket Torx tamperproof, TB45	1	51	911.4319	3/8" Torx E Socket, E11	1	77	917.1341	1/2" Hexagonal socket, 9 mm	1
26	911.3968	3/8" Bit socket Torx tamperproof, TB50	1	52	911.4320	3/8" Torx E Socket, E12	1	78	911.1233	1/2" Reducing adaptor, 1/2" F x 3/8" M	1

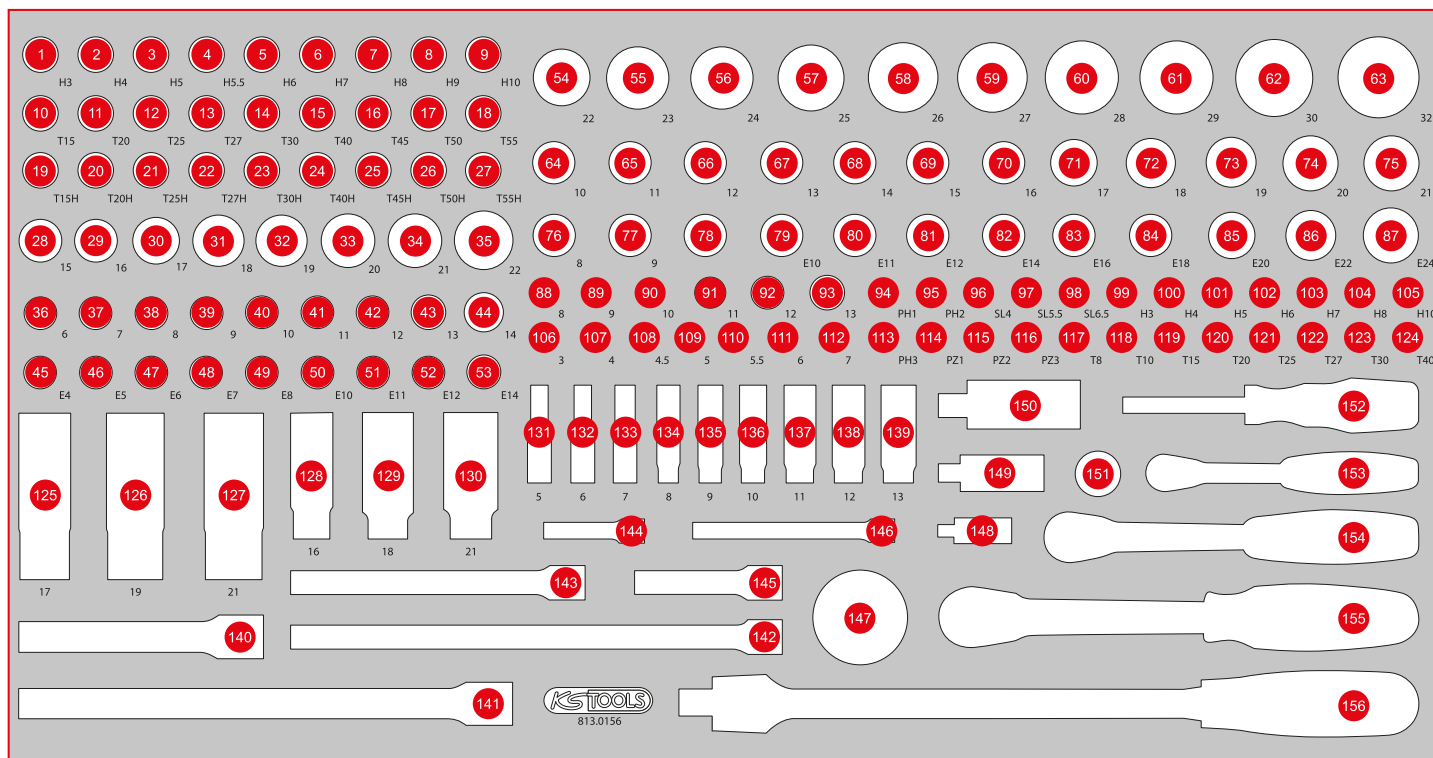

Pos.	Code	Description	pcs	Pos.	Code	Description	pcs	Pos.	Code	Description	pcs
79	911.4333	1/2" Torx E Socket, E10	1	106	917.1445	1/4" Classic Hexagonal socket, 3 mm	1	131	917.1527	1/4" Hexagonal socket, deep, 5 mm	1
80	911.4334	1/2" Torx E Socket, E11	1	107	917.1404	1/4" Hexagonal socket, 4 mm	1	132	917.1426	1/4" Hexagonal socket, deep, 6 mm	1
81	911.4335	1/2" Torx E Socket, E12	1	108	917.14045	1/4" Hexagonal socket, 4.5 mm	1	133	917.1427	1/4" Hexagonal socket, deep, 7 mm	1
82	911.4336	1/2" Torx E Socket, E14	1	109	917.1405	1/4" Hexagonal socket, 5 mm	1	134	917.1428	1/4" Hexagonal socket, deep, 8 mm	1
83	911.4322	1/2" Torx E Socket, E16	1	110	917.14055	1/4" Hexagonal socket, 5.5 mm	1	135	917.1429	1/4" Hexagonal socket, deep, 9 mm	1
84	911.4323	1/2" Torx E Socket, E18	1	111	917.1406	1/4" Hexagonal socket, 6 mm	1	136	917.1430	1/4" Hexagonal socket, deep, 10 mm	1
85	911.4324	1/2" Torx E Socket, E20	1	112	917.1407	1/4" Hexagonal socket, 7 mm	1	137	917.1431	1/4" Hexagonal socket, deep, 11 mm	1
86	911.4325	1/2" Torx E Socket, E22	1	113	911.1417	1/4" Bit socket, PH3	1	138	917.1432	1/4" Hexagonal socket, deep, 12 mm	1
87	911.4326	1/2" Torx E Socket, E24	1	114	911.1401	1/4" Bit socket, PZ1	1	139	917.1433	1/4" Hexagonal socket, deep, 13 mm	1
88	917.1408	1/4" Hexagonal socket, 8 mm	1	115	911.1402	1/4" Bit socket, PZ2	1	140	911.1202	1/2" Extensions, 125 mm	1
89	917.1409	1/4" Hexagonal socket, 9 mm	1	116	911.1403	1/4" Bit socket, PZ3	1	141	911.1203	1/2" Extensions, 250 mm	1
90	917.1410	1/4" Hexagonal socket, 10 mm	1	117	911.1448	1/4" Bit socket Torx, T8	1	142	911.3803	3/8" Extensions 250 mm	1
91	917.1411	1/4" Hexagonal socket, 11 mm	1	118	911.1442	1/4" Bit socket Torx, T10	1	143	911.3802	3/8" Extensions 150 mm	1
92	917.1412	1/4" Hexagonal socket, 12 mm	1	119	911.1443	1/4" Bit socket Torx, T15	1	144	911.1423	1/4" Extension with hexagon drive, 50mm	1
93	917.1413	1/4" Hexagonal socket, 13 mm	1	120	911.1444	1/4" Bit socket Torx, T20	1	145	911.3801	3/8" Extensions 75 mm	1
94	911.1415	1/4" Bit socket, PH1	1	121	911.1445	1/4" Bit socket Torx, T25	1	146	911.1424	1/4" Extension with hexagon drive, 100mm	1
95	911.1416	1/4" Bit socket, PH2	1	122	911.1449	1/4" Bit socket Torx, T27	1	147	914.3810	3/8" HandReversible ratchet	1
96	911.1418	1/4" Bit socket slot, 4 mm	1	123	911.1446	1/4" Bit socket Torx, T30	1	148	911.1450	1/4" Universal joint	1
97	911.1419	1/4" Bit socket slot, 5.5 mm	1	124	911.1447	1/4" Bit socket Torx, T40	1	149	911.3850	3/8" Universal joint	1
98	917.1421	1/4" Bit socket slot, 6.5 mm	1	125	515.0992	SlimPOWER 1/2"Alloy rim impact socket, 17 mm	1	150	911.1250	1/2" Universal joint	1
99	911.1436	1/4" Bit socket hexagon, 3 mm	1	126	515.0993	SlimPOWER 1/2"Alloy rim impact socket, 19 mm	1	151	911.1207	3/8" Sliding adaptor, 3/8"Fx1/2"M	1
100	911.1437	1/4" Bit socket hexagon, 4 mm	1	127	515.0994	SlimPOWER 1/2"Alloy rim impact socket, 21 mm	1	152	911.1434	1/4" Square drive screwdriver, 150 mm	1
101	911.1438	1/4" Bit socket hexagon, 5 mm	1	128	911.3804	3/8" Spark plug socket, 16 mm	1	153	920.1490	1/4" SlimPOWER Reversible ratchet, 72 teeth	1
102	911.1439	1/4" Bit socket hexagon, 6 mm	1	129	911.3823	3/8" Spark plug socket, 18 mm	1	154	920.3890	3/8" SlimPOWER Reversible ratchet, 72 teeth	1
103	911.1440	1/4" Bit socket hexagon, 7 mm	1	130	911.3805	3/8" Spark plug socket, 21 mm	1	155	920.1290	1/2" SlimPOWER Reversible ratchet, 72 teeth	1
104	911.1441	1/4" Bit socket hexagon, 8 mm	1					156	917.1455	1/2" Flexi head drive handle	1
105	917.1452	1/4" Bit socket hexagon, 10 mm	1								

813.0033

L Screwdriver set

179,^{EUR}—



755 x 398

P25

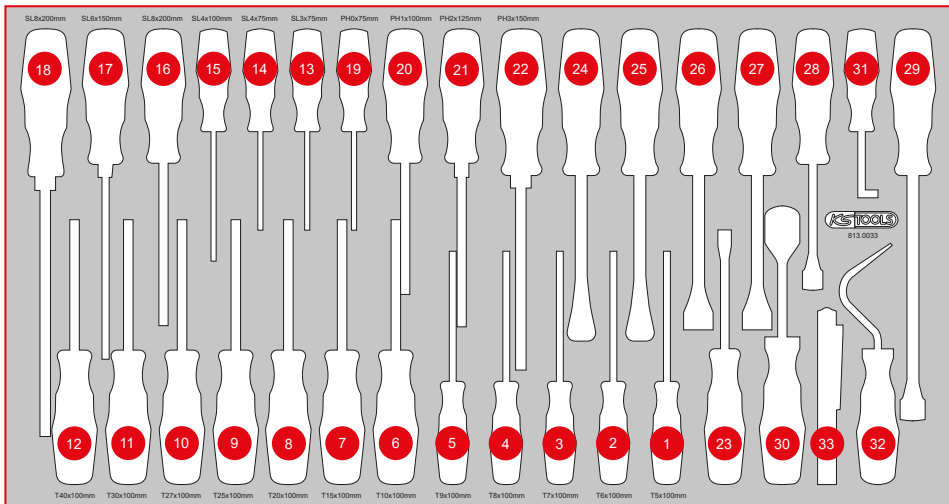
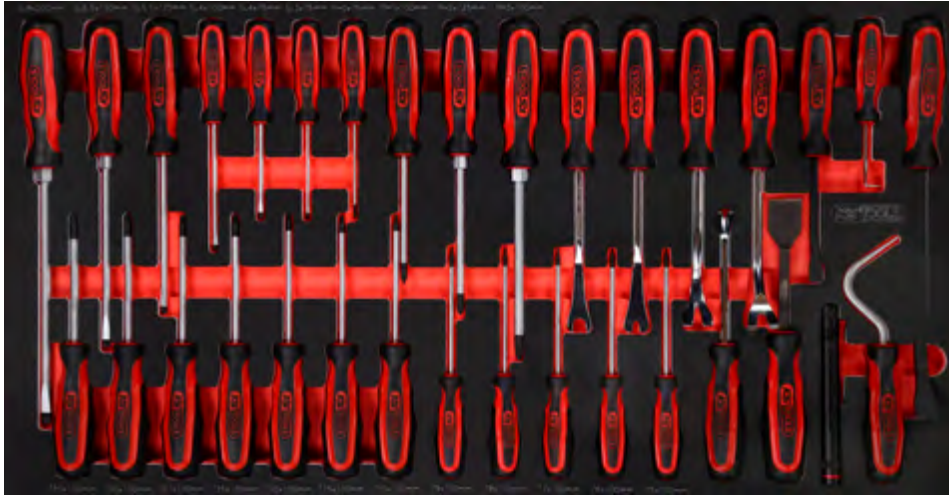

Pos.	Code	Description	pcs
1	159.1133	ERGOTORQUEplus screwdriver, Torx, T5	1
2	159.1134	ERGOTORQUEplus screwdriver, Torx, T6	1
3	159.1135	ERGOTORQUEplus screwdriver, Torx, T7	1
4	159.1030	ERGOTORQUEplus screwdriver, Torx, T8	1
5	159.1031	ERGOTORQUEplus screwdriver, Torx, T9	1
6	159.1032	ERGOTORQUEplus screwdriver, Torx, T10	1
7	159.1033	ERGOTORQUEplus screwdriver, Torx, T15	1
8	159.1034	ERGOTORQUEplus screwdriver, Torx, T20	1
9	159.1035	ERGOTORQUEplus screwdriver, Torx, T25	1
10	159.1036	ERGOTORQUEplus screwdriver, Torx, T27	1
11	159.1037	ERGOTORQUEplus screwdriver, Torx, T30	1
12	159.1038	ERGOTORQUEplus screwdriver, Torx, T40	1
13	159.1002	ERGOTORQUEplus screwdriver for slotted screws, 3 mm, 155 mm long	1
14	159.1003	ERGOTORQUEplus screwdriver for slotted screws, 4 mm, 155 mm long	1
15	159.1004	ERGOTORQUEplus screwdriver for slotted screws, 4 mm, 180 mm long	1
16	159.1006	ERGOTORQUEplus screwdriver for slotted screws, 5,5 mm, 230 mm long	1
17	159.1009	ERGOTORQUEplus screwdriver for slotted screws, 6,5 mm, 255 mm long	1
18	159.1011	ERGOTORQUEplus screwdriver for slotted screws, 8 mm, 315 mm long	1
19	159.1027	ERGOTORQUEplus screwdriver, Torx, PH0, 155 mm	1
20	159.1029	ERGOTORQUEplus screwdriver, Torx, PH1, 205 mm	1
21	159.1022	ERGOTORQUEplus screwdriver, Torx, PH2, 230 mm	1
22	159.1024	ERGOTORQUEplus screwdriver, Torx, PH3, 265 mm	1
23	140.2617	Clip remover short, length 240 mm, opening 5 mm	1
24	140.2373	Clip remover short, length 245 mm, opening 10 mm	1
25	140.2371	Clip remover short, length 245 mm, opening 4 mm	1
26	140.2616	Clip remover, short 7,5 mm	1
27	140.2615	Clip remover, short 9 mm	1
28	911.8101	Pry bar, 11 x 115 mm	1
29	911.8102	Pry bar, 15 x 185 mm	1
30	907.2232	Gasket scraper, 25 x 200 mm	1
31	550.1048	Hook, 90° offset	1
32	550.1073	Hook, large, sickle	1
33	150.4370	perfectLight torch 85 lumen	1

813.1033

L Screwdriver set

199, ^{EUR}—

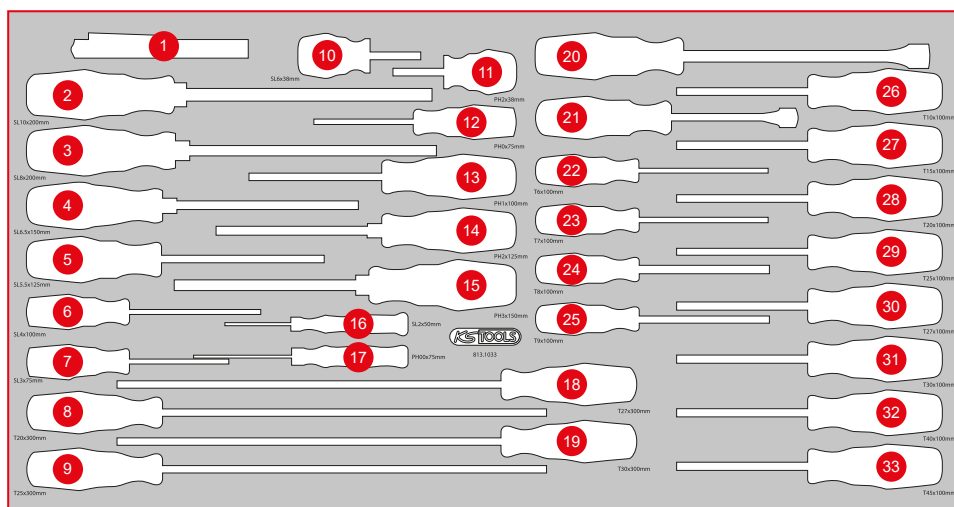

Pos.	Code	Description	pcs
1	150.4370	perfectLight torch 85 lumen	1
2	159.1012	ERGOTORQUEplus screwdriver for slotted screws, 10 mm, 315 mm long	1
3	159.1011	ERGOTORQUEplus screwdriver for slotted screws, 8 mm, 315 mm long	1
4	159.1009	ERGOTORQUEplus screwdriver for slotted screws, 6,5 mm, 255 mm long	1
5	159.1006	ERGOTORQUEplus screwdriver for slotted screws, 5,5 mm, 230 mm long	1
6	159.1004	ERGOTORQUEplus screwdriver for slotted screws, 4 mm, 180 mm long	1
7	159.1002	ERGOTORQUEplus screwdriver for slotted screws, 3 mm, 155 mm long	1
8	159.1261	ERGOTORQUEplus screwdriver, Torx, T20, long	1
9	159.1262	ERGOTORQUEplus screwdriver, Torx, T25, long	1
10	159.1001	ERGOTORQUEplus screwdriver for slotted screws, short, 6 mm	1
11	159.1026	ERGOTORQUEplus screwdriver, Torx, short, PH2	1
12	159.1027	ERGOTORQUEplus screwdriver, Torx, PH0, 155 mm	1
13	159.1029	ERGOTORQUEplus screwdriver, Torx, PH1, 205 mm	1
14	159.1022	ERGOTORQUEplus screwdriver, Torx, PH2, 230 mm	1
15	159.1024	ERGOTORQUEplus screwdriver, Torx, PH3, 265 mm	1
16	500.7109	Precision screwdriver, slot, 2 mm	1
17	500.7831	Precision screwdriver, PHILLIPS, PH00 x 2,0 mm	1
18	159.1263	ERGOTORQUEplus screwdriver, Torx, T27, long	1
19	159.1264	ERGOTORQUEplus screwdriver, Torx, T30, long	1
20	911.8102	Pry bar, 15 x 185 mm	1
21	911.8101	Pry bar, 11 x 115 mm	1
22	159.1134	ERGOTORQUEplus screwdriver, Torx, T6	1
23	159.1135	ERGOTORQUEplus screwdriver, Torx, T7	1
24	159.1030	ERGOTORQUEplus screwdriver, Torx, T8	1
25	159.1031	ERGOTORQUEplus screwdriver, Torx, T9	1
26	159.1032	ERGOTORQUEplus screwdriver, Torx, T10	1
27	159.1033	ERGOTORQUEplus screwdriver, Torx, T15	1
28	159.1034	ERGOTORQUEplus screwdriver, Torx, T20	1
29	159.1035	ERGOTORQUEplus screwdriver, Torx, T25	1
30	159.1036	ERGOTORQUEplus screwdriver, Torx, T27	1
31	159.1037	ERGOTORQUEplus screwdriver, Torx, T30	1
32	159.1038	ERGOTORQUEplus screwdriver, Torx, T40	1
33	159.1136	ERGOTORQUEplus screwdriver, Torx, T45	1

P 10

P 15

P 20

P 25

P 30

P 35

P 40

P 45

L M

S XL

Individual parts

Accessories

813.0042

L Screwdriver and file set

229, ^{EUR}—

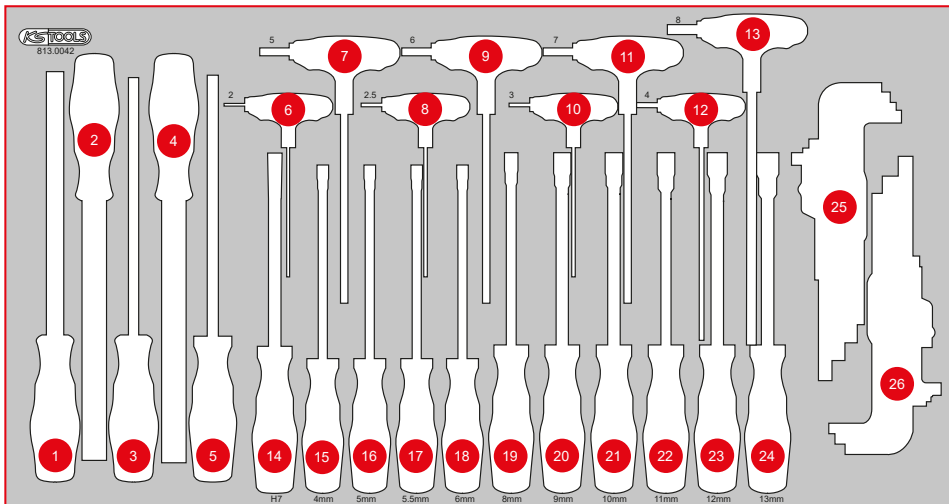

Pos.	Code	Description	pcs
1	157.0405	Tri-bastard file, form C, cut 2, 200 mm	1
2	157.0105	Halfround file, form E, cut 2, 20 mm	1
3	157.0305	Square file, form D, cut2, 200mm	1
4	157.0005	Flat file, form B, cut 2, 200 mm	1
5	157.0205	Round file, form F, cut 2, 200 mm	1
6	151.8130	T-handle ball ended hexagon key wrench, 2 mm	1
7	151.8134	T-handle ball ended hexagon key wrench, 5 mm	1
8	151.8131	T-handle ball ended hexagon key wrench, 2,5 mm	1
9	151.8135	T-handle ball ended hexagon key wrench, 6 mm	1
10	151.8132	T-handle ball ended hexagon key wrench, 3 mm	1
11	151.8136	T-handle ball ended hexagon key wrench, 7 mm	1
12	151.8133	T-handle ball ended hexagon key wrench, 4 mm	1
13	151.8137	T-handle ball ended hexagon key wrench, 8 mm	1
14	159.1127	ERGOTORQUEplus Socket screwdriver, 7 mm	1
15	159.1201	ERGOTORQUEplus Socket screwdriver, 4 mm	1
16	159.1202	ERGOTORQUEplus Socket screwdriver, 5 mm	9
17	159.1203	ERGOTORQUEplus Socket screwdriver, 5,5 mm	9
18	159.1204	ERGOTORQUEplus Socket screwdriver, 6 mm	1
19	159.1206	ERGOTORQUEplus Socket screwdriver, 8 mm	1
20	159.1207	ERGOTORQUEplus Socket screwdriver, 9 mm	1
21	159.1208	ERGOTORQUEplus Socket screwdriver, 10 mm	1
22	159.1209	ERGOTORQUEplus Socket screwdriver, 11 mm	1
23	159.1210	ERGOTORQUEplus Socket screwdriver, 12 mm	1
24	159.1211	ERGOTORQUEplus Socket screwdriver, 13 mm	1
25	151.4530	Ball ended Torx key wrench set, extra long and bent 108°, 9 pcs	1
26	151.4420	Ball ended hexagon key wrench set, extra long, 9 pcs	1

813.0024

L T-handle angle wrench and screwdriver set

419,- EUR

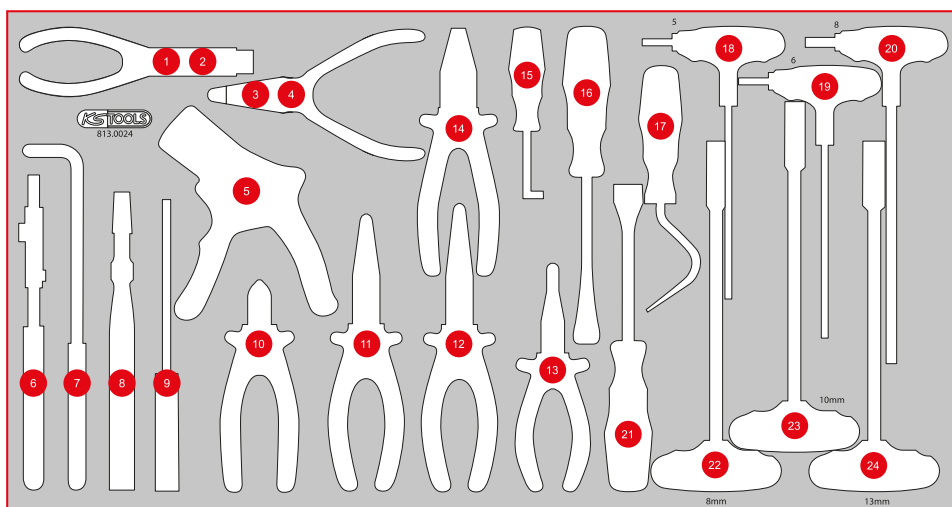

Pos.	Code	Description	pcs
1	500.1035	Circlip pliers for internal circlips, 160 mm	1
2	500.1032	Circlip pliers for internal circlips, angled, 160 mm	1
3	500.1029	Circlip pliers for external circlips, 160 mm	1
4	500.1026	Circlip pliers for external circlips, angled, 160 mm	1
5	115.1239	Self regulating wire stripper, 0,2-6 mm	1
6	115.2010	Water pump pliers, 240 mm	1
7	500.7053	Telephone pliers 90° curved, extra long, 270mm	1
8	115.1033	Self grip wrench, 220 mm	1
9	115.1231	Multifunction pliers for insulated and non insulated cable terminals, 220 mm	1
10	115.1012	ERGOTORQUE diagonal side cutter, 160 mm	1
11	115.1019	ERGOTORQUE bent nose pliers serrated, 210 mm	1
12	115.1024	ERGOTORQUE long nose pliers serrated cutter, 200 mm	1
13	115.1016	ERGOTORQUE flat pliers serrated, 160mm	1
14	115.1021	ERGOTORQUE combination pliers, 180 mm	1
15	550.1048	Hook, 90° offset	1
16	140.2373	Clip remover short, length 245 mm, Opening 10 mm	1
17	550.1073	Hook, large, sickle	1
18	151.8134	T-handle ball ended hexagon key wrench, 5 mm	1
19	151.8135	T-handle ball ended hexagon key wrench, 6 mm	1
20	151.8137	T-handle ball ended hexagon key wrench, 8 mm	1
21	140.2616	Clip remover, short 7,5 mm	1
22	158.5008	T-handle socket screwdriver, long, 8 mm	1
23	158.5010	T-handle socket screwdriver, long, 10 mm	1
24	158.5013	T-handle socket screwdriver, long, 13 mm	1

P 10

P 15

P 20

P 25

P 30

P 35

P 40

P 45

L M

L

S XL

Individual parts

Accessories

813.0028

L T-handle angle spanner and file set

229, ^{EUR}—



755 x 398

P25

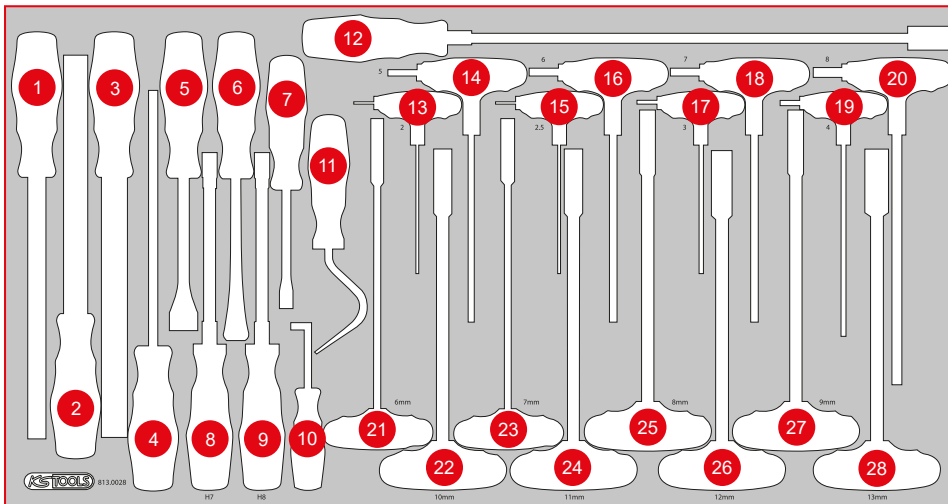

Pos.	Code	Description	pcs
1	157.0405	Tri-bastard file, form C, cut 2, 200 mm	1
2	157.0105	Halfround file, form E, cut 2, 20 mm	1
3	157.0005	Flat file, form B, cut 2, 200 mm	1
4	157.0205	Round file, form F, cut 2, 200 mm	1
5	140.2615	Clip remover, short 9 mm	1
6	140.2616	Clip remover, short 7,5 mm	1
7	140.2371	Clip remover short, Length 245 mm, Opening 4 mm	1
8	159.1127	ERGOTORQUEplus Socket screwdriver, 7 mm	1
9	159.2128	ERGOTORQUEplus Socket screwdriver, 8 mm	1
10	550.1048	Hook, 90° offset	1
11	550.1073	Hook, large, sickle	1
12	550.1025	Flexible magnet lifter, 510mm, Øhead=15mm	1
13	151.8130	T-handle ball ended hexagon key wrench, 2 mm	1
14	151.8134	T-handle ball ended hexagon key wrench, 5 mm	1
15	151.8131	T-handle ball ended hexagon key wrench, 2,5 mm	1
16	151.8135	T-handle ball ended hexagon key wrench, 6 mm	1
17	151.8132	T-handle ball ended hexagon key wrench, 3 mm	1
18	151.8136	T-handle ball ended hexagon key wrench, 7 mm	1
19	151.8133	T-handle ball ended hexagon key wrench, 4 mm	1
20	151.8137	T-handle ball ended hexagon key wrench, 8 mm	1
21	158.5006	T-handle socket screwdriver, long, 6 mm	1
22	158.5010	T-handle socket screwdriver, long, 10 mm	1
23	158.5007	T-handle socket screwdriver, long, 7 mm	1
24	158.5011	T-handle socket screwdriver, long, 11 mm	1
25	158.5008	T-handle socket screwdriver, long, 8 mm	1
26	158.5012	T-handle socket screwdriver, long, 12 mm	1
27	158.5009	T-handle socket screwdriver, long, 9 mm	1
28	158.5013	T-handle socket screwdriver, long, 13 mm	1



P 10

P 15

P 20

P 25

P 30

P 35

P 40

P 45

L M

S XL

Individual parts

Accessories

813.0053

L Screw spanner set

509, — ^{EUR}



IPCS
53

755 x 398
P25

Pos.	Code	Description	pcs	Pos.	Code	Description	pcs	Pos.	Code	Description	pcs
1	517.0606	Combination spanners, offset, 6 mm	1	13	517.0618	Combination spanners, offset, 18 mm	1	25	517.0630	Combination spanners, offset, 30 mm	1
2	517.0607	Combination spanners, offset, 7 mm	1	14	517.0619	Combination spanners, offset, 19 mm	1	26	517.0632	Combination spanners, offset, 32 mm	1
3	517.0608	Combination spanners, offset, 8 mm	1	15	517.0620	Combination spanners, offset, 20 mm	1	27	503.4608	GEARplus reversing combination ratcheting spanner, 8 mm	1
4	517.0609	Combination spanners, offset, 9 mm	1	16	517.0621	Combination spanners, offset, 21 mm	1	28	503.4609	GEARplus reversing combination ratcheting spanner, 9 mm	1
5	517.0610	Combination spanners, offset, 10 mm	1	17	517.0622	Combination spanners, offset, 22 mm	1	29	503.4610	GEARplus reversing combination ratcheting spanner, 10 mm	1
6	517.0611	Combination spanners, offset, 11 mm	1	18	517.0623	Combination spanners, offset, 23 mm	1	30	503.4611	GEARplus reversing combination ratcheting spanner, 11 mm	1
7	517.0612	Combination spanners, offset, 12 mm	1	19	517.0624	Combination spanners, offset, 24 mm	1	31	503.4612	GEARplus reversing combination ratcheting spanner, 12 mm	1
8	517.0613	Combination spanners, offset, 13 mm	1	20	517.0625	Combination spanners, offset, 25 mm	1	32	503.4613	GEARplus reversing combination ratcheting spanner, 13 mm	1
9	517.0614	Combination spanners, offset, 14 mm	1	21	517.0626	Combination spanners, offset, 26 mm	1				
10	517.0615	Combination spanners, offset, 15 mm	1	22	517.0627	Combination spanners, offset, 27 mm	1				
11	517.0616	Combination spanners, offset, 16 mm	1	23	517.0628	Combination spanners, offset, 28 mm	1				
12	517.0617	Combination spanners, offset, 17 mm	1	24	517.0629	Combination spanners, offset, 29 mm	1				

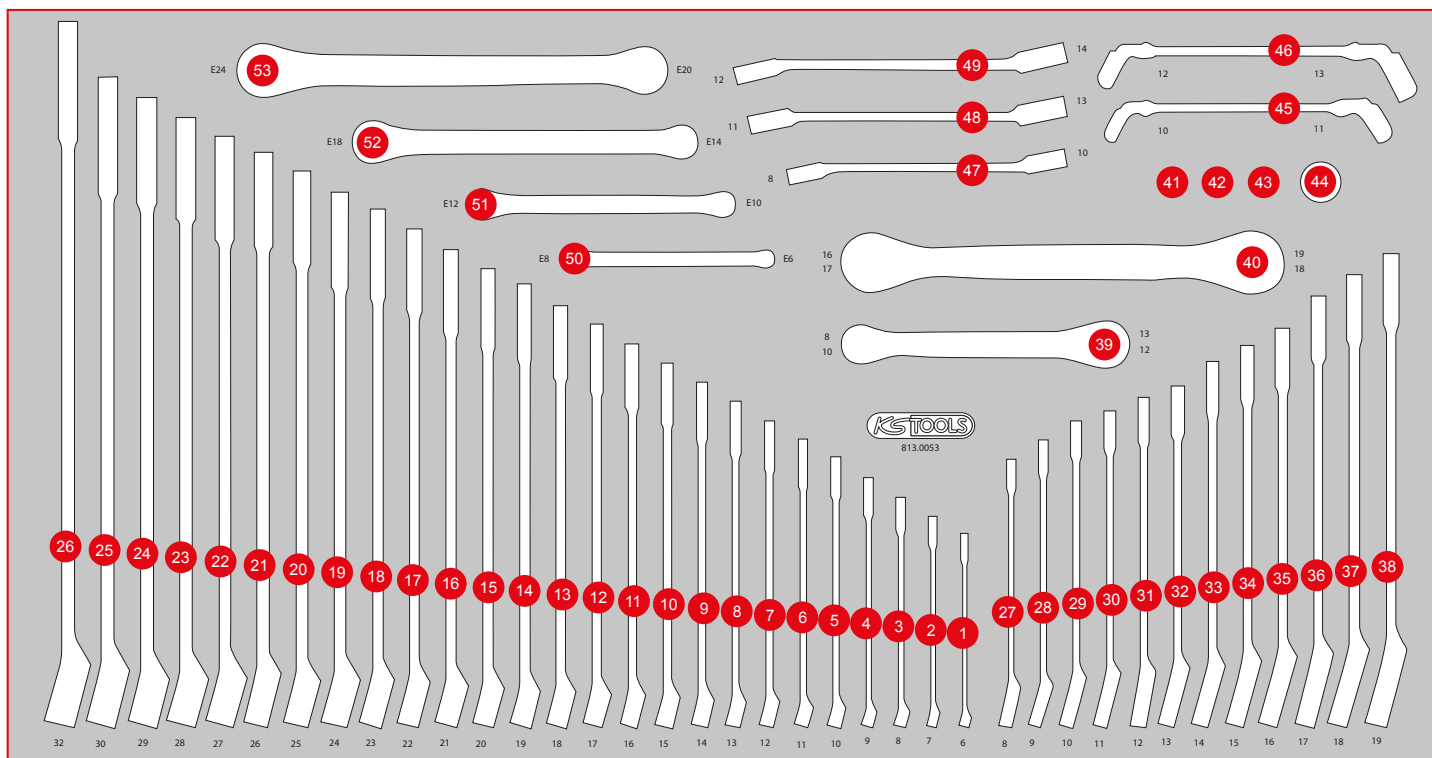

Pos.	Code	Description	pcs	Pos.	Code	Description	pcs	Pos.	Code	Description	pcs
33	503.4614	GEARplus reversing combination ratcheting spanner, 14 mm	1	40	503.4546	4 in 1 GEARplus reversing double ratchet ring spanner, 16x17x18x19mm	1	50	911.0371	Double ring spanner for Torx E profile, E6 x E8	1
34	503.4615	GEARplus reversing combination ratcheting spanner, 15 mm	1	41	503.4290	GEARplus bit adaptor, 1/4" x 10mm	1	51	911.0373	Double ring spanner for Torx E profile, E10 x E12	1
35	503.4616	GEARplus reversing combination ratcheting spanner, 16 mm	1	42	503.4296	GEARplus socket adaptor, 1/4" x 10 mm	1	52	911.0374	Double ring spanner for Torx E profile, E14 x E18	1
36	503.4617	GEARplus reversing combination ratcheting spanner, 17 mm	1	43	503.4297	GEARplus socket adaptor, 3/8" x 13 mm	1	53	911.0376	Double ring spanner for Torx E profile, E20 x E24	1
37	503.4618	GEARplus reversing combination ratcheting spanner, 18 mm	1	44	503.4298	GEARplus socket adaptor, 1/2" x 19 mm	1				
38	503.4619	GEARplus reversing combination ratcheting spanner, 19 mm	1	45	518.0528	Open double ring spanner, with double joint, 10 x 11	1				
39	503.4656	4 in 1 GEARplus reversing double ratchet ring spanner, 8x10+12x13mm	1	46	518.0529	Open double ring spanner, with double joint, 12 x 13	1				
				47	517.0252	Open double ring spanner, offset, 8 x 10 mm	1				
				48	517.9244	Open double ring spanner, offset, 11 x 13 mm	1				
				49	517.0258	Open double ring spanner, offset, 12 x 14 mm	1				

P 10
P 15
P 20
P 25
P 30
P 35
P 40
P 45
S
XL
L
M
Individual parts
Accessories

813.0054

L Screw spanner set

319,^{EUR}—



IPCS
54

755 x 398
P25

Pos.	Code	Description	pcs
1	518.0852	CHROMEplus Starter and block spanner, 10 x 12 mm	1
2	518.0859	CHROMEplus Starter and block spanner, 19 x 22 mm	1
3	518.0857	CHROMEplus Starter and block spanner, 16 x 18 mm	1
4	518.0856	CHROMEplus Starter and block spanner, 14 x 17 mm	1
5	518.0853	CHROMEplus Starter and block spanner, 11 x 13 mm	1
6	517.0718	Double open ended spanners, 30 x 32 mm	1
7	517.0737	Double open ended spanners, 25 x 28 mm	1
8	517.0716	Double open ended spanners, 24 x 27 mm	1
9	517.0715	Double open ended spanners, 21 x 23 mm	1
10	517.0714	Double open ended spanners, 20 x 22 mm	1

Pos.	Code	Description	pcs
11	517.0712	Double open ended spanners, 18 x 19 mm	1
12	517.0710	Double open ended spanners, 16 x 17 mm	1
13	517.0709	Double open ended spanners, 14 x 15 mm	1
14	517.0707	Double open ended spanners, 12 x 13 mm	1
15	517.0704	Double open ended spanners, 10 x 11 mm	1
16	517.0702	Double open ended spanners, 8 x 9 mm	1
17	517.0701	Double open ended spanners, 6 x 7 mm	1
18	920.0406	ULTIMATEplus Double ring ended spanner, 6 x 7 mm	1
19	920.0408	ULTIMATEplus Double ring ended spanner, 8 x 9 mm	1
20	920.0410	ULTIMATEplus Double ring ended spanner, 10 x 11 mm	1
21	920.0412	ULTIMATEplus Double ring ended spanner, 12 x 13 mm	1

Pos.	Code	Description	pcs
22	920.0414	ULTIMATEplus Double ring ended spanner, 14 x 15 mm	1
23	920.0416	ULTIMATEplus Double ring ended spanner, 16 x 17 mm	1
24	920.0418	ULTIMATEplus Double ring ended spanner, 18 x 19 mm	1
25	517.0252	Open double ring spanner, offset, 8 x 10 mm	1
26	517.9244	Open double ring spanner, offset, 11 x 13 mm	1
27	517.0258	Open double ring spanner, offset, 12 x 14 mm	1
28	517.0263	Open double ring spanner, offset, 16 x 18 mm	1
29	517.0264	Open double ring spanner, offset, 17 x 19 mm	1
30	517.0266	Open double ring spanner, offset, 19 x 22 mm	1
31	517.0268	Open double ring spanner, offset, 24 x 27 mm	1
32	517.0269	Open double ring spanner, offset, 30 x 32 mm	1

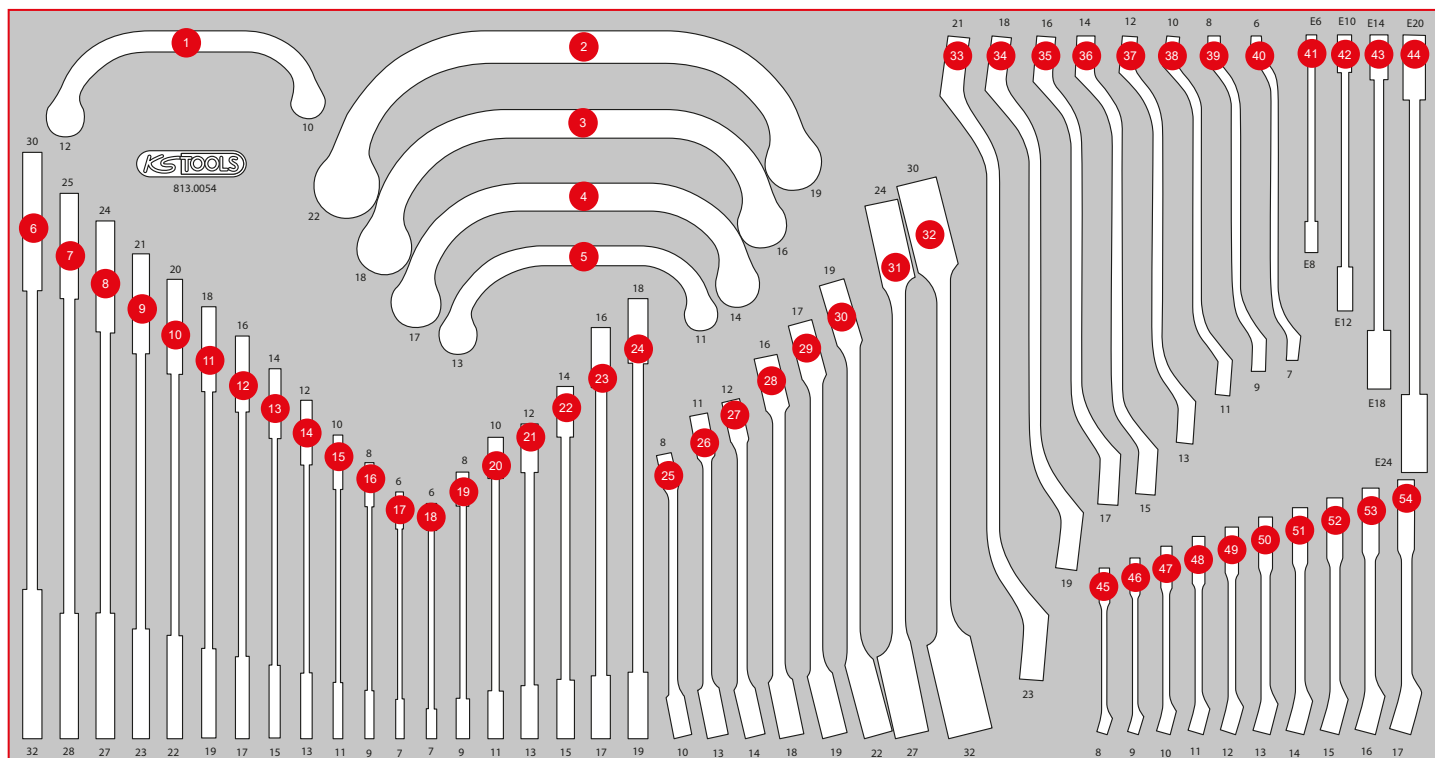

Pos.	Code	Description	pcs	Pos.	Code	Description	pcs	Pos.	Code	Description	pcs
33	517.0815	Double ring spanner, offset, 21 x 23 mm	1	44	911.0376	Double ring spanner for Torx E profile, E20 x E24	1	51	518.0014	CHROMEplus Combination spanner, stubby, 14 mm	1
34	517.0812	Double ring spanner, offset, 18 x 19 mm	1	45	518.0007	CHROMEplus Combination spanner, stubby, 8 mm	1	52	518.0015	CHROMEplus Combination spanner, stubby, 15 mm	1
35	517.0810	Double ring spanner, offset, 16 x 17 mm	1	46	518.0008	CHROMEplus Combination spanner, stubby, 9 mm	1	53	518.0016	CHROMEplus Combination spanner, stubby, 16 mm	1
36	517.0809	Double ring spanner, offset, 14 x 15 mm	1	47	518.0010	CHROMEplus Combination spanner, stubby, 10 mm	1	54	518.0017	CHROMEplus Combination spanner, stubby, 17 mm	1
37	517.0807	Double ring spanner, offset, 12 x 13 mm	1	48	518.0011	CHROMEplus Combination spanner, stubby, 11 mm	1				
38	517.0804	Double ring spanner, offset, 10 x 11 mm	1	49	518.0012	CHROMEplus Combination spanner, stubby, 12 mm	1				
39	517.0802	Double ring spanner, offset, 8 x 9 mm	1	50	518.0013	CHROMEplus Combination spanner, stubby, 13 mm	1				
40	517.0801	Double ring spanner, offset, 6 x 7 mm	1								
41	911.0371	Double ring spanner for Torx E profile, E6 x E8	1								
42	911.0373	Double ring spanner for Torx E profile, E10 x E12	1								
43	911.0374	Double ring spanner for Torx E profile, E14 x E18	1								

P 10
P 15
P 20
P 25
P 30
P 35
P 40
P 45
Individual parts
Accessories

813.0055

L Screw spanner set

489, —^{EUR}



55



755 x 398



P25

Pos.	Code	Description	pcs
1	517.0606	Combination spanners, offset, 6 mm	1
2	517.0607	Combination spanners, offset, 7 mm	1
3	517.0608	Combination spanners, offset, 8 mm	1
4	517.0609	Combination spanners, offset, 9 mm	1
5	517.0610	Combination spanners, offset, 10 mm	1
6	517.0611	Combination spanners, offset, 11 mm	1
7	517.0612	Combination spanners, offset, 12 mm	1
8	517.0613	Combination spanners, offset, 13 mm	1
9	517.0614	Combination spanners, offset, 14 mm	1
10	517.0615	Combination spanners, offset, 15 mm	1
11	517.0616	Combination spanners, offset, 16 mm	1
12	517.0617	Combination spanners, offset, 17 mm	1

Pos.	Code	Description	pcs
13	517.0618	Combination spanners, offset, 18 mm	1
14	517.0619	Combination spanners, offset, 19 mm	1
15	517.0620	Combination spanners, offset, 20 mm	1
16	517.0621	Combination spanners, offset, 21 mm	1
17	517.0622	Combination spanners, offset, 22 mm	1
18	517.0624	Combination spanners, offset, 24 mm	1
19	517.0627	Combination spanners, offset, 27 mm	1
20	517.0630	Combination spanners, offset, 30 mm	1
21	517.0632	Combination spanners, offset, 32 mm	1
22	911.0371	Double ring spanner for Torx E profile, E6 x E8	1
23	911.0372	Double ring spanner for Torx E profile, E7 x E11	1
24	911.0373	Double ring spanner for Torx E profile, E10 x E12	1

Pos.	Code	Description	pcs
25	911.0374	Double ring spanner for Torx E profile, E14 x E18	1
26	911.0375	Double ring spanner for Torx E profile, E16 x E22	1
27	911.0376	Double ring spanner for Torx E profile, E20 x E24	1
28	503.4608	GEARplus reversing combination ratcheting spanner, 8 mm	1
29	503.4609	GEARplus reversing combination ratcheting spanner, 9 mm	1
30	503.4610	GEARplus reversing combination ratcheting spanner, 10 mm	1
31	503.4611	GEARplus reversing combination ratcheting spanner, 11 mm	1

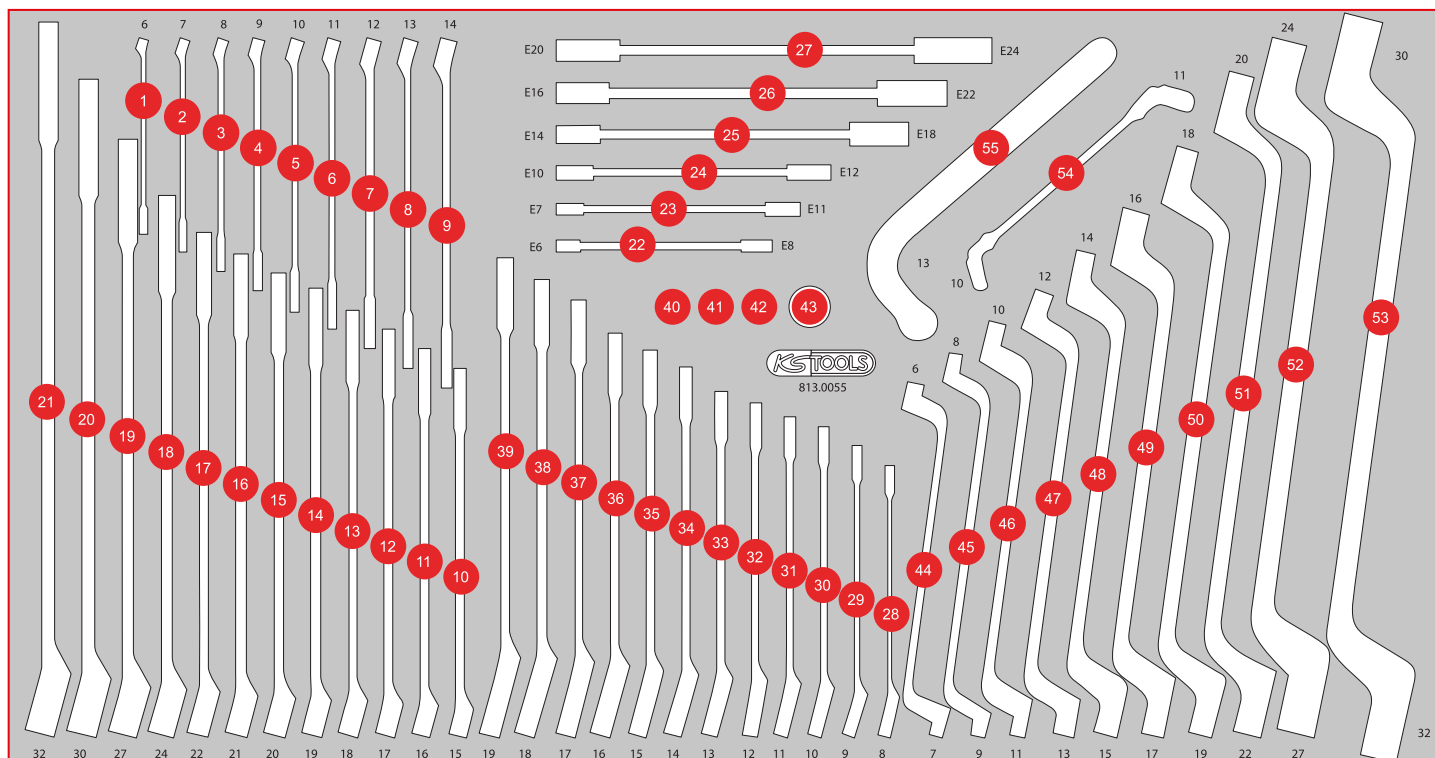

Pos.	Code	Description	pcs	Pos.	Code	Description	pcs	Pos.	Code	Description	pcs
32	503.4612	GEARplus reversing combination ratcheting spanner, 12 mm	1	38	503.4618	GEARplus reversing combination ratcheting spanner, 18 mm	1	47	517.0807	Double ring spanner, offset, 12 x 13 mm	1
33	503.4613	GEARplus reversing combination ratcheting spanner, 13 mm	1	39	503.4619	GEARplus reversing combination ratcheting spanner, 19 mm	1	48	517.0809	Double ring spanner, offset, 14 x 15 mm	1
34	503.4614	GEARplus reversing combination ratcheting spanner, 14 mm	1	40	503.4290	GEARplus bit adaptor, 1/4" x 10 mm	1	49	517.0810	Double ring spanner, offset, 16 x 17 mm	1
35	503.4615	GEARplus reversing combination ratcheting spanner, 15 mm	1	41	503.4296	GEARplus socket adaptor, 1/4" x 10 mm	1	50	517.0812	Double ring spanner, offset, 18 x 19 mm	1
36	503.4616	GEARplus reversing combination ratcheting spanner, 16 mm	1	42	503.4297	GEARplus socket adaptor, 3/8" x 13 mm	1	51	517.0813	Double ring spanner, offset, 20 x 22 mm	1
37	503.4617	GEARplus reversing combination ratcheting spanner, 17 mm	1	43	503.4298	GEARplus socket adaptor, 1/2" x 19 mm	1	52	517.0816	Double ring spanner, offset, 24 x 27 mm	1
				44	517.0801	Double ring spanner, offset, 6 x 7 mm	1	53	517.0818	Double ring spanner, offset, 30 x 32 mm	1
				45	517.0802	Double ring spanner, offset, 8 x 9 mm	1	54	518.0528	Open double ring spanner, with double joint, 10 x 11	1
				46	517.0804	Double ring spanner, offset, 10 x 11 mm	1	55	152.1396	Injector pump wrench, 13 mm	1

P 10
P 15
P 20
P 25
P 30
P 35
P 40
P 45
L M
S XL
Accessories Individual parts

813.0057

L Screw spanner set

499,^{EUR}—

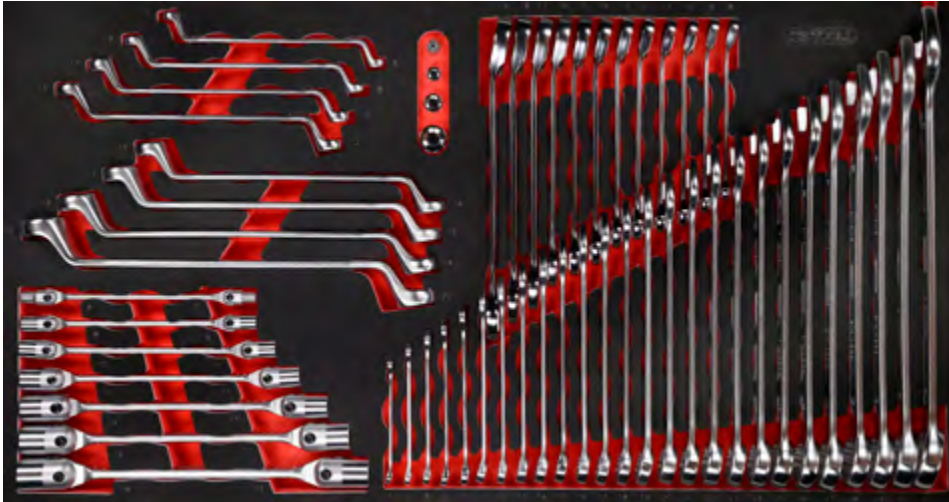

Pos.	Code	Description	pcs	Pos.	Code	Description	pcs	Pos.	Code	Description	pcs
1	517.0606	Combination spanners, offset, 6 mm	1	13	517.0618	Combination spanners, offset, 18 mm	1	25	517.0630	Combination spanners, offset, 30 mm	1
2	517.0607	Combination spanners, offset, 7 mm	1	14	517.0619	Combination spanners, offset, 19 mm	1	26	517.0632	Combination spanners, offset, 32 mm	1
3	517.0608	Combination spanners, offset, 8 mm	1	15	517.0620	Combination spanners, offset, 20 mm	1	27	503.4608	GEARplus reversing combination ratcheting spanner, 8 mm	1
4	517.0609	Combination spanners, offset, 9 mm	1	16	517.0621	Combination spanners, offset, 21 mm	1	28	503.4609	GEARplus reversing combination ratcheting spanner, 9 mm	1
5	517.0610	Combination spanners, offset, 10 mm	1	17	517.0622	Combination spanners, offset, 22 mm	1	29	503.4610	GEARplus reversing combination ratcheting spanner, 10 mm	1
6	517.0611	Combination spanners, offset, 11 mm	1	18	517.0623	Combination spanners, offset, 23 mm	1	30	503.4611	GEARplus reversing combination ratcheting spanner, 11 mm	1
7	517.0612	Combination spanners, offset, 12 mm	1	19	517.0624	Combination spanners, offset, 24 mm	1	31	503.4612	GEARplus reversing combination ratcheting spanner, 12 mm	1
8	517.0613	Combination spanners, offset, 13 mm	1	20	517.0625	Combination spanners, offset, 25 mm	1	32	503.4613	GEARplus reversing combination ratcheting spanner, 13 mm	1
9	517.0614	Combination spanners, offset, 14 mm	1	21	517.0626	Combination spanners, offset, 26 mm	1				
10	517.0615	Combination spanners, offset, 15 mm	1	22	517.0627	Combination spanners, offset, 27 mm	1				
11	517.0616	Combination spanners, offset, 16 mm	1	23	517.0628	Combination spanners, offset, 28 mm	1				
12	517.0617	Combination spanners, offset, 17 mm	1	24	517.0629	Combination spanners, offset, 29 mm	1				

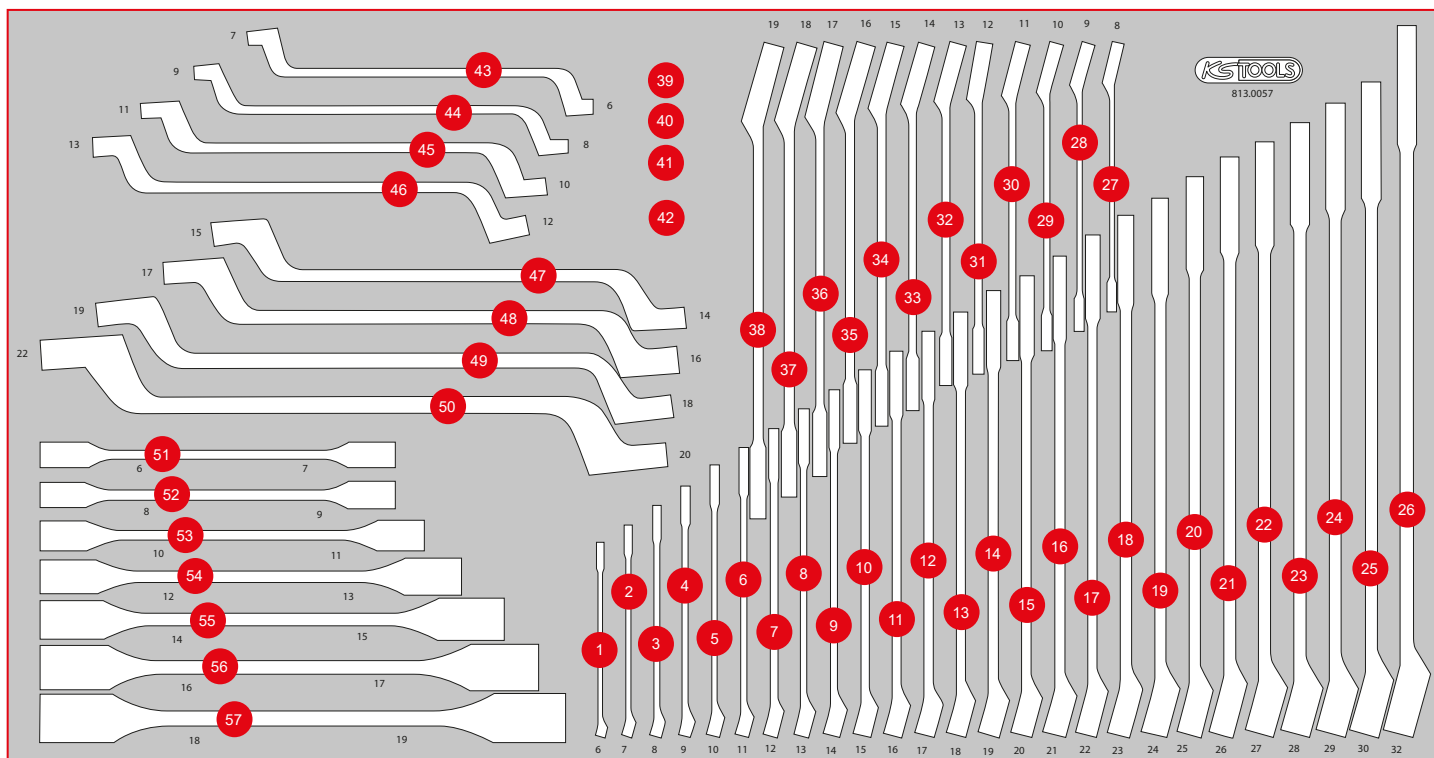

Pos.	Code	Description	pcs	Pos.	Code	Description	pcs	Pos.	Code	Description	pcs
33	503.4614	GEARplus reversing combination ratcheting spanner, 14 mm	1	41	503.4297	GEARplus socket adaptor, 3/8" x 13 mm	1	53	517.0302	Double revolving head spanner, 10 x 11 mm	1
34	503.4615	GEARplus reversing combination ratcheting spanner, 15 mm	1	42	503.4298	GEARplus socket adaptor, 1/2" x 19 mm	1	54	517.0303	Double revolving head spanner, 12 x 13 mm	1
35	503.4616	GEARplus reversing combination ratcheting spanner, 16 mm	1	43	517.0801	Double ring spanner, offset, 6 x 7 mm	1	55	517.0304	Double revolving head spanner, 14 x 15 mm	1
36	503.4617	GEARplus reversing combination ratcheting spanner, 17 mm	1	44	517.0802	Double ring spanner, offset, 8 x 9 mm	1	56	517.0305	Double revolving head spanner, 16 x 17 mm	1
37	503.4618	GEARplus reversing combination ratcheting spanner, 18 mm	1	45	517.0804	Double ring spanner, offset, 10 x 11 mm	1	57	517.0306	Double revolving head spanner, 18 x 19 mm	1
38	503.4619	GEARplus reversing combination ratcheting spanner, 19 mm	1	46	517.0807	Double ring spanner, offset, 12 x 13 mm	1				
39	503.4290	GEARplus bit adaptor, 1/4" x 10 mm	1	47	517.0809	Double ring spanner, offset, 14 x 15 mm	1				
40	503.4296	GEARplus socket adaptor, 1/4" x 10 mm	1	48	517.0810	Double ring spanner, offset, 16 x 17 mm	1				
				49	517.0812	Double ring spanner, offset, 18 x 19 mm	1				
				50	517.0813	Double ring spanner, offset, 20 x 22 mm	1				
				51	517.0300	Double revolving head spanner, 6 x 7 mm	1				
				52	517.0301	Double revolving head spanner, 8 x 9 mm	1				

P 10
P 15
P 20
P 25
P 30
P 35
P 40
P 45
S XL L M
Individual parts
Accessories

813.0068

L Screw spanner set

449,^{EUR}-



IPCS
68

755 x 398



P25

Pos.	Code	Description	pcs	Pos.	Code	Description	pcs	Pos.	Code	Description	pcs
1	517.0718	Double open ended spanners, 30 x 32 mm	1	13	518.0856	CHROMEplus Starter and block spanner, 14 x 17 mm	1	20	518.0010	CHROMEplus Combination spanner, stubby, 10 mm	1
2	517.0737	Double open ended spanners, 25 x 28 mm	1	14	518.0853	CHROMEplus Starter and block spanner, 11 x 13 mm	1	21	518.0011	CHROMEplus Combination spanner, stubby, 11 mm	1
3	517.0716	Double open ended spanners, 24 x 27 mm	1	15	518.0852	CHROMEplus Starter and block spanner, 10 x 12 mm	1	22	518.0012	CHROMEplus Combination spanner, stubby, 12 mm	1
4	517.0715	Double open ended spanners, 21 x 23 mm	1	16	151.4530	Ball ended Torx key wrench set, extra long and bent 108°, 9 pcs	9	23	518.0013	CHROMEplus Combination spanner, stubby, 13 mm	1
5	517.0714	Double open ended spanners, 20 x 22 mm	1	17	151.4420	Ball ended hexagon key wrench set, extra long, 9 pcs	9	24	518.0014	CHROMEplus Combination spanner, stubby, 14 mm	1
6	517.0712	Double open ended spanners, 18 x 19 mm	1	18	518.0007	CHROMEplus Combination spanner, stubby, 8 mm	1	25	518.0015	CHROMEplus Combination spanner, stubby, 15 mm	1
7	517.0710	Double open ended spanners, 16 x 17 mm	1	19	518.0008	CHROMEplus Combination spanner, stubby, 9 mm	1	26	518.0016	CHROMEplus Combination spanner, stubby, 16 mm	1
8	517.0709	Double open ended spanners, 14 x 15 mm	1								
9	517.0707	Double open ended spanners, 12 x 13 mm	1								
10	517.0704	Double open ended spanners, 10 x 11 mm	1								
11	517.0702	Double open ended spanners, 8 x 9 mm	1								
12	517.0701	Double open ended spanners, 6 x 7 mm	1								

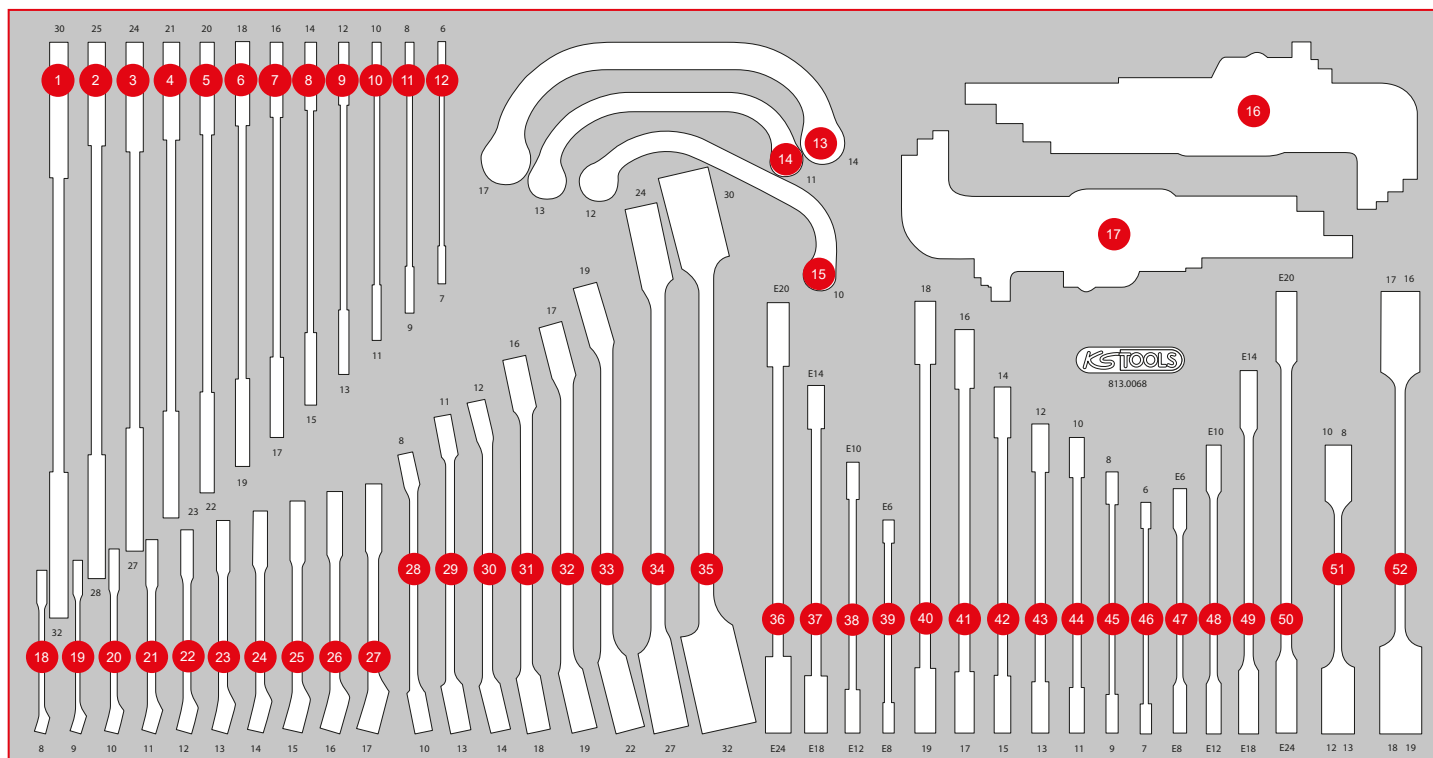

Pos.	Code	Description	pcs	Pos.	Code	Description	pcs	Pos.	Code	Description	pcs
27	518.0017	CHROMEplus Combination spanner, stubby, 17 mm	1	38	911.0373	Double ring spanner for Torx E profile, E10 x E12	1	46	920.0406	ULTIMATEplus Double ring ended spanner, 6 x 7 mm	1
28	517.0252	Open double ring spanner, offset, 8 x 10 mm	1	39	911.0371	Double ring spanner for Torx E profile, E6 x E8	1	47	503.4351	GEARplus Double ring ratchet spanner, E6 x E8	1
29	517.9244	Open double ring spanner, offset, 11 x 13 mm	1	40	920.0418	ULTIMATEplus Double ring ended spanner, 18 x 19 mm	1	48	503.4353	GEARplus Double ring ratchet spanner, E10 x E12	1
30	517.0258	Open double ring spanner, offset, 12 x 14 mm	1	41	920.0416	ULTIMATEplus Double ring ended spanner, 16 x 17 mm	1	49	503.4355	GEARplus Double ring ratchet spanner, E14 x E18	1
31	517.0263	Open double ring spanner, offset, 16 x 18 mm	1	42	920.0414	ULTIMATEplus Double ring ended spanner, 14 x 15 mm	1	50	503.4357	GEARplus Double ring ratchet spanner, E20 x E24	1
32	517.0264	Open double ring spanner, offset, 17 x 19 mm	1	43	920.0412	ULTIMATEplus Double ring ended spanner, 12 x 13 mm	1	51	503.4656	4 in 1 GEARplus reversing double ratchet ring spanner, 8 x 10 x 12 x 13 mm	1
33	517.0266	Open double ring spanner, offset, 19 x 22 mm	1	44	920.0410	ULTIMATEplus Double ring ended spanner, 10 x 11 mm	1	52	503.4546	4 in 1 GEARplus reversing double ratchet ring spanner, 16 x 17 x 18 x 19 mm	1
34	517.0268	Open double ring spanner, offset, 24 x 27 mm	1	45	920.0408	ULTIMATEplus Double ring ended spanner, 8 x 9 mm	1				
35	517.0269	Open double ring spanner, offset, 30 x 32 mm	1								
36	911.0376	Double ring spanner for Torx E profile, E20 x E24	1								
37	911.0374	Double ring spanner for Torx E profile, E14 x E18	1								

P 10
P 15
P 20
P 25
P 30
P 35
P 40
P 45
S
XL
L
M
Individual parts
Accessories



813.1036

L Hammer, chisel and measuring tool set

329,- EUR

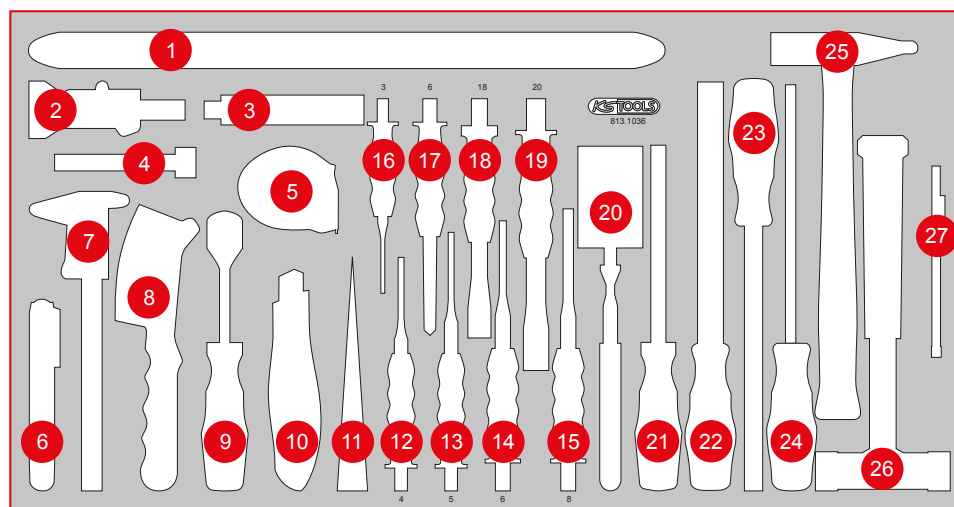

Pos.	Code	Description	pcs
1	911.8199	Tyre iron for installing and removing tyres with replaceable plastic coating, 500mm	1
2	300.0550	Digital depth gauge 0-25 mm, 125 mm	1
3	907.2206	Trapezoid blades, pack of 10	10
4	300.0600	Feeler gauge, 20 Blades, 0,05 - 1 mm	1
5	300.0114	Tape measure with locking device and belt clip, black red, 5 m, 19 mm	1
6	150.2199	Brake fluid tester	1
7	300.0510	Pocket vernier calliper 0-150 mm, 235 mm	1
8	201.2320	Steel wire brake saddle wire brush 2 rowed, straight	1
9	907.2222	Gasket scraper, 25 x 200 mm	1
10	907.2140	Professional safety universal knife, 145 mm	1
11	911.8138	Trim plastic wedge, 195 mm x B = 30 mm	1
12	156.0232	Pin punch, Ø 4 mm, cylindrical shaft	1
13	156.0233	Pin punch, Ø 5 mm, cylindrical shaft	1
14	156.0234	Pin punch, Ø 6 mm, cylindrical shaft	1
15	156.0235	Pin punch, Ø 8 mm, cylindrical shaft	1
16	156.0231	Pin punch, Ø 3 mm, cylindrical shaft	1
17	156.0243	Centre punch, octagon 10 mm	1
18	156.0241	Flat chisel, octagon, 20 mm	1
19	156.0254	Flat chisel, octagon, 18 mm	1
20	550.1136	Flexible inspection mirror with lighting	1
21	157.0960	Brake saddle file, extra narrow, 270 mm	1
22	157.0105	Halfround file, form E, cut 2, 20 mm	1
23	157.0405	Tri-bastard file, form C, cut 2, 200 mm	1
24	157.0205	Round file, form F, cut 2, 200 mm	1
25	142.1402	Fitters hammer, fibreglas handle, 400 g	1
26	140.5271	Recoil free soft faced hammer, 480 g	1
27	550.1001	2 in 1 Telescopic solenoid holder with washer jet cleaning and setting tool, 150 - 675 mm	1

P 10
P 15
P 20
P 25
P 30
P 35
P 40
P 45
S
XL
L
M
Individual parts
Accessories

813.0040

L Hammer, chisel and impact socket set

299, ^{EUR}—





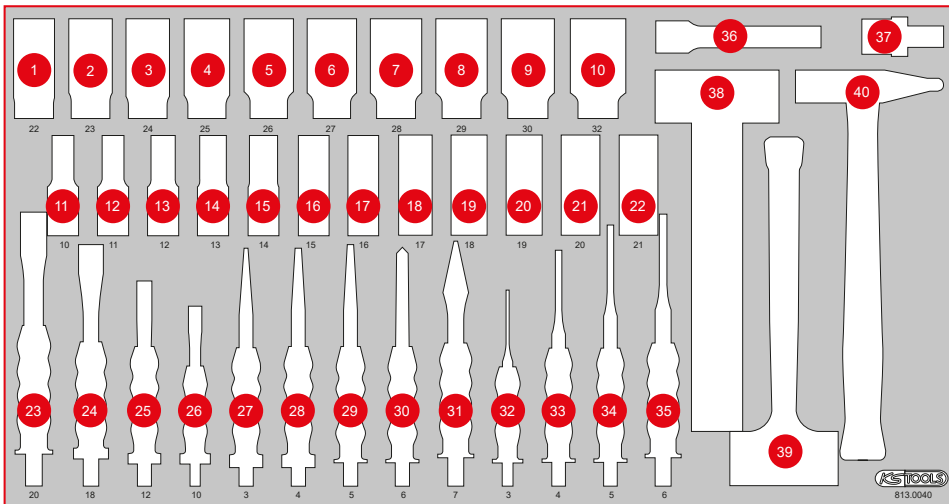

Pos.	Code	Description	pcs
1	515.1122	1/2" Hexagon impact socket, deep, 22 mm	1
2	515.1123	1/2" Hexagon impact socket, deep, 23 mm	1
3	515.1124	1/2" Hexagon impact socket, deep, 24 mm	1
4	515.1125	1/2" Hexagon impact socket, deep, 25 mm	1
5	515.1126	1/2" Hexagon impact socket, deep, 26 mm	1
6	515.1127	1/2" Hexagon impact socket, deep, 27 mm	1
7	515.1128	1/2" Hexagon impact socket, deep, 28 mm	1
8	515.1129	1/2" Hexagon impact socket, deep, 29 mm	1
9	515.1130	1/2" Hexagon impact socket, deep, 30 mm	1
10	515.1132	1/2" Hexagon impact socket, deep, 32 mm	1
11	515.1110	1/2" Hexagon impact socket, deep, 10 mm	1
12	515.1111	1/2" Hexagon impact socket, deep, 11 mm	1
13	515.1112	1/2" Hexagon impact socket, deep, 12 mm	1
14	515.1113	1/2" Hexagon impact socket, deep, 13 mm	1
15	515.1114	1/2" Hexagon impact socket, deep, 14 mm	1
16	515.1115	1/2" Hexagon impact socket, deep, 15 mm	1
17	515.1116	1/2" Hexagon impact socket, deep, 16 mm	1
18	515.1117	1/2" Hexagon impact socket, deep, 17 mm	1
19	515.1118	1/2" Hexagon impact socket, deep, 18 mm	1
20	515.1119	1/2" Hexagon impact socket, deep, 19 mm	1
21	515.1120	1/2" Hexagon impact socket, deep, 20 mm	1
22	515.1121	1/2" Hexagon impact socket, deep, 21 mm	1
23	156.0241	Flat chisel, octagon, 20 mm	1
24	156.0254	Flat chisel, octagon, 18 mm	1
25	156.0252	Flat chisel, octagon, 12 mm	1
26	156.0251	Flat chisel, octagon, 10 mm	1
27	156.0237	Punch, Ø 3 mm, conical	1
28	156.0238	Punch, Ø 4 mm, conical	1
29	156.0244	Punch, Ø 5 mm, conical	1
30	156.0243	Centre punch, octagon 10 mm	1
31	156.0242	Cross chisel, octagon, 7 mm	1
32	156.0231	Pin punch, Ø 3 mm, cylindrical shaft	1
33	156.0232	Pin punch, Ø 4 mm, cylindrical shaft	1
34	156.0233	Pin punch, Ø 5 mm, cylindrical shaft	1
35	156.0234	Pin punch, Ø 6 mm, cylindrical shaft	1
36	515.1135	1/2" Impact extension, 125 mm	1
37	515.1133	1/2" Impact universal ball joint	1
38	142.5101	Club hammer, fibreglas handle, 1000 g	1
39	140.5252	Recoil free soft faced hammer, 400 g	1
40	142.1402	Fitters hammer, fibreglas handle, 400 g	1

813.0036

L Pliers and measuring tool set

449,- EUR

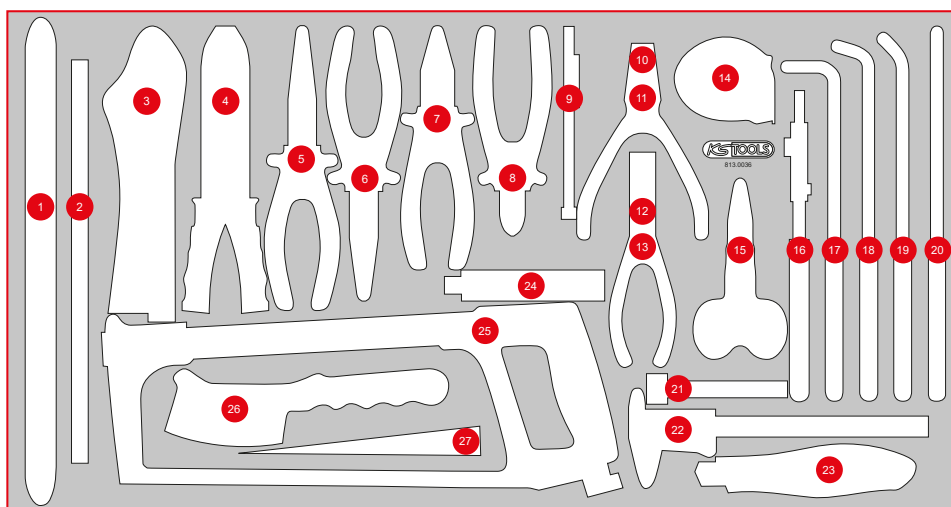

Pos.	Code	Description	pcs
1	911.8146	Tyre lever, 370 mm	1
2	300.0104	Flexible steel rule, 300 mm	1
3	115.1033	Self grip wrench, 220 mm	1
4	115.1231	Multifunction pliers for insulated and non insulated cable terminals, 220 mm	1
5	115.1024	ERGOTORQUE long nose pliers serrated cutter, 200 mm	1
6	115.1019	ERGOTORQUE bent nose pliers serrated, 210 mm	1
7	115.1021	ERGOTORQUE combination pliers, 180 mm	1
8	115.1012	ERGOTORQUE diagonal side cutter, 160 mm	1
9	550.1001	2 in 1 Telescopic solenoid holder with washer jet cleaning and setting tool, 150 - 675 mm	1
10	500.1026	Circlip pliers for external circlips, angled, 160 mm	1
11	500.1029	Circlip pliers for external circlips, 160 mm	1
12	500.1032	Circlip pliers for internal circlips, angled, 160 mm	1
13	500.1035	Circlip pliers for internal circlips, 160 mm	1
14	300.0114	Tape measure with locking device and belt clip, black red, 5m, 19 mm	1
15	118.0013	Uni workshop scissors, 143 mm	1
16	115.2010	Water pump pliers, 240 mm	1
17	500.7053	Telephone pliers 90° curved, extra long, 270mm	1
18	500.7047	Sparkplug plier 12mm	1
19	500.7052	Telephone pliers 45° curved, extra long, 270mm	1
20	500.7051	Telephone pliers, extra long, 270mm	1
21	300.0600	Feeler gauge, 20 Blades, 0,05 - 1 mm	1
22	300.0510	Pocket vernier calliper 0 - 150 mm, 235 mm	1
23	907.2135	Universal snap off blade knife 18 mm	1
24	907.2166	Snap off blades 0,5 x 1,8 x 100 mm, dispenser with 10 pieces	10
25	907.2102	Hacksaw frame, 300mm, with two component handle	1
26	201.2335	Steel wire brake saddle brush, 2-row, straight 225 mm	1
27	911.8138	Trim plastic wedge, 195 mm x B = 30 mm	1

P 10

P 15

P 20

P 25

P 30

P 35

P 40

P 45

L M

S XL

Individual parts

Accessories

813.0030

L Pliers and measuring tool set

359, — *EUR*



755 x 398

P25

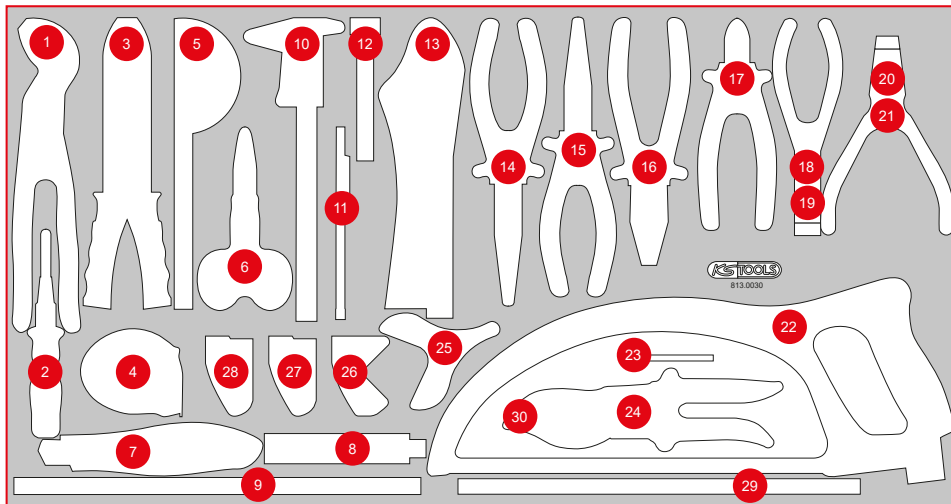

Pos.	Code	Description	pcs
1	115.2010	Water pump pliers, 240 mm	1
2	156.0466	Automatic centre punch, Ø 4 mm	1
3	115.1231	Multifunction pliers for insulated and non insulated cable terminals, 220 mm	1
4	300.0114	Tape measure with locking device and belt clip, black red, 5 m, 19 mm	1
5	300.0700	Protractor with rule, 220mm	1
6	118.0013	Uni workshop scissors, 143 mm	1
7	907.2135	Universal snap off blade knife 18 mm	1
8	907.2166	Snap off blades 0,5 x1 8 x 100 mm, dispenser 10 with 10 pieces	10
9	300.0104	Flexible steel rule, 300 mm	1
10	300.0510	Pocket vernier calliper 0-150 mm, 235 mm	1
11	550.1023	2in1 Telescopic solenoid lifter with washer jet cleaning and setting tool, 150-590mm	1
12	300.0600	Feeler gauge, 20 Blades, 0,05 - 1 mm	1
13	115.1033	Self grip wrench, 220 mm	1
14	115.1024	ERGOTORQUE long nose pliers serrated cutter, 200 mm	1
15	115.1019	ERGOTORQUE bent nose pliers serrated, 210 mm	1
16	115.1021	ERGOTORQUE combination pliers, 180 mm	1
17	115.1012	ERGOTORQUE diagonal side cutter, 160 mm	1
18	500.1032	Circlip pliers for internal circlips, angled, 160 mm	1
19	500.1035	Circlip pliers for internal circlips, 160 mm	1
20	500.1026	Circlip pliers for external circlips, angled, 160 mm	1
21	500.1029	Circlip pliers for external circlips, 160 mm	1
22	907.2115	Hacksaw frame, 300 mm	1
23	151.2604	Hexagon key wrench phosphate finish, short, 4mm	1
24	123.0076	Scissor-shaped with blades	1
25	123.0086	angular stop	1
26	123.0079	prism for 90° profile	1
27	123.0078	fitting for Ø 25 mm	1
28	123.0077	fitting for Ø 16 and 19 mm	1
29	129.6620-24	HSS Bi Co 8 metal high performance saw blades 1,0mm	1
30	123.0084	straight fitting	1



P 10

P 15

P 20

P 25

P 30

P 35

P 40

P 45

L M

S XL

Individual parts

Accessories

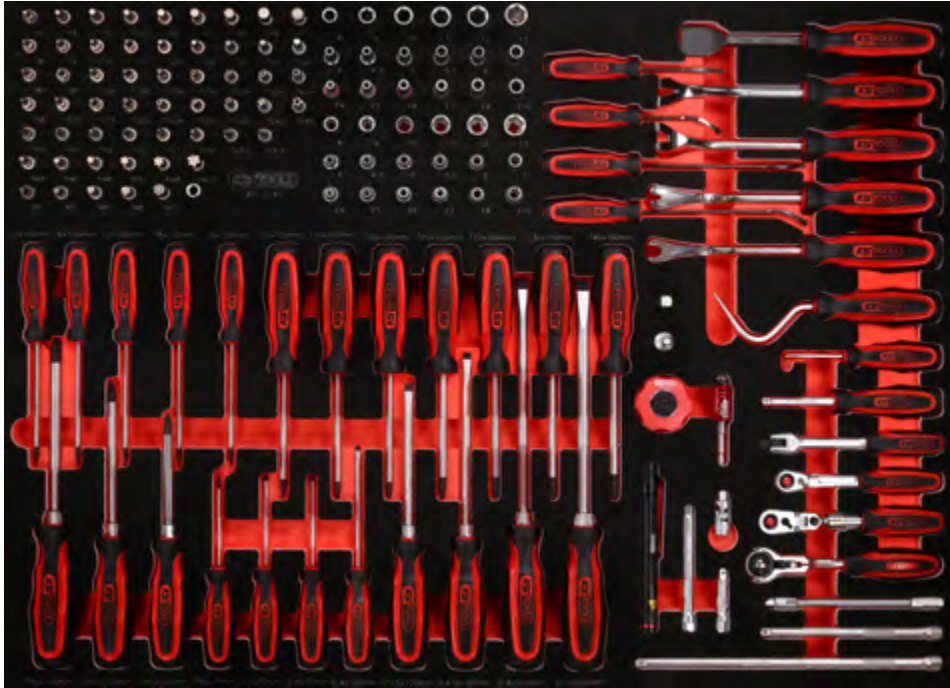
XL 1/4" Socket spanner and screwdriver set**419,^{EUR}-**

142

790 x 568

P20

P30

P45

Pos.	Code	Description	pcs	Pos.	Code	Description	pcs	Pos.	Code	Description	pcs
1	911.1436	1/4" Bit socket hexagon, 3 mm	1	27	911.1468	TX bit socket tamperproof, 1/4", TB40	1	54	917.1545	1/4" Bit socket spline (XZN), M8	1
2	911.1437	1/4" Bit socket hexagon, 4 mm	1	28	917.1578	1/4" Torx Plus Bit-Socket 8IPR	1	55	917.1546	1/4" Bit socket spline (XZN), M10	1
3	911.1438	1/4" Bit socket hexagon, 5 mm	1	29	911.1701	1/4" Bit socket five star tamperproof, TS10	1	56	911.0101	1/4" socket with magnet	1
4	911.14385	1/4" Bit socket hexagon, 5,5 mm	1	30	911.1702	1/4" Bit socket five star tamperproof, TS15	1	57	917.1428	1/4" Hexagonal socket, deep, 8 mm	1
5	911.1439	1/4" Bit socket hexagon, 6 mm	1	31	911.1703	1/4" Bit socket five star tamperproof, TS20	1	58	917.1429	1/4" Hexagonal socket, deep, 9 mm	1
6	911.1440	1/4" Bit socket hexagon, 7 mm	1	32	911.1704	1/4" Bit socket five star tamperproof, TS25	1	59	917.1430	1/4" Hexagonal socket, deep, 10 mm	1
7	911.1441	1/4" Bit socket hexagon, 8 mm	1	33	911.1705	1/4" Bit socket five star tamperproof, TS27	1	60	917.1431	1/4" Hexagonal socket, deep, 11 mm	1
8	917.1454	1/4" Bit socket hexagon, 9 mm	1	34	911.1706	1/4" Bit socket five star tamperproof, TS30	1	61	917.1432	1/4" Hexagonal socket, deep, 12 mm	1
9	917.1452	1/4" Bit socket hexagon, 10 mm	1	35	911.1707	1/4" Bit socket five star tamperproof, TS40	1	62	917.1433	1/4" Hexagonal socket, deep, 13 mm	1
10	911.1448	1/4" Bit socket Torx, T8	1	36	911.1708	1/4" Bit socket five star tamperproof, TS45	1	63	917.1525	1/4" Hexagonal socket, deep, 4 mm	1
11	911.1478	1/4" Bit socket Torx, T9	1	37	911.1482	1/4" Bit socket, PH0	1	64	917.1526	1/4" Hexagonal socket, deep, 4,5 mm	1
12	911.1442	1/4" Bit socket Torx, T10	1	38	911.1415	1/4" Bit socket, PH1	1	65	917.1527	1/4" Hexagonal socket, deep, 5 mm	1
13	911.1443	1/4" Bit socket Torx, T15	1	39	911.1416	1/4" Bit socket, PH2	1	66	917.1528	1/4" Hexagonal socket, deep, 5,5 mm	1
14	911.1444	1/4" Bit socket Torx, T20	1	40	911.1483	1/4" Bit socket, PZ0	1	67	917.1426	1/4" Hexagonal socket, deep, 6 mm	1
15	911.1445	1/4" Bit socket Torx, T25	1	41	911.1401	1/4" Bit socket, PZ1	1	68	917.1427	1/4" Hexagonal socket, deep, 7 mm	1
16	911.1449	1/4" Bit socket Torx, T27	1	42	911.1402	1/4" Bit socket, PZ2	1	69	917.2401	1/4 Torx E Socket, deep E4	1
17	911.1446	1/4" Bit socket Torx, T30	1	43	911.1419	1/4" Bit socket slot, 5,5 mm	1	70	917.2402	1/4 Torx E Socket, deep E5	1
18	911.1447	1/4" Bit socket Torx, T40	1	44	917.1421	1/4" Bit socket slot, 6,5 mm	1	71	917.2403	1/4 Torx E Socket, deep E6	1
19	911.1461	TX bit socket tamperproof, 1/4", TB8	1	45	917.1584	1/4" RIBE Socket M4S	1	72	917.2404	1/4 Torx E Socket, deep E7	1
20	911.1485	TX bit socket tamperproof, 1/4", TB9	1	46	917.1585	1/4" RIBE Socket M5S	1	73	917.2405	1/4 Torx E Socket, deep E8	1
21	911.1462	TX bit socket tamperproof, 1/4", TB10	1	47	917.1586	1/4" RIBE Socket M6S	1	74	917.2406	1/4 Torx E Socket, deep E10	1
22	911.1463	TX bit socket tamperproof, 1/4", TB15	1	48	917.1587	1/4" RIBE Socket M7S	1	75	917.1408	1/4" Hexagonal socket, 8 mm	1
23	911.1464	TX bit socket tamperproof, 1/4", TB20	1	49	917.1588	1/4" RIBE Socket M8S	1	76	917.1409	1/4" Hexagonal socket, 9 mm	1
24	911.1465	TX bit socket tamperproof, 1/4", TB25	1	50	917.1590	1/4" RIBE Socket M10S	1	77	917.1410	1/4" Hexagonal socket, 10 mm	1
25	911.1466	TX bit socket tamperproof, 1/4", TB27	1	51	917.1541	1/4" Bit socket spline (XZN), M4	1	78	917.1411	1/4" Hexagonal socket, 11 mm	1
26	911.1467	TX bit socket tamperproof, 1/4", TB30	1	52	917.1542	1/4" Bit socket spline (XZN), M5	1	79	917.1412	1/4" Hexagonal socket, 12 mm	1
				53	917.1543	1/4" Bit socket spline (XZN), M6	1	80	917.1413	1/4" Hexagonal socket, 13 mm	1

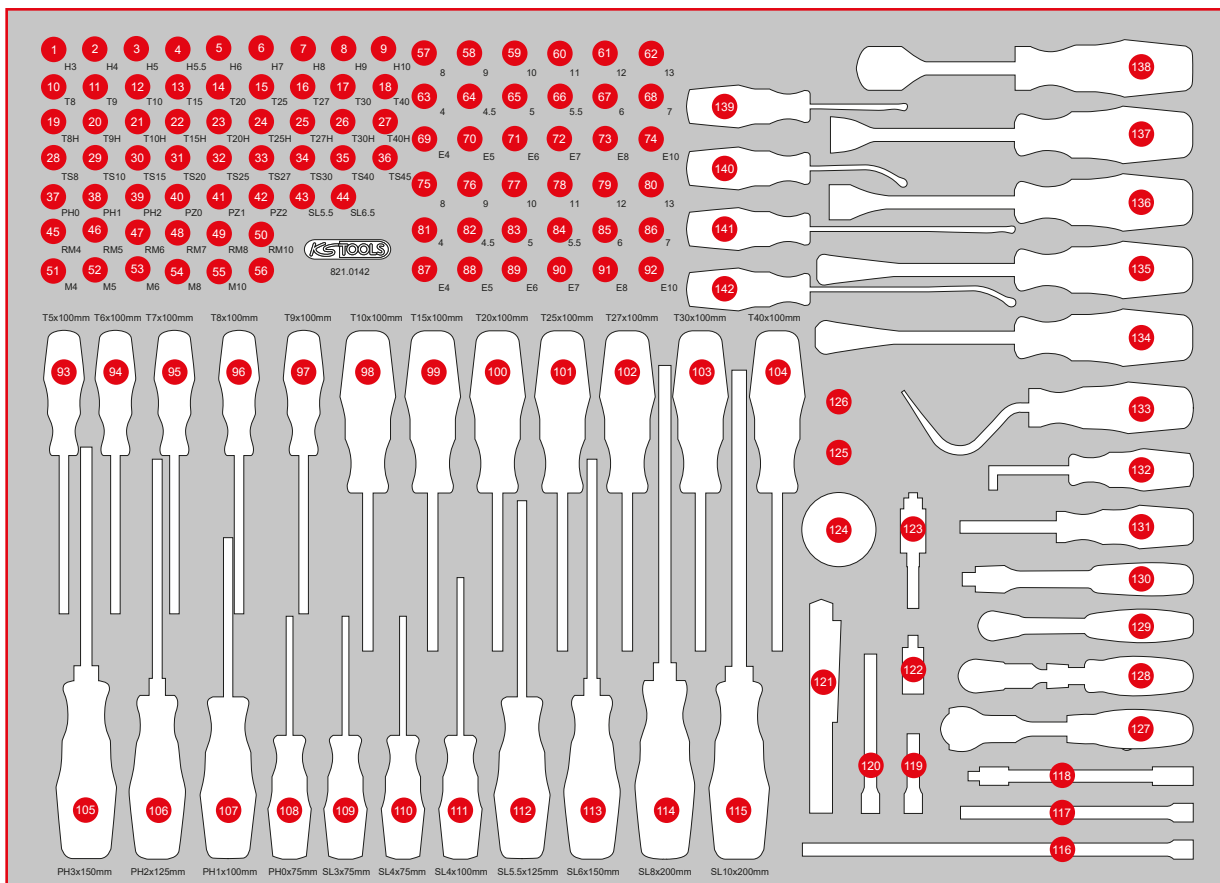

Pos.	Code	Description	pcs	Pos.	Code	Description	pcs	Pos.	Code	Description	pcs
81	917.1404	1/4" Hexagonal socket, 4 mm	1	107	159.1029	ERGOTORQUEplus screwdriver for screws PH1, L = 205 mm	1	127	914.1405	1/4" MODIFIX mini T-handle swivel head ratchet, 72 teeth	1
82	917.14045	1/4" Hexagonal socket, 4,5 mm	1	108	159.1027	ERGOTORQUEplus screwdriver for screws PH0, L = 155 mm	1	128	914.1420	1/4" SlimPOWER telescopic-joint reversible ratchet, 72 teeth	1
83	917.1405	1/4" Hexagonal socket, 5 mm	1	109	159.1002	ERGOTORQUEplus screwdriver for slotted screws, 3 mm, L = 155 mm	1	129	920.1490	1/4" SlimPOWER Reversible ratchet, 72 teeth	1
84	917.14055	1/4" Hexagonal socket, 5,5 mm	1	110	159.1003	ERGOTORQUEplus screwdriver for slotted screws, 4 mm, L = 155 mm	1	130	917.1488	1/4" Flexi head drive handle	1
85	917.1406	1/4" Hexagonal socket, 6 mm	1	111	159.1004	ERGOTORQUEplus screwdriver for slotted screws, 4 mm, L = 180 mm	1	131	911.1434	1/4" Square drive screwdriver, 150 mm	1
86	917.1407	1/4" Hexagonal socket, 7 mm	1	112	159.1006	ERGOTORQUEplus screwdriver for slotted screws, 5,5 mm, L = 230 mm	1	132	550.1048	Hook, 90° offset	1
87	911.4313	1/4" Torx E Socket, E4	1	113	159.1009	ERGOTORQUEplus screwdriver for slotted screws, 6,5 mm, L = 255 mm	1	133	550.1073	Hook, large, sickle	1
88	911.4314	1/4" Torx E Socket, E5	1	114	159.1011	ERGOTORQUEplus screwdriver for slotted screws, 8 mm, L = 315 mm	1	134	140.2373	Clip remover short, length 245 mm, opening 10 mm	1
89	911.4315	1/4" Torx E Socket, E6	1	115	159.1012	ERGOTORQUEplus screwdriver for slotted screws, 10 mm, L = 315 mm	1	135	140.2371	Clip remover short, length 245 mm, opening 4 mm	1
90	911.4316	1/4" Torx E Socket, E7	1	116	911.1504	1/4" Extension with hexagon drive, 250 mm	1	136	140.2615	Clip remover, short 9 mm	1
91	911.4317	1/4" Torx E Socket, E8	1	117	911.1451	1/4" Extension with hexagon drive, 150 mm	1	137	140.2616	Clip remover, short 7,5 mm	1
92	911.4332	1/4" Torx E Socket, E10	1	118	911.1422	1/4" Flexible Extensions, 150 mm	1	138	907.2222	Gasket scraper, 25 x 200 mm	1
93	159.1133	ERGOTORQUEplus screwdriver, Torx T5	1	119	911.1423	1/4" Extension with hexagon drive, 50 mm	1	139	140.2613	Panel lever 3 x 63 mm, bent	1
94	159.1134	ERGOTORQUEplus screwdriver, Torx T6	1	120	911.1424	1/4" Extension with hexagon drive, 100 mm	1	140	140.2611	Panel lever 3 x 63 mm	1
95	159.1135	ERGOTORQUEplus screwdriver, Torx T7	1	121	150.4370	perfectLight torch 85 lumen	1	141	140.2612	Panel lever 3 x 133 mm	1
96	159.1030	ERGOTORQUEplus screwdriver, Torx, T8	1	122	911.1450	1/4" Universal joint	1	142	140.2614	Panel lever 3 x 133 mm, bent	1
97	159.1031	ERGOTORQUEplus screwdriver, Torx, T9	1	123	514.1126	2in1 quick-replacement bit holder	1				
98	159.1032	ERGOTORQUEplus screwdriver, Torx, T10	1	124	914.1410	1/4" HandReversible ratchet	1				
99	159.1033	ERGOTORQUEplus screwdriver, Torx, T15	1	125	911.3897	3/8" Reducing adaptor, 3/8" F x 1/4" M	1				
100	159.1034	ERGOTORQUEplus screwdriver, Torx, T20	1	126	911.1494	Adaptor, 1/4"Mx3/8"F	1				
101	159.1035	ERGOTORQUEplus screwdriver, Torx, T25	1								
102	159.1036	ERGOTORQUEplus screwdriver, Torx, T27	1								
103	159.1037	ERGOTORQUEplus screwdriver, Torx, T30	1								
104	159.1038	ERGOTORQUEplus screwdriver, Torx, T40	1								
105	159.1024	ERGOTORQUEplus screwdriver for screws PH3, L = 265 mm	1								
106	159.1022	ERGOTORQUEplus screwdriver for screws PH2, L = 230 mm	1								

P 10
P 15
P 20
P 25
P 30
P 35
P 40
P 45
Individual parts
S XL L M
Accessories

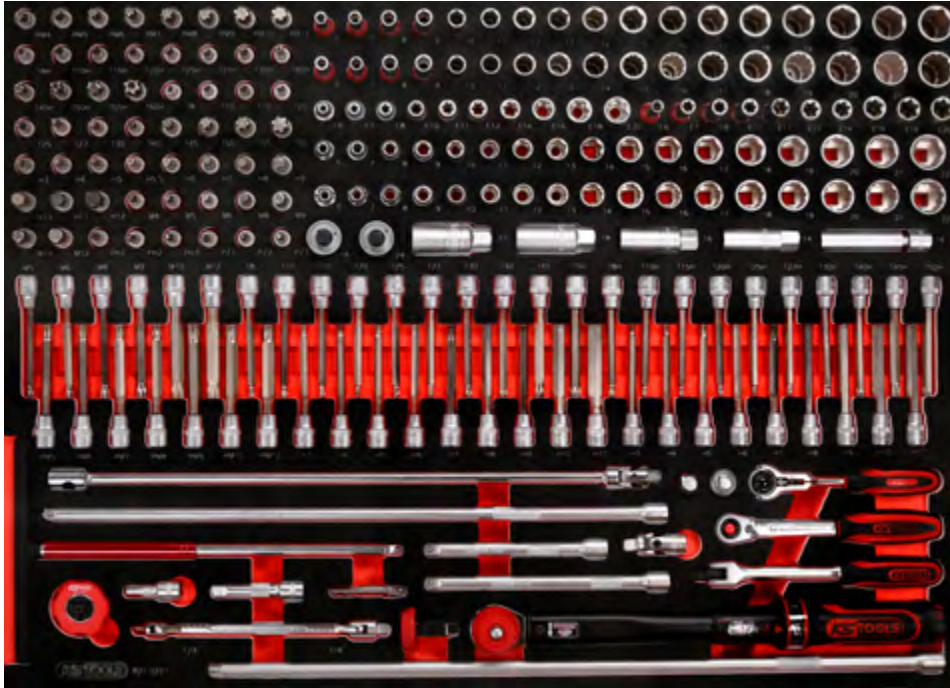
XL 3/8" Socket spanner set**419,-^{EUR}**

221



Pos.	Code	Description	pcs	Pos.	Code	Description	pcs	Pos.	Code	Description	pcs
1	917.3921	3/8" RIBE® Bit socket, M4	1	39	911.3868	3/8" Bit socket hexagon, 8 mm	1	77	917.3856	3/8" 12 Point socket, deep, 9 mm	1
2	917.3922	3/8" RIBE® Bit socket, M5	1	40	917.3969	3/8" Bit socket hexagon, 9 mm	1	78	917.3970	3/8" 12 Point socket, deep, 10 mm	1
3	917.3923	3/8" RIBE® Bit socket, M6	1	41	917.3857	3/8" Bit socket hexagon, 10 mm	1	79	917.3971	3/8" 12 Point socket, deep, 11 mm	1
4	917.3924	3/8" RIBE® Bit socket, M7	1	42	917.3992	3/8" Bit socket hexagon, 11 mm	1	80	917.3972	3/8" 12 Point socket, deep, 12 mm	1
5	917.3925	3/8" RIBE® Bit socket, M8	1	43	911.3862	3/8" Bit socket hexagon, 12 mm	1	81	917.3973	3/8" 12 Point socket, deep, 13 mm	1
6	917.3926	3/8" RIBE® Bit socket, M9	1	44	911.3918	3/8" Bit socket spline (XZN), M4	1	82	917.3974	3/8" 12 Point socket, deep, 14 mm	1
7	917.3927	3/8" RIBE® Bit socket, M10	1	45	911.3915	3/8" Bit socket spline (XZN), M5	1	83	917.3975	3/8" 12 Point socket, deep, 15 mm	1
8	917.3928	3/8" RIBE® Bit socket, M12	1	46	911.3916	3/8" Bit socket spline (XZN), M6	1	84	917.3976	3/8" 12 Point socket, deep, 16 mm	1
9	917.3929	3/8" Bit socket Torx tamperproof, TB 8	1	47	911.3917	3/8" Bit socket spline (XZN), M8	1	85	917.3977	3/8" 12 Point socket, deep, 17 mm	1
10	911.3960	3/8" Bit socket Torx tamperproof, TB 10	1	48	917.3901	3/8" Bit socket spline (XZN), M9	1	86	917.3978	3/8" 12 Point socket, deep, 18 mm	1
11	911.3961	3/8" Bit socket Torx tamperproof, TB 15	1	49	911.3920	3/8" Bit socket spline (XZN), M10	1	87	917.3979	3/8" 12 Point socket, deep, 19 mm	1
12	911.3962	3/8" Bit socket Torx tamperproof, TB 20	1	50	917.3903	3/12" Bit socket spline (XZN), M12	1	88	917.3980	3/8" 12 Point socket, deep, 20 mm	1
13	911.3963	3/8" Bit socket Torx tamperproof, TB 25	1	51	911.3875	3/8" Bit socket, PH1	1	89	917.3981	3/8" 12 Point socket, deep, 21 mm	1
14	911.3964	3/8" Bit socket Torx tamperproof, TB 27	1	52	911.3876	3/8" Bit socket, PH2	1	90	917.3982	3/8" 12 Point socket, deep, 22 mm	1
15	911.3965	3/8" Bit socket Torx tamperproof, TB 30	1	53	911.3877	3/8" Bit socket, PH3	1	91	911.4340	3/8" Torx E Socket, E6	1
16	911.3966	3/8" Bit socket Torx tamperproof, TB 40	1	54	911.3881	3/8" Bit socket, PZ1	1	92	911.4341	3/8" Torx E Socket, E7	1
17	911.3967	3/8" Bit socket Torx tamperproof, TB 45	1	55	911.3882	3/8" Bit socket, PZ2	1	93	911.4342	3/8" Torx E Socket, E8	1
18	911.3968	3/8" Bit socket Torx tamperproof, TB 50	1	56	911.3883	3/8" Bit socket, PZ3	1	94	911.4318	3/8" Torx E Socket, E10	1
19	911.3969	3/8" Bit socket Torx tamperproof, TB 55	1	57	917.4806	3/8" Hexagonal socket, deep, 6mm	1	95	911.4319	3/8" Torx E Socket, E11	1
20	911.3970	3/8" Bit socket Torx tamperproof, TB 60	1	58	917.4807	3/8" Hexagonal socket, deep, 7mm	1	96	911.4320	3/8" Torx E Socket, E12	1
21	911.3934	3/8" Bit socket Torx, T8	1	59	917.3828	3/8" Hexagonal socket, deep, 8mm	1	97	911.4321	3/8" Torx E Socket, E14	1
22	911.3887	3/8" Bit socket Torx, T10	1	60	917.3829	3/8" Hexagonal socket, deep, 9mm	1	98	911.4343	3/8" Torx E Socket, E16	1
23	911.3869	3/8" Bit socket Torx, T15	1	61	917.3830	3/8" Hexagonal socket, deep, 10mm	1	99	911.4344	3/8" Torx E Socket, E18	1
24	911.3870	3/8" Bit socket Torx, T20	1	62	917.3831	3/8" Hexagonal socket, deep, 11mm	1	100	911.4345	3/8" Torx E Socket, E20	1
25	911.3871	3/8" Bit socket Torx, T25	1	63	917.3832	3/8" Hexagonal socket, deep, 12mm	1	101	911.4386	3/8" Torx E Socket, E6, long	1
26	911.3872	3/8" Bit socket Torx, T27	1	64	917.3833	3/8" Hexagonal socket, deep, 13mm	1	102	911.4387	3/8" Torx E Socket, E7, long	1
27	911.3873	3/8" Bit socket Torx, T30	1	65	917.3834	3/8" Hexagonal socket, deep, 14mm	1	103	911.4388	3/8" Torx E Socket, E8, long	1
28	911.3874	3/8" Bit socket Torx, T40	1	66	917.3835	3/8" Hexagonal socket, deep, 15mm	1	104	911.4390	3/8" Torx E Socket, E10, long	1
29	911.3885	3/8" Bit socket Torx, T45	1	67	917.3836	3/8" Hexagonal socket, deep, 16mm	1	105	911.4391	3/8" Torx E Socket, E11, long	1
30	911.3884	3/8" Bit socket Torx, T50	1	68	917.3837	3/8" Hexagonal socket, deep, 17mm	1	106	911.4392	3/8" Torx E Socket, E12, long	1
31	911.3888	3/8" Bit socket Torx, T55	1	69	917.3838	3/8" Hexagonal socket, deep, 18mm	1	107	911.4394	3/8" Torx E Socket, E14, long	1
32	911.3889	3/8" Bit socket Torx, T60	1	70	917.3839	3/8" Hexagonal socket, deep, 19mm	1	108	911.4396	3/8" Torx E Socket, E16, long	1
33	911.3863	3/8" Bit socket hexagon, 3 mm	1	71	917.3840	3/8" Hexagonal socket, deep, 20mm	1	109	911.4398	3/8" Torx E Socket, E18, long	1
34	911.3864	3/8" Bit socket hexagon, 4 mm	1	72	917.3841	3/8" Hexagonal socket, deep, 21mm	1	110	911.4399	3/8" Torx E Socket, E20, long	1
35	911.3865	3/8" Bit socket hexagon, 5 mm	1	73	917.3842	3/8" Hexagonal socket, deep, 22 mm	1	111	917.3806	3/8" Hexagonal socket, 6 mm	1
36	911.38655	3/8" Bit socket hexagon, 5, 5 mm	1	74	917.4831	3/8" 12 Point socket, deep, 6mm	1	112	917.3807	3/8" Hexagonal socket, 7 mm	1
37	911.3866	3/8" Bit socket hexagon, 6 mm	1	75	917.4832	3/8" 12 Point socket, deep, 7mm	1	113	917.3808	3/8" Hexagonal socket, 8 mm	1
38	911.3867	3/8" Bit socket hexagon, 7 mm	1	76	917.3855	3/8" 12 Point socket, deep, 8 mm	1	114	917.3809	3/8" Hexagonal socket, 9 mm	1

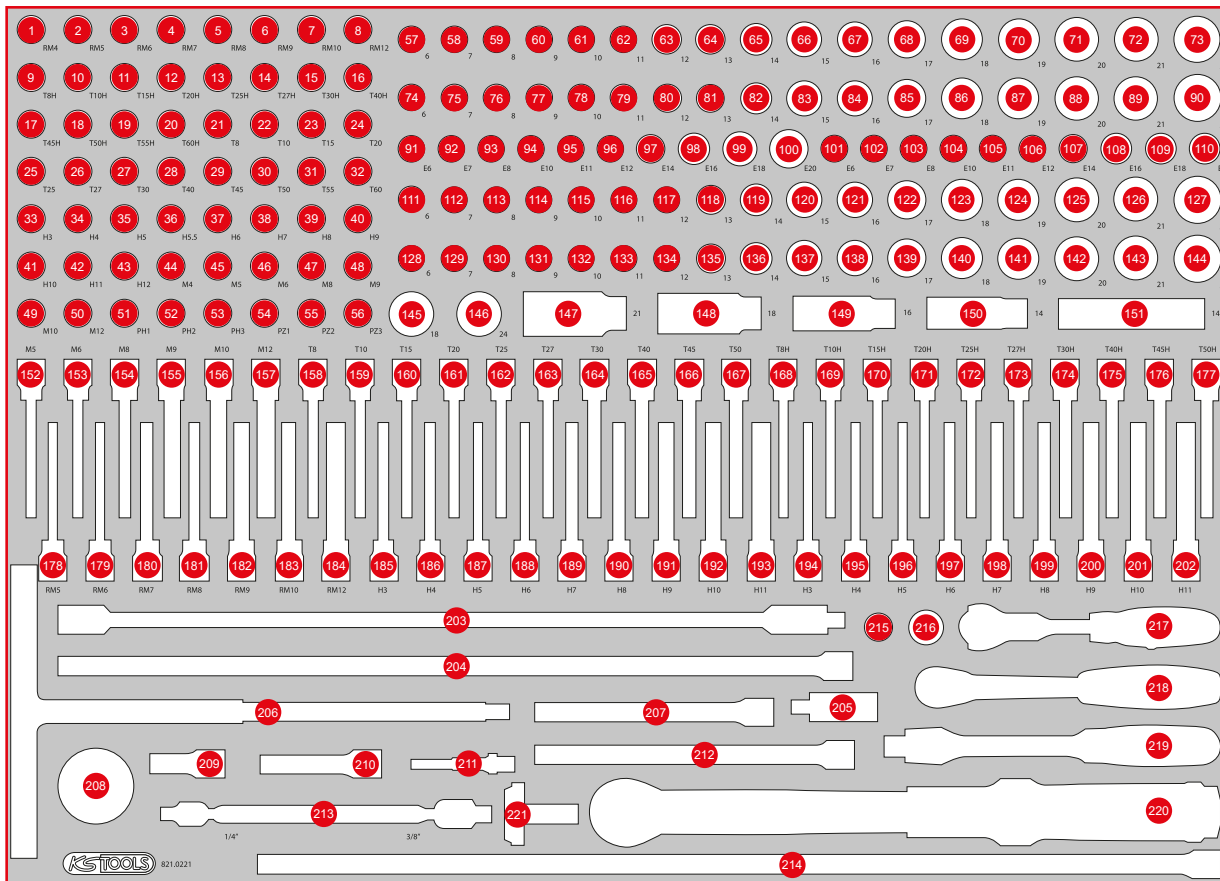

Pos.	Code	Description	pcs	Pos.	Code	Description	pcs	Pos.	Code	Description	pcs
115	917.3810	3/8" Hexagonal socket, 10 mm	1	152	917.3904	XZN spline bit socket, 3/8", M5, long	1	190	911.1565	3/8" Bit socket hexagon, long, 8 mm	1
116	917.3811	3/8" Hexagonal socket, 11 mm	1	153	917.3905	XZN spline bit socket, 3/8", M6, long	1	191	917.1594	3/8" Bit socket hexagon, long, 9 mm	1
117	917.3812	3/8" Hexagonal socket, 12 mm	1	154	917.3906	XZN spline bit socket, 3/8", M8, long	1	192	911.1566	3/8" Bit socket hexagon, long, 10 mm	1
118	917.3813	3/8" Hexagonal socket, 13 mm	1	155	917.3907	XZN spline bit socket, 3/8", M9, long	1	193	917.1595	3/8" Bit socket hexagon, long, 11 mm	1
119	917.3814	3/8" Hexagonal socket, 14 mm	1	156	917.3908	XZN spline bit socket, 3/8", M10, long	1	194	911.5393	Hex bit socket with ball end, 3/8", 3 mm	1
120	917.3815	3/8" Hexagonal socket, 15 mm	1	157	917.3909	XZN spline bit socket, 3/8", M12, long	1	195	911.5394	Hex bit socket with ball end, 3/8", 4 mm	1
121	917.3816	3/8" Hexagonal socket, 16 mm	1	158	917.1576	3/8" Bit socket Torx, long, T8	1	196	911.5395	Hex bit socket with ball end, 3/8", 5 mm	1
122	917.3817	3/8" Hexagonal socket, 17 mm	1	159	917.1577	3/8" Bit socket Torx, long, T10	1	197	911.5396	Hex bit socket with ball end, 3/8", 6 mm	1
123	917.3818	3/8" Hexagonal socket, 18 mm	1	160	917.1579	3/8" Bit socket Torx, long, T15	1	198	911.5397	Hex bit socket with ball end, 3/8", 7 mm	1
124	917.3819	3/8" Hexagonal socket, 19 mm	1	161	911.1551	3/8" Bit socket Torx, long, T20	1	199	911.5398	Hex bit socket with ball end, 3/8", 8 mm	1
125	917.3820	3/8" Hexagonal socket, 20 mm	1	162	911.1552	3/8" Bit socket Torx, long, T25	1	200	911.5399	Hex bit socket with ball end, 3/8", 9 mm	1
126	917.3821	3/8" Hexagonal socket, 21 mm	1	163	911.1553	3/8" Bit socket Torx, long, T27	1	201	911.5390	Hex bit socket with ball end, 3/8", 10 mm	1
127	917.3822	3/8" Hexagonal socket, 22 mm	1	164	911.1554	3/8" Bit socket Torx, long, T30	1	202	911.5391	Hex bit socket with ball end, 3/8", 11 mm	1
128	917.3804	3/8" 12 Point socket, 6 mm	1	165	911.1555	3/8" Bit socket Torx, long, T40	1	203	517.1126	T-Handle universal wrench for sockets, extra long, 3/8"	1
129	917.3805	3/8" 12 Point socket, 7 mm	1	166	911.1556	3/8" Bit socket Torx, long, T45	1	204	911.4884	3/8" Extensions 500 mm	1
130	911.3981	3/8" 12 Point socket, 8 mm	1	167	911.1557	3/8" Bit socket Torx, long, T50	1	205	911.3850	3/8" Universal joint	1
131	911.3982	3/8" 12 Point socket, 9 mm	1	168	917.3938	3/8" Bit socket Torx tamperproof, long, TB 8	1	206	911.3931	3/8" T-Handle-Spinner	1
132	911.3983	3/8" 12 Point socket, 10 mm	1	169	917.3937	3/8" Bit socket Torx tamperproof, long, TB 10	1	207	911.3802	3/8" Extensions 150 mm	1
133	911.3984	3/8" 12 Point socket, 11 mm	1	170	911.3939	3/8" Bit socket Torx tamperproof, long, TB 15	1	208	914.3810	3/8" HandReversible ratchet	1
134	911.3985	3/8" 12 Point socket, 12 mm	1	171	911.3971	3/8" Bit socket Torx tamperproof, long, TB 20	1	209	911.3852	3/8" Extensions 45 mm	1
135	911.3986	3/8" 12 Point socket, 13 mm	1	172	911.3972	3/8" Bit socket Torx tamperproof, long, TB 25	1	210	911.3801	3/8" Extensions 75 mm	1
136	911.3987	3/8" 12 Point socket, 14 mm	1	173	911.3973	3/8" Bit socket Torx tamperproof, long, TB 27	1	211	514.1107	Socket adaptor, 1/4"x3/8"	1
137	911.3988	3/8" 12 Point socket, 15 mm	1	174	911.3974	3/8" Bit socket Torx tamperproof, long, TB 30	1	212	911.3856	3/8" Extensions 200 mm	1
138	911.3989	3/8" 12 Point socket, 16 mm	1	175	911.3975	3/8" Bit socket Torx tamperproof, long, TB 40	1	213	517.0338	Double-joint-spanner for 1/4" and 3/8" sockets	1
139	911.3992	3/8" 12 Point socket, 17 mm	1	176	911.3976	3/8" Bit socket Torx tamperproof, long, TB 45	1	214	911.4892	3/8" Flexi head drive handle	1
140	911.3993	3/8" 12 Point socket, 18 mm	1	177	911.3977	3/8" Bit socket Torx tamperproof, long, TB 50	1	215	911.3892	Adaptor, 3/8" Fx1/2" M	1
141	911.3994	3/8" 12 Point socket, 19 mm	1	178	917.3930	3/8" RIBE® Bit socket, long, M5	1	216	911.1233	Reducing adaptor, 1/2" F x 3/8" M	1
142	917.4811	3/8" 12 Point socket, 20 mm	1	179	917.3931	3/8" RIBE® Bit socket, long, M6	1	217	914.3815	3/8" MODIFIX mini T-handle swivel head ratchet, 72 teeth, 0°+90°	1
143	911.3996	3/8" 12 Point socket, 21 mm	1	180	917.3932	3/8" RIBE® Bit socket, long, M7	1	218	920.3890	3/8" SlimPOWER Reversible ratchet, 72 teeth	1
144	911.3997	3/8" 12 Point socket, 22 mm	1	181	917.3933	3/8" RIBE® Bit socket, long, M8	1	219	917.3939	3/8" Flexi head drive handle	1
145	516.1501	Torque limiter for spark plugs, 3/8", 18Nm	1	182	917.3934	3/8" RIBE® Bit socket, long, M9	1	220	516.1432	1/2" ERGOTORQUE® precision torque wrench with rotary mushroom ratchet head, 20-100Nm	1
146	516.1502	Torque limiter for spark plugs, 3/8", 24Nm	1	183	917.3935	3/8" RIBE® Bit socket, long, M10	1	221	516.1428	Rotary square box wrench, 1/2"x3/8"	1
147	911.3805	3/8" Spark plug socket, 21 mm	1	184	917.3936	3/8" RIBE® Bit socket, long, M12	1				
148	911.3823	3/8" Spark plug socket, 18 mm	1	185	917.1593	3/8" Bit socket hexagon, long, 3 mm	1				
149	911.3804	3/8" Spark plug socket, 16 mm	1	186	911.1561	3/8" Bit socket hexagon, long, 4 mm	1				
150	911.3990	3/8" Spark plug socket, 14 mm	1	187	911.1562	3/8" Bit socket hexagon, long, 5 mm	1				
151	911.3999	3/8" Special spark plug socket for BMW with flexible joint, 14mm	1	188	911.1563	3/8" Bit socket hexagon, long, 6 mm	1				
				189	911.1564	3/8" Bit socket hexagon, long, 7 mm	1				

P 10
P 15
P 20
P 25
P 30
P 35
P 40
P 45
Individual parts S XL L M
Accessories

821.0149

XL 1/2" Socket spanner set



779,-^{EUR}

149

790 x 568



Pos.	Code	Description	pcs	Pos.	Code	Description	pcs	Pos.	Code	Description	pcs
1	911.1304	1/2" Bit socket hexagon, short, 4 mm	1	28	911.1343	1/2" Bit socket spline (XZN), M10, 55 mm	1	54	917.1316	1/2" Bit socket hexagon, short, 3/16"	1
2	911.1305	1/2" Bit socket hexagon, short, 5 mm	1	29	911.1344	1/2" Bit socket spline (XZN), M12, 55 mm	1	55	917.1318	1/2" Bit socket hexagon, short, 1/4"	1
3	911.13055	1/2" Bit socket hexagon, short, 5,5 mm	1	30	911.1345	1/2" Bit socket spline (XZN), M14, 55 mm	1	56	917.1319	1/2" Bit socket hexagon, short, 9/32"	1
4	911.1306	1/2" Bit socket hexagon, short, 6 mm	1	31	911.1346	1/2" Bit socket spline (XZN), M16, 55 mm	1	57	917.1320	1/2" Bit socket hexagon, short, 5/16"	1
5	911.1307	1/2" Bit socket hexagon, short, 7 mm	1	32	911.5306	1/2" Bit socket spline (XZN), M17, 55 mm	1	58	911.5386	1/2" Bit socket hexagon, short, 11/32"	1
6	911.1308	1/2" Bit socket hexagon, short, 8 mm	1	33	911.1348	1/2" Bit socket spline (XZN) tamperproof, M16, 55 mm	1	59	917.1321	1/2" Bit socket hexagon, short, 3/8"	1
7	911.1309	1/2" Bit socket hexagon, short, 9 mm	1	34	911.1361	1/2" Bit socket Torx, T20	1	60	911.5387	1/2" Bit socket hexagon, short, 7/16"	1
8	911.1310	1/2" Bit socket hexagon, short, 10 mm	1	35	911.1362	1/2" Bit socket Torx, T25	1	61	917.1322	1/2" Bit socket hexagon, short, 1/2"	1
9	911.1312	1/2" Bit socket hexagon, short, 12 mm	1	36	911.1363	1/2" Bit socket Torx, T27	1	62	917.1323	1/2" Bit socket hexagon, short, 9/16"	1
10	911.1314	1/2" Bit socket hexagon, short, 14 mm	1	37	911.1364	1/2" Bit socket Torx, T30	1	63	917.1324	1/2" Bit socket hexagon, short, 5/8"	1
11	911.1317	1/2" Bit socket hexagon, short, 17 mm	1	38	911.1365	1/2" Bit socket Torx, T40	1	64	911.1581	1/2" 12 Point socket, 21 mm	1
12	911.1319	1/2" Bit socket hexagon, short, 19 mm	1	39	911.1366	1/2" Bit socket Torx, T45	1	65	911.1582	1/2" 12 Point socket, 22 mm	1
13	911.4511	Bit socket for RIBE screws, M5, length 55 mm	1	40	911.1367	1/2" Bit socket Torx, T50	1	66	911.1583	1/2" 12 Point socket, 23 mm	1
14	911.4512	Bit socket for RIBE screws, M6, length 55 mm	1	41	911.1368	1/2" Bit socket Torx, T55	1	67	911.1584	1/2" 12 Point socket, 24 mm	1
15	911.4513	Bit socket for RIBE screws, M7, length 55 mm	1	42	911.1369	1/2" Bit socket Torx, T60	1	68	917.1364	1/2" 12 Point socket, 26 mm	1
16	911.4514	Bit socket for RIBE screws, M8, length 55 mm	1	43	911.1370	1/2" Bit socket Torx, T70	1	69	911.1585	1/2" 12 Point socket, 27 mm	1
17	911.4515	Bit socket for RIBE screws, M9, length 55 mm	1	44	911.1371	1/2" Bit socket Torx tamperproof, TB20	1	70	917.1365	1/2" 12 Point socket, 28 mm	1
18	911.4516	Bit socket for RIBE screws, M10, length 55 mm	1	45	911.1372	1/2" Bit socket Torx tamperproof, TB25	1	71	911.1586	1/2" 12 Point socket, 30 mm	1
19	911.4551	Bit socket for RIBE screws, M10.1, length 55 mm	1	46	911.1373	1/2" Bit socket Torx tamperproof, TB27	1	72	911.1587	1/2" 12 Point socket, 32 mm	1
20	911.4517	Bit socket for RIBE screws, M12, length 55 mm	1	47	911.1374	1/2" Bit socket Torx tamperproof, TB30	1	73	911.1570	1/2" 12 Point socket, 10 mm	1
21	911.4518	Bit socket for RIBE screws, M13, length 55 mm	1	48	911.1375	1/2" Bit socket Torx tamperproof, TB40	1	74	911.1571	1/2" 12 Point socket, 11 mm	1
22	911.4519	Bit socket for RIBE screws, M14, length 55 mm	1	49	911.1376	1/2" Bit socket Torx tamperproof, TB45	1	75	911.1572	1/2" 12 Point socket, 12 mm	1
23	911.4552	Bit socket for RIBE screws, M16, length 55 mm	1	50	911.1377	1/2" Bit socket Torx tamperproof, TB50	1	76	911.1573	1/2" 12 Point socket, 13 mm	1
24	911.1340	1/2" Bit socket spline (XZN), M5, 55 mm	1	51	911.1378	1/2" Bit socket Torx tamperproof, TB55	1	77	911.1574	1/2" 12 Point socket, 14 mm	1
25	911.1341	1/2" Bit socket spline (XZN), M6, 55 mm	1	52	911.1379	1/2" Bit socket Torx tamperproof, TB60	1	78	911.1575	1/2" 12 Point socket, 15 mm	1
26	911.1342	1/2" Bit socket spline (XZN), M8, 55 mm	1	53	911.1380	1/2" Bit socket Torx tamperproof, TB70	1	79	911.1576	1/2" 12 Point socket, 16 mm	1
27	911.1313	1/2" Bit socket spline (XZN), M9, 55 mm	1					80	911.1577	1/2" 12 Point socket, 17 mm	1

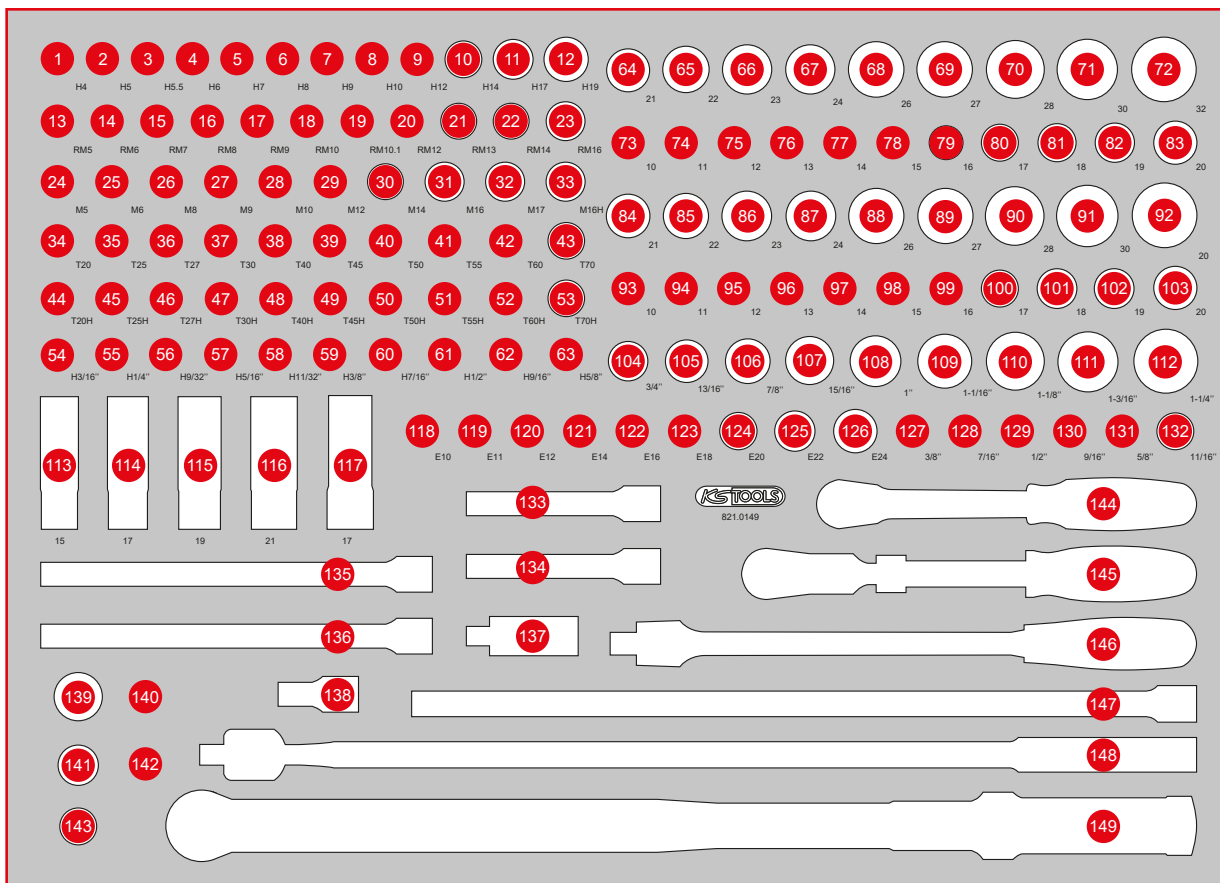

Pos.	Code	Description	pcs	Pos.	Code	Description	pcs	Pos.	Code	Description	pcs
81	911.1578	1/2" 12 Point socket, 18 mm	1	108	917.1383	1/2" 12 Point socket, 1"	1	134	911.1383	Wobble extension, 1/2", 125 mm	1
82	911.1579	1/2" 12 Point socket, 19 mm	1	109	917.1384	1/2" 12 Point socket, 1.1/16"	1	135	911.1203	1/2" Extensions, 250 mm	1
83	911.1580	1/2" 12 Point socket, 20 mm	1	110	917.1385	1/2" 12 Point socket, 1.1/8"	1	136	911.1384	Wobble extension, 1/2", 250 mm	1
84	917.1221	1/2" Hexagonal socket, 21 mm	1	111	917.1386	1/2" 12 Point socket, 1.3/16"	1	137	911.1250	1/2" Universal joint	1
85	917.1222	1/2" Hexagonal socket, 22 mm	1	112	917.1387	1/2" 12 Point socket, 1.1/4"	1	138	911.1381	Wobble extension, 1/2", 50 mm	1
86	917.1223	1/2" Hexagonal socket, 23 mm	1	113	515.0991	SlimPOWER 1/2"Alloy rim impact socket, 15 mm	1	139	911.3412	Reducing adaptor 3/4" F x 1/2" M	1
87	917.1224	1/2" Hexagonal socket, 24 mm	1	114	515.0992	SlimPOWER 1/2"Alloy rim impact socket, 17 mm	1	140	911.1233	Reducing adaptor, 1/2" F x 3/8" M	1
88	917.1343	1/2" Hexagonal socket, 26 mm	1	115	515.0993	SlimPOWER 1/2"Alloy rim impact socket, 19 mm	1	141	911.1234	Adaptor, 1/2" F x 3/4" M	1
89	917.1227	1/2" Hexagonal socket, 27 mm	1	116	515.0994	SlimPOWER 1/2"Alloy rim impact socket, 21 mm	1	142	911.3892	Adaptor, 3/8" F x 1/2" M	1
90	917.1344	1/2" Hexagonal socket, 28 mm	1	117	515.2055	Special aluminium rims special profile impact socket for Mercedes, long, 17 mm	1	143	911.1207	3/8" Sliding adaptor, 3/8" F x 1/2" M	1
91	917.1230	1/2" Hexagonal socket, 30 mm	1	118	911.4333	1/2" Torx E Socket, E10	1	144	920.1290	1/2" SlimPOWER Reversible ratchet, 72 teeth	1
92	917.1232	1/2" Hexagonal socket, 32 mm	1	119	911.4334	1/2" Torx E Socket, E11	1	145	914.1220	1/2" SlimPOWER Telescopic reversible ratchet, 72 teeth	1
93	917.1210	1/2" Hexagonal socket, 10 mm	1	120	911.4335	1/2" Torx E Socket, E12	1	146	917.1455	1/2" Flexi head drive handle	1
94	917.1211	1/2" Hexagonal socket, 11 mm	1	121	911.4336	1/2" Torx E Socket, E14	1	147	911.1836	Wobble extension, 1/2", 500 mm	1
95	917.1212	1/2" Hexagonal socket, 12 mm	1	122	911.4322	1/2" Torx E Socket, E16	1	148	918.1292	1/2" CHROMEplus Flexi head drive handle, 600 mm	1
96	917.1213	1/2" Hexagonal socket, 13 mm	1	123	911.4323	1/2" Torx E Socket, E18	1	149	516.1482	1/2" ERGOTORQUE® precision torque wrench with rotary mushroom ratchet head, 80-420Nm	1
97	917.1214	1/2" Hexagonal socket, 14 mm	1	124	911.4324	1/2" Torx E Socket, E20	1				
98	917.1215	1/2" Hexagonal socket, 15 mm	1	125	911.4325	1/2" Torx E Socket, E22	1				
99	917.1216	1/2" Hexagonal socket, 16 mm	1	126	911.4326	1/2" Torx E Socket, E24	1				
100	917.1217	1/2" Hexagonal socket, 17 mm	1	127	917.1370	1/2" 12 Point socket, 3/8"	1				
101	917.1218	1/2" Hexagonal socket, 18 mm	1	128	917.1372	1/2" 12 Point socket, 7/16"	1				
102	917.1219	1/2" Hexagonal socket, 19 mm	1	129	917.1373	1/2" 12 Point socket, 1/2"	1				
103	917.1220	1/2" Hexagonal socket, 20 mm	1	130	917.1374	1/2" 12 Point socket, 9/16"	1				
104	917.1378	1/2" 12 Point socket, 3/4"	1	131	917.1376	1/2" 12 Point socket, 5/8"	1				
105	917.1380	1/2" 12 Point socket, 13/16"	1	132	917.1377	1/2" 12 Point socket, 11/16"	1				
106	917.1381	1/2" 12 Point socket, 7/8"	1	133	911.1202	1/2" Extensions, 125 mm	1				
107	917.1382	1/2" 12 Point socket, 15/16"	1								

P 10
P 15
P 20
P 25
P 30
P 35
P 40
P 45
Individual parts S XL L M
Accessories

821.0046

XL Screwdriver set

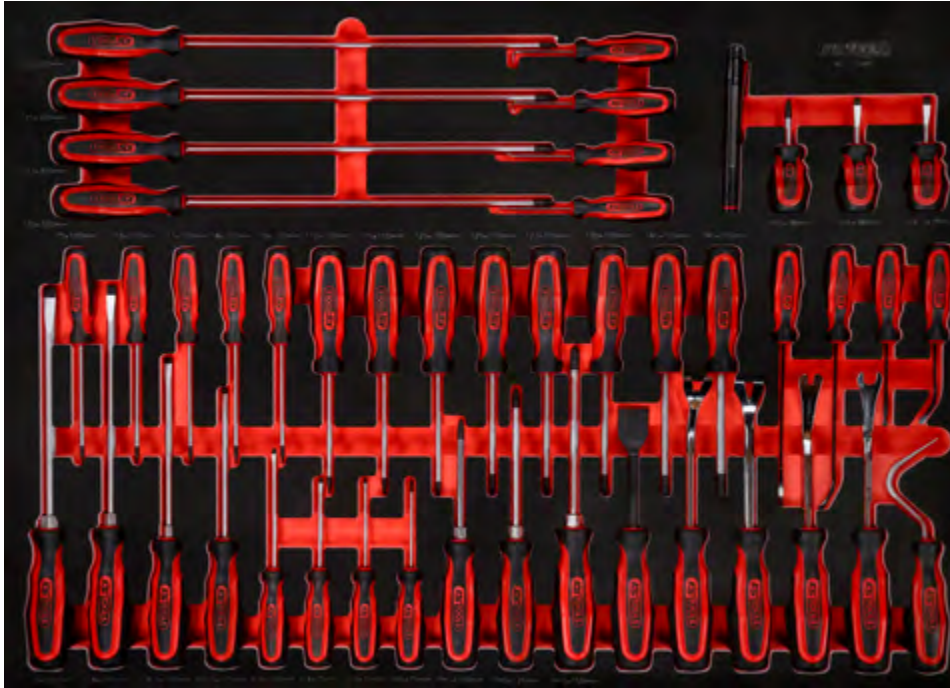

269, ^{EUR}—

46
PCS

790 x 568

P20

P30

P45

Pos.	Code	Description	pcs
1	159.1261	ERGOTORQUEplus screwdriver, Torx, T20, long	1
2	159.1262	ERGOTORQUEplus screwdriver, Torx, T25, long	1
3	159.1263	ERGOTORQUEplus screwdriver, Torx, T27, long	1
4	159.1264	ERGOTORQUEplus screwdriver, Torx, T30, long	1
5	550.1048	Hook, 90° offset	1
6	550.1049	Hook, 135° bent	1
7	550.1047	Hook, 45° offset	1

Pos.	Code	Description	pcs
8	550.1046	Hook, straight	1
9	150.4370	perfectLight torch 85 lumen	1
10	159.1026	ERGOTORQUEplus screwdriver, Torx, short, PH2	1
11	159.1001	ERGOTORQUEplus screwdriver for slotted screws, short, 6 mm	1
12	159.1123	ERGOTORQUEplus screwdriver for slotted screws, short, 6,5 mm	1
13	159.1133	ERGOTORQUEplus screwdriver, Torx, T5	1
14	159.1134	ERGOTORQUEplus screwdriver, Torx, T6	1
15	159.1135	ERGOTORQUEplus screwdriver, Torx, T7	1

Pos.	Code	Description	pcs
16	159.1030	ERGOTORQUEplus screwdriver, Torx, T8	1
17	159.1031	ERGOTORQUEplus screwdriver, Torx, T9	1
18	159.1032	ERGOTORQUEplus screwdriver, Torx, T10	1
19	159.1033	ERGOTORQUEplus screwdriver, Torx, T15	1
20	159.1034	ERGOTORQUEplus screwdriver, Torx, T20	1
21	159.1035	ERGOTORQUEplus screwdriver, Torx, T25	1
22	159.1036	ERGOTORQUEplus screwdriver, Torx, T27	1
23	159.1037	ERGOTORQUEplus screwdriver, Torx, T30	1
24	159.1038	ERGOTORQUEplus screwdriver, Torx, T40	1
25	159.1136	ERGOTORQUEplus screwdriver, Torx, T45	1

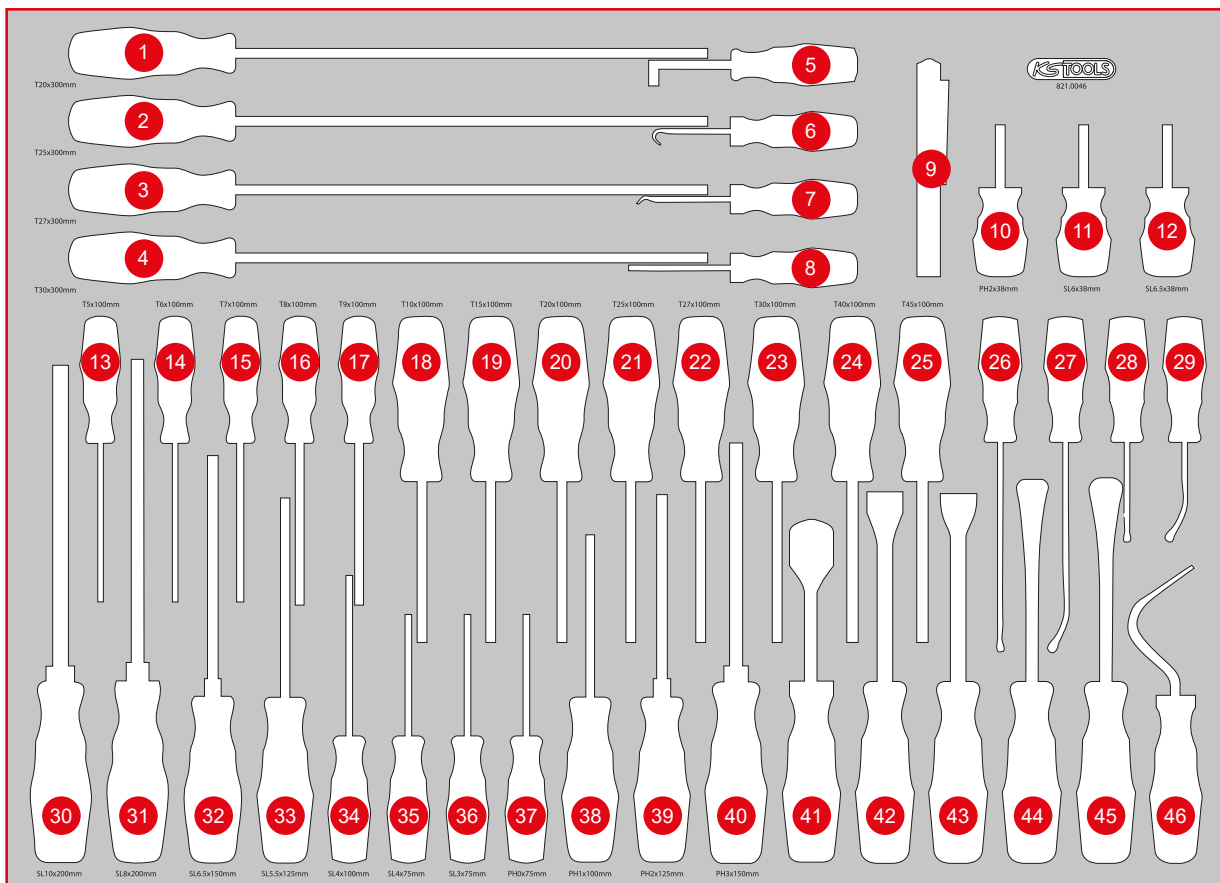

Pos.	Code	Description	pcs	Pos.	Code	Description	pcs	Pos.	Code	Description	pcs
26	140.2612	Panel lever 3 x 133 mm	1	34	159.1004	ERGOTORQUEplus screwdriver for slotted screws, 4 mm, 180 mm long	1	40	159.1024	ERGOTORQUEplus screwdriver, Torx, PH3, 265 mm	1
27	140.2614	Panel lever 3 x 133 mm, bent	1	35	159.1003	ERGOTORQUEplus screwdriver for slotted screws, 4 mm, 155 mm long	1	41	907.2232	Gasket scraper, 25 x 200 mm	1
28	140.2611	Panel lever 3 x 63 mm	1	36	159.1002	ERGOTORQUEplus screwdriver for slotted screws, 3 mm, 155 mm long	1	42	140.2616	Clip remover, short 7,5 mm	1
29	140.2613	Panel lever 3 x 63 mm, bent	1	37	159.1027	ERGOTORQUEplus screwdriver, Torx, PH0, 155 mm	1	43	140.2615	Clip remover, short 9 mm	1
30	159.1012	ERGOTORQUEplus screwdriver for slotted screws, 10 mm, 315 mm long	1	38	159.1029	ERGOTORQUEplus screwdriver, Torx, PH1, 205 mm	1	44	140.2371	Clip remover short, length 245 mm, opening 4 mm	1
31	159.1011	ERGOTORQUEplus screwdriver for slotted screws, 8 mm, 315 mm long	1	39	159.1022	ERGOTORQUEplus screwdriver, Torx, PH2, 230 mm	1	45	140.2373	Clip remover short, length 245 mm, opening 10 mm	1
32	159.1009	ERGOTORQUEplus screwdriver for slotted screws, 6,5 mm, 255 mm long	1					46	550.1073	Hook, large, sickle	1
33	159.1006	ERGOTORQUEplus screwdriver for slotted screws, 5,5 mm, 230 mm long	1								

P 10

P 15

P 20

P 25

P 30

P 35

P 40

P 45

L M

S XL

Individual parts

Accessories





**INSIGHT
IN PERFORMANCE**

821.0076

XL Screw spanner set



699, — ^{EUR}

IPCS
76

790 x 568



Pos.	Code	Description	pcs
1	517.0813	Double ring spanner, offset, 20 x 22 mm	1
2	517.0812	Double ring spanner, offset, 18 x 19 mm	1
3	517.0810	Double ring spanner, offset, 16 x 17 mm	1
4	517.0809	Double ring spanner, offset, 14 x 15 mm	1
5	517.0807	Double ring spanner, offset, 12 x 13 mm	1
6	517.0804	Double ring spanner, offset, 10 x 11 mm	1
7	517.0802	Double ring spanner, offset, 8 x 9 mm	1
8	517.0801	Double ring spanner, offset, 6 x 7 mm	1
9	518.0528	Open double ring spanner, with double joint, 10 x 11	1
10	517.0252	Open double ring spanner, offset, 8 x 10 mm	1
11	517.9244	Open double ring spanner, offset, 11 x 13 mm	1
12	517.0258	Open double ring spanner, offset, 12 x 14 mm	1
13	517.0263	Open double ring spanner, offset, 16 x 18 mm	1
14	517.0264	Open double ring spanner, offset, 17 x 19 mm	1
15	503.4619	GEARplus reversing combination ratcheting spanner, 19 mm	1

Pos.	Code	Description	pcs
16	503.4618	GEARplus reversing combination ratcheting spanner, 18 mm	1
17	503.4617	GEARplus reversing combination ratcheting spanner, 17 mm	1
18	503.4616	GEARplus reversing combination ratcheting spanner, 16 mm	1
19	503.4615	GEARplus reversing combination ratcheting spanner, 15 mm	1
20	503.4614	GEARplus reversing combination ratcheting spanner, 14 mm	1
21	503.4613	GEARplus reversing combination ratcheting spanner, 13 mm	1
22	503.4612	GEARplus reversing combination ratcheting spanner, 12 mm	1
23	503.4611	GEARplus reversing combination ratcheting spanner, 11 mm	1
24	503.4610	GEARplus reversing combination ratcheting spanner, 10 mm	1
25	503.4609	GEARplus reversing combination ratcheting spanner, 9 mm	1

Pos.	Code	Description	pcs
26	503.4608	GEARplus reversing combination ratcheting spanner, 8 mm	1
27	503.4290	GEARplus bit adaptor, 1/4" x 10 mm	1
28	503.4296	GEARplus socket adaptor, 1/4" x 10 mm	1
29	503.4297	GEARplus socket adaptor, 3/8" x 13 mm	1
30	503.4298	GEARplus socket adaptor, 1/2" x 19 mm	1
31	518.0017	CHROMEplus Combination spanner, stubby, 17 mm	1
32	518.0016	CHROMEplus Combination spanner, stubby, 16 mm	1
33	518.0015	CHROMEplus Combination spanner, stubby, 15 mm	1
34	518.0014	CHROMEplus Combination spanner, stubby, 14 mm	1
35	518.0013	CHROMEplus Combination spanner, stubby, 13 mm	1
36	518.0012	CHROMEplus Combination spanner, stubby, 12 mm	1

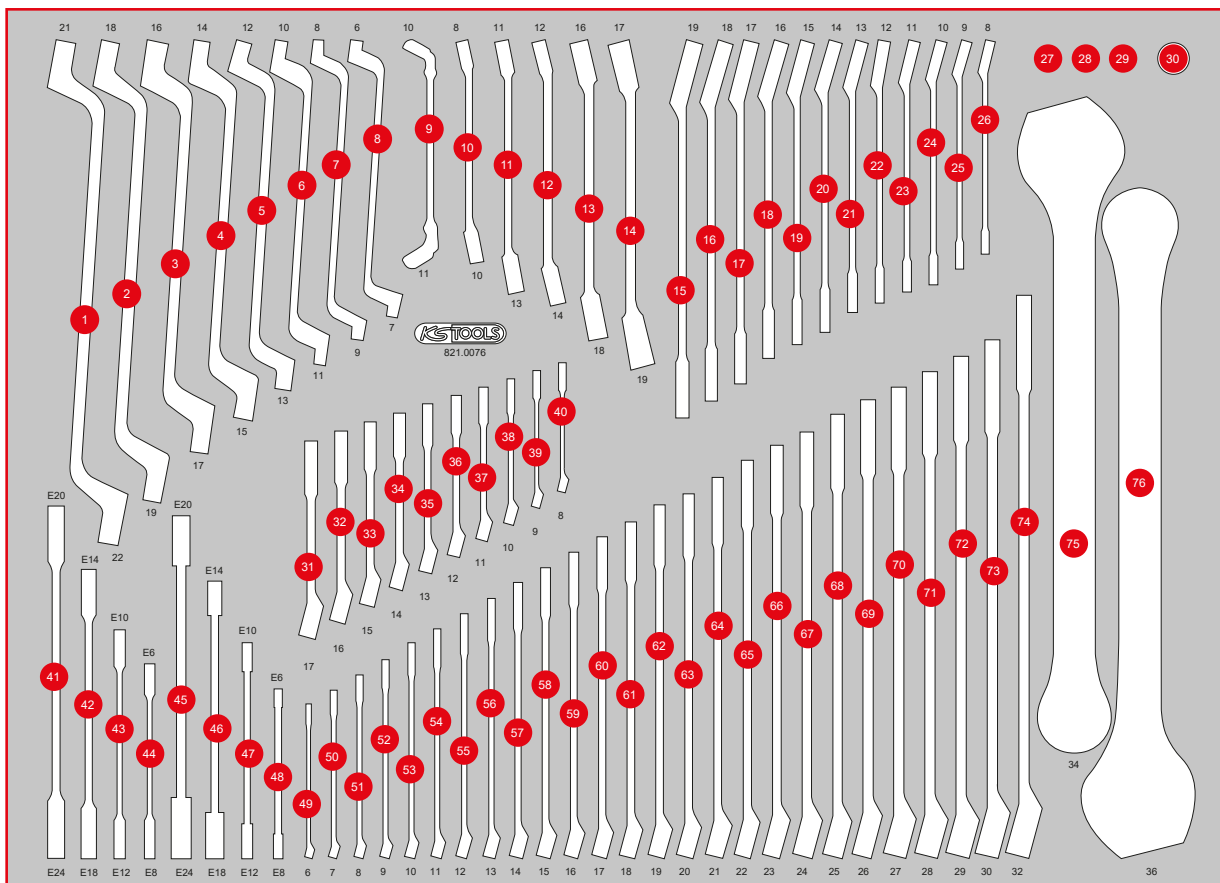

Pos.	Code	Description	pcs	Pos.	Code	Description	pcs	Pos.	Code	Description	pcs
37	518.0011	CHROMEplus Combination spanner, stubby, 11 mm	1	49	517.0606	Combination spanners, offset, 6 mm	1	66	517.0623	Combination spanners, offset, 23 mm	1
38	518.0010	CHROMEplus Combination spanner, stubby, 10 mm	1	50	517.0607	Combination spanners, offset, 7 mm	1	67	517.0624	Combination spanners, offset, 24 mm	1
39	518.0008	CHROMEplus Combination spanner, stubby, 9 mm	1	51	517.0608	Combination spanners, offset, 8 mm	1	68	517.0625	Combination spanners, offset, 25 mm	1
40	518.0007	CHROMEplus Combination spanner, stubby, 8 mm	1	52	517.0609	Combination spanners, offset, 9 mm	1	69	517.0626	Combination spanners, offset, 26 mm	1
41	503.4357	GEARplus Double ring ratchet spanner, E20 x E24	1	53	517.0610	Combination spanners, offset, 10 mm	1	70	517.0627	Combination spanners, offset, 27 mm	1
42	503.4355	GEARplus Double ring ratchet spanner, E14 x E18	1	54	517.0611	Combination spanners, offset, 11 mm	1	71	517.0628	Combination spanners, offset, 28 mm	1
43	503.4353	GEARplus Double ring ratchet spanner, E10 x E12	1	55	517.0612	Combination spanners, offset, 12 mm	1	72	517.0629	Combination spanners, offset, 29 mm	1
44	503.4351	GEARplus Double ring ratchet spanner, E6 x E8	1	56	517.0613	Combination spanners, offset, 13 mm	1	73	517.0630	Combination spanners, offset, 30 mm	1
45	911.0376	Double ring spanner for Torx E profile, E20 x E24	1	57	517.0614	Combination spanners, offset, 14 mm	1	74	517.0632	Combination spanners, offset, 32 mm	1
46	911.0374	Double ring spanner for Torx E profile, E14 x E18	1	58	517.0615	Combination spanners, offset, 15 mm	1	75	517.0634	Combination spanners, offset, 34 mm	1
47	911.0373	Double ring spanner for Torx E profile, E10 x E12	1	59	517.0616	Combination spanners, offset, 16 mm	1	76	517.0636	Combination spanners, offset, 36 mm	1
48	911.0371	Double ring spanner for Torx E profile, E6 x E8	1	60	517.0617	Combination spanners, offset, 17 mm	1				
				61	517.0618	Combination spanners, offset, 18 mm	1				
				62	517.0619	Combination spanners, offset, 19 mm	1				
				63	517.0620	Combination spanners, offset, 20 mm	1				
				64	517.0621	Combination spanners, offset, 21 mm	1				
				65	517.0622	Combination spanners, offset, 22 mm	1				

P 10
P 15
P 20
P 25
P 30
P 35
P 40
P 45
Individual parts S XL L M
Accessories

821.0034

XL Spanner set

729,-^{EUR}

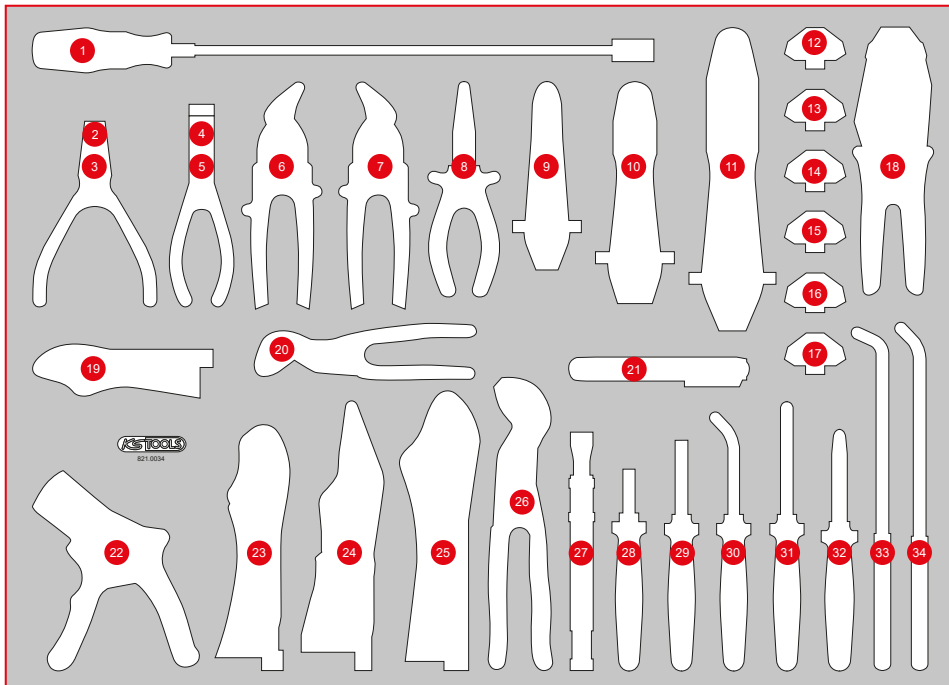

Pos.	Code	Description	pcs
1	550.1025	Flexible magnet lifter, 510mm, Øhead=15mm	1
2	500.1026	Circlip pliers for external circlips, angled, 160 mm	1
3	500.1029	Circlip pliers for external circlips, 160 mm	1
4	500.1032	Circlip pliers for internal circlips, angled, 160 mm	1
5	500.1035	Circlip pliers for internal circlips, 160 mm	1
6	118.0151	Mini metal shears, right handed cut	1
7	118.0153	Mini metal shears, left handed cut	1
8	115.1016	ERGOTORQUE flat pliers serrated, 160 mm	1
9	115.5052	Hose clamp gripper, Ø 15 mm	1
10	115.5053	Hose clamp gripper, Ø 30 mm	1
11	115.5054	Hose clamp gripper, Ø 60 mm	1
12	115.1415	Pair of crimp inserts for insulated cable lugs, Ø 0.5 - 6 mm	1
13	115.1416	Pair of crimp inserts for uninsulated cable lugs, Ø 0.5 - 10 mm	1
14	115.1417	Pair of crimp inserts for flat plugs 4.8 und 6.3 mm, Ø 0.5 - 6.0 mm	1
15	115.1418	Pair of crimp inserts for wire end ferrules, Ø 0.5 - 4 mm	1
16	115.1420	Crimp head for pin terminals	1
17	115.1421	Crimp head for non-insulated terminals	1
18	115.1401	Crimping tool	1
19	115.1031	Locking pliers, 50 mm, 140 mm	1
20	115.2011	Water pump pliers, 175 mm	1
21	150.2199	Brake fluid tester	1
22	115.1239	Self regulating wire stripper, 0,2-6 mm	1
23	115.1175	Round jaw-American type, 175 mm	1
24	115.2034	Long-nose locking pliers with quick-release lever, 45mm, L=170mm	1
25	115.1033	Self grip wrench, 220 mm	1
26	115.2010	Water pump pliers, 240 mm	1
27	115.1084	Welding self grip pliers, 195 mm	1
28	115.1012	ERGOTORQUE diagonal side cutter, 160 mm	1
29	115.1021	ERGOTORQUE combination pliers, 180 mm	1
30	115.1019	ERGOTORQUE bent nose pliers serrated, 210 mm	1
31	115.1024	ERGOTORQUE long nose pliers serrated cutter, 200 mm	1
32	115.1013	ERGOTORQUE power side cutter, 180 mm	1
33	500.7048	Sparkplug plier 12mm	1
34	500.7052	Telephone pliers 45° curved, extra long, 270mm	1



P 10

P 15

P 20

P 25

P 30

P 35

P 40

P 45

M

L

XL

S

Individual parts

Accessories

812.0005

S Spanner set

119, ^{EUR}—



268 x 398

P35

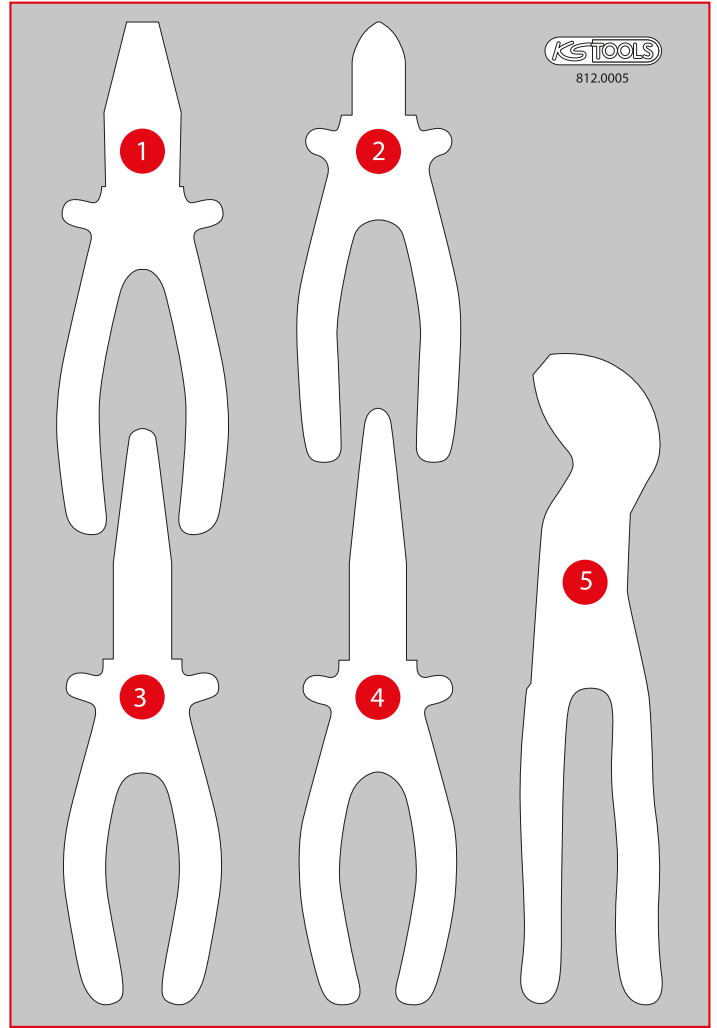

Pos.	Code	Description	pcs
1	115.1021	ERGOTORQUE combination pliers, 180 mm	1
2	115.1012	ERGOTORQUE diagonal side cutter, 160mm	1
3	115.1019	ERGOTORQUE bent nose pliers serrated, 210 mm	1
4	115.1024	ERGOTORQUE long nose pliers serrated cutter, 200 mm	1
5	115.2010	Water pump pliers, 240mm	1

812.0007

S Spanner set

139, ^{EUR}—



268 x 398

P35

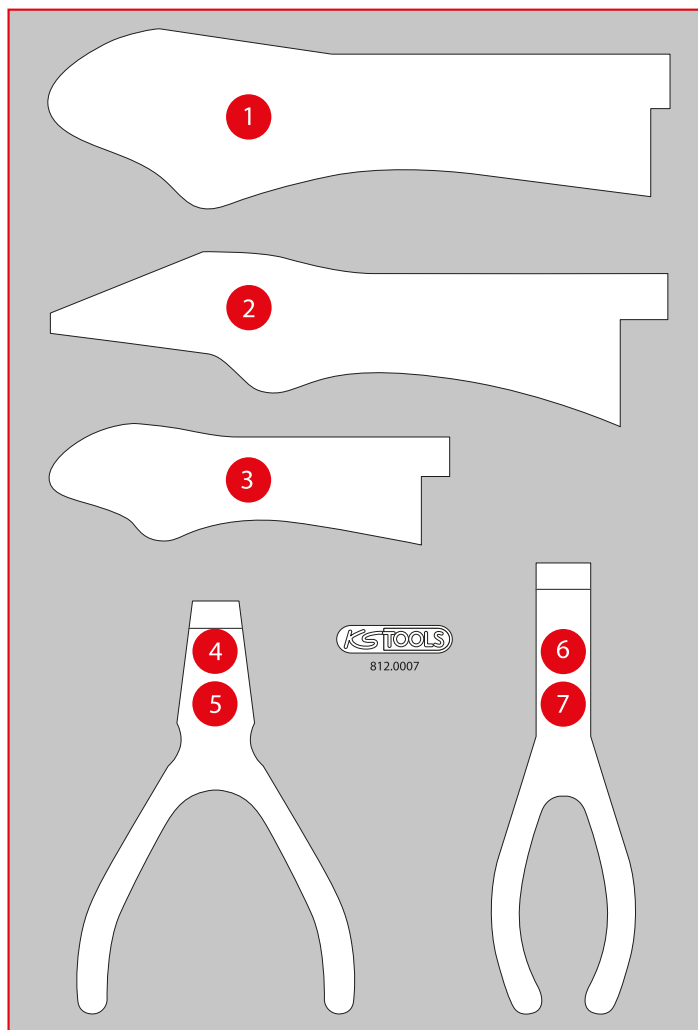

Pos.	Code	Description	pcs
1	115.1033	Locking pliers, 60mm, L = 220 mm	1
2	115.1035	Longbacken-Locking pliers, 210 mm	1
3	115.1031	Locking pliers, 50 mm, L = 140 mm	1
4	500.1029	Circlip pliers for external circlips, 160mm	1
5	500.1026	Circlip pliers for external circlips, angled, 160mm	1
6	500.1035	Circlip pliers for internal circlips, 160mm	1
7	500.1032	Circlip pliers for internal circlips, angled, 160mm	1

P 10
P 15
P 20
P 25
P 30
P 35
P 40
P 45
Individual parts S XL L M
Accessories

For the Performance Plus workshop trolleys to work, hundreds of individual parts need to work together in harmony.

In order to ensure that your workshop trolley is just as reliable in many years as it is on the day you got it, we guarantee you that every component is interchangeable.

MORE THAN THE SUM OF ITS PARTS

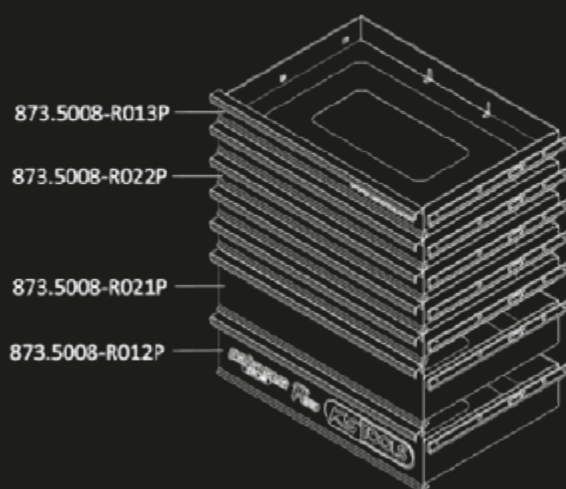

AFTERSALES WARRANTY ON ALL PARTS

Easy exchange

QUICK AVAILABILITY FOR CONTINUOUS PERFORMANCE

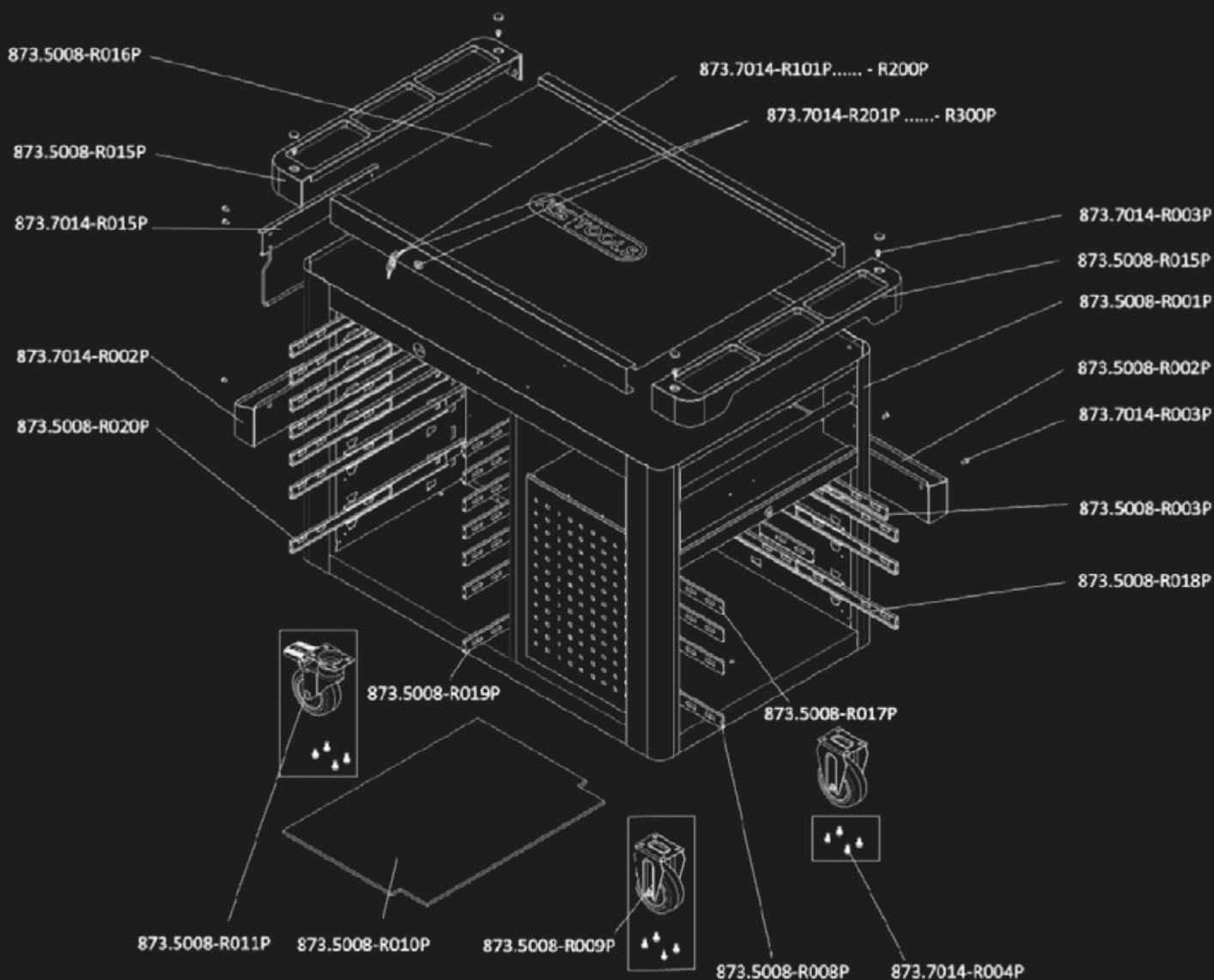

P 10

P 15

P 20

P 25

P 30

P 35

P 40

P 45

Single insoles

Individual parts

Accessories

P10

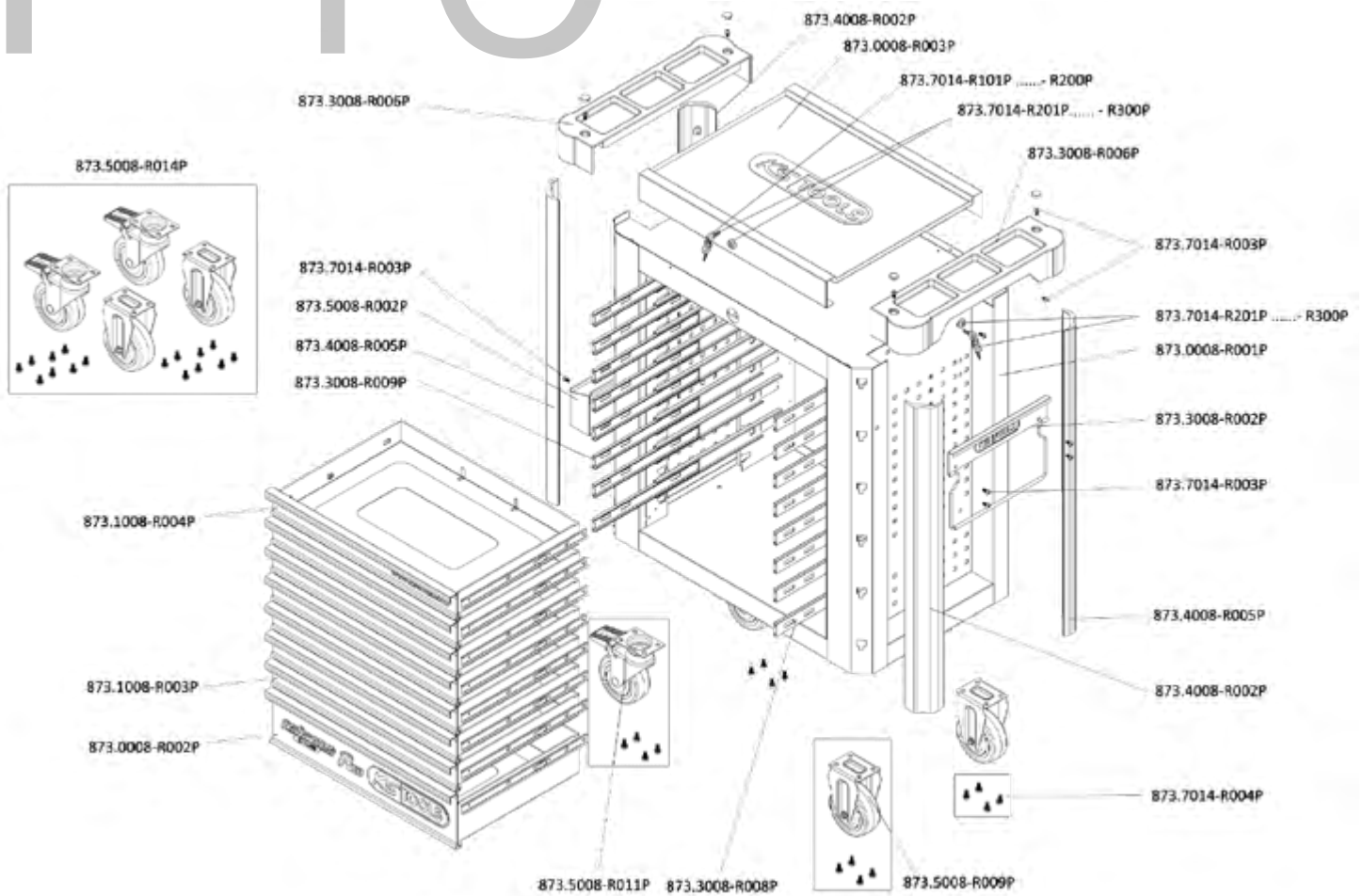

INDIVIDUAL PARTS LIST

Item No.	Description	Amount	Price per piece
873.7014-R101P...	Replacement key for PERFORMANCEplus workshop trolley lock number xyz	2	5,00 €
873.7014-R201P...	Lock with 2 keys for PERFORMANCEplus workshop trolley lock number xyz	2	9,00 €
873.0008-R001P	Body with handle	1	359,00 €
873.0008-R002P	Compartment with logo and ball-bearing guide, 568x398x154 mm	1	99,00 €
873.0008-R003P	Stainless steel worktop	1	89,00 €
873.1008-R003P	Compartment with ball-bearing guide, for workshop trolley P10/P10TC/P15, 568x398x75 mm	6	59,00 €
873.1008-R004P	Compartment with website and ball-bearing guide, for workshop trolley P10/P15, 568x398x75 mm	1	59,00 €
873.3008-R002P	Paper roll holder for PERFORMANCEplus workshop trolley	1	16,00 €
873.3008-R006P	Storage for work surface	2	24,00 €
873.3008-R008P	Full extension (with ball-bearing guide) with automatic retraction	8	24,00 €
873.3008-R009P	Full extension (with ball-bearing guide) with automatic retraction	8	24,00 €
873.4008-R002P	Plastic bumpers	2	14,00 €
873.4008-R005P	Plastic bumpers	2	14,00 €
873.5008-R002P	Can holder for PERFORMANCEplus workshop trolley	1	19,00 €
873.5008-R009P	Fixed castors for PERFORMANCEplus workshop trolley, incl. screws	2	29,00 €
873.5008-R011P	Swivel castors with brakes, for PERFORMANCEplus workshop trolley, incl. screws	2	29,00 €
873.5008-R014P	Roller set for PERFORMANCEplus workshop trolley, incl. screws	1	129,00 €
873.7014-R003P	M6x12 screws for PERFORMANCEplus workshop trolley accessories	14	0,15 €
873.7014-R004P	M8 screws for PERFORMANCEplus workshop trolley rollers (16 pcs.)	1	5,00 €



873.7014-R101P...R200P
Replacement key for lock number xyz

5, ^{EUR}



873.7014-R201P...R300P
Lock with 2 keys for lock number xyz

9, ^{EUR}



873.3008-R008P
Full extension (with ball-bearing guide) with automatic retraction, right

24, ^{EUR}



873.3008-R009P
Full extension (with ball-bearing guide) with automatic retraction, left

24, ^{EUR}



873.5008-R009P
Fixed castors, incl. screws

29, ^{EUR}



873.5008-R011P
Swivel castors with brakes, incl. screws

29, ^{EUR}



873.5008-R014P
Roller set, incl. screws

129, ^{EUR}



873.0008-R003P
Stainless steel work surface

89, ^{EUR}



873.3008-R006P
Storage for work surface, including screw cover, usable on both sides

24, ^{EUR}



873.1008-R004P
Compartment with website and ball-bearing guide, 568x398x75 mm

59, ^{EUR}



873.1008-R003P
Compartment with ball-bearing guide, 568x398x75 mm

59, ^{EUR}



873.0008-R002P
Compartment with logo and ball-bearing guide, 568x398x154 mm

99, ^{EUR}



873.5008-R002P
Can holder, 310 mm

19, ^{EUR}



873.3008-R002P
Paper roll holder, 320 mm

16, ^{EUR}



873.4008-R005P
Plastic bumpers, front left, back right

14, ^{EUR}



873.4008-R002P
Plastic bumpers, front right, back left

14, ^{EUR}



873.7014-R004P
M8 screws (16 pcs.)

5, ^{EUR}



873.7014-R003P
M6x12 screw (1 pcs.)

0,15 ^{EUR}



873.0008-R001P
Body with handle

359, ^{EUR}



A thousand great parts for tough guys!



P 10

P 15

P 20

P 25

P 30

P 35

P 40

P 45

Single insoles

Individual parts

Accessories

P10TC

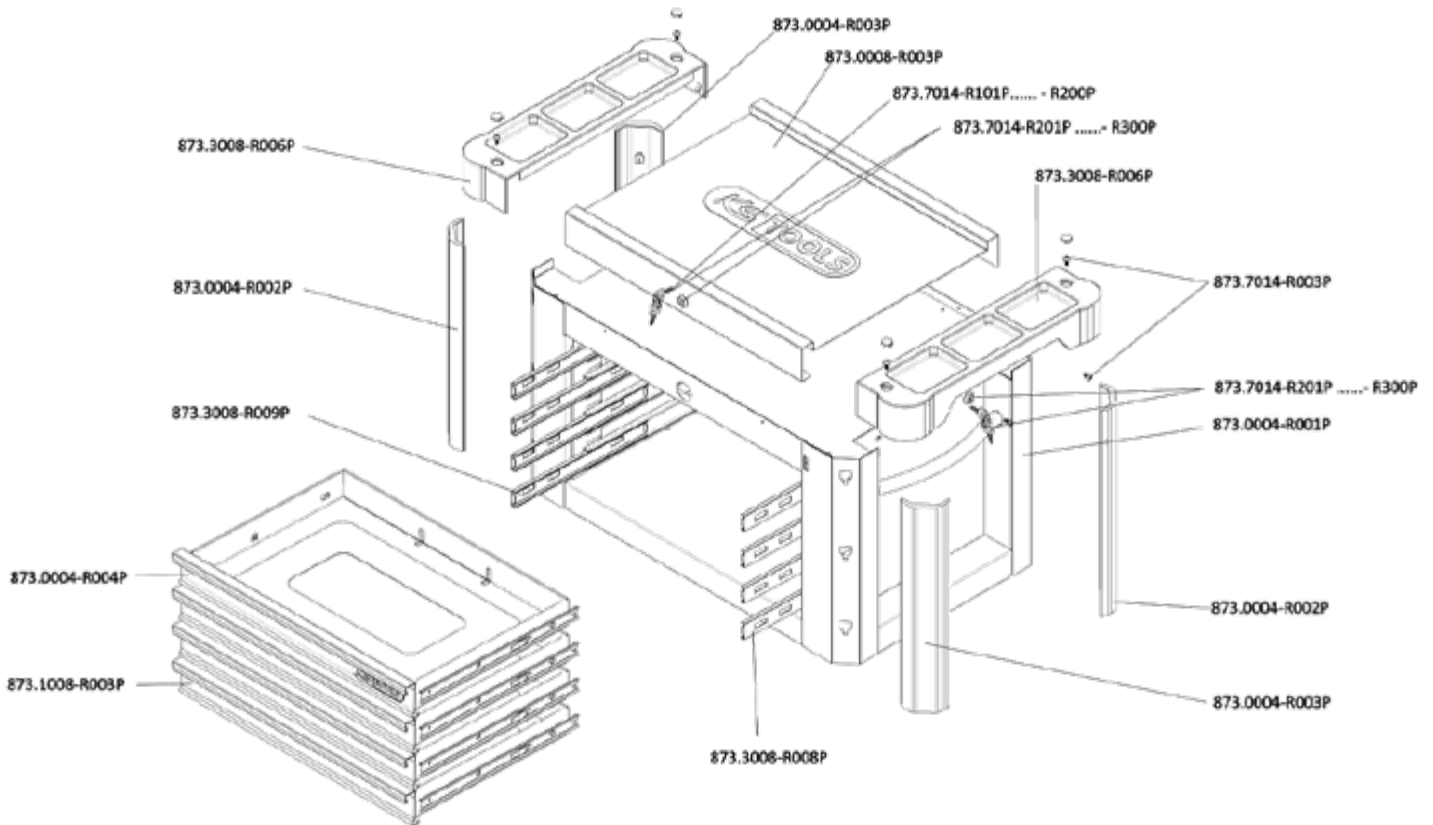

INDIVIDUAL PARTS LIST

Art.-Nr.	Description	amount	Price per piece
873.7014-R101P...	Replacement key for PERFORMANCEplus workshop trolley lock number xyz	2	5,00 €
873.7014-R201P...	Lock with 2 keys for PERFORMANCEplus workshop trolley lock number xyz	2	9,00 €
873.0004-R001P	Body of workshop trolley attachment P10TC	1	249,00 €
873.0004-R002P	Plastic bumpers for workshop trolley attachment P10TC	2	8,00 €
873.0004-R003P	Plastic bumpers for workshop trolley attachment P10TC	2	8,00 €
873.0004-R004P	Compartment with logo and ball-bearing guide, for attachment P10TC, 568x398x75 mm	1	69,00 €
873.0008-R003P	Stainless steel work surface	1	89,00 €
873.1008-R003P	Compartment with ball-bearing guide, for workshop trolley P10/P10TC/P15, 568x398x75 mm	3	59,00 €
873.3008-R006P	Storage for work surface	2	24,00 €
873.3008-R008P	Full extension (with ball-bearing guide) with automatic retraction	4	24,00 €
873.3008-R009P	Full extension (with ball-bearing guide) with automatic retraction	4	24,00 €
873.7014-R003P	M6x12 screws for PERFORMANCEplus workshop trolley accessories	8	0,15 €



5, ^{EUR}

873.7014-R101P...R200P
Replacement key for lock number xyz



9, ^{EUR}

873.7014-R201P...R300P
Lock with 2 keys, lock number xyz



24, ^{EUR}

873.3008-R008P
Full extension (with ball-bearing guide) with automatic retraction, right



24, ^{EUR}

873.3008-R009P
Full extension (with ball-bearing guide) with automatic retraction, left



89, ^{EUR}

873.0008-R003P
Stainless steel work surface



24, ^{EUR}

873.3008-R006P
Storage for work surface, including screw cover, usable on both sides



69, ^{EUR}

873.0004-R004P
Compartment with logo and ball-bearing guide, for attachment P10TC, 568x398x75 mm

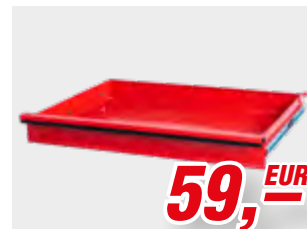

59, ^{EUR}

873.1008-R003P
Compartment with ball-bearing guide, 568x398x75 mm



8, ^{EUR}

873.0004-R002P
Plastic bumpers, front left, back right



8, ^{EUR}

873.0004-R003P
Plastic bumpers, front right, back left



0,15 ^{EUR}

873.7014-R003P
M6x12 screw (1 pcs.)



249, ^{EUR}

873.0004-R001P
Body of workshop trolley attachment

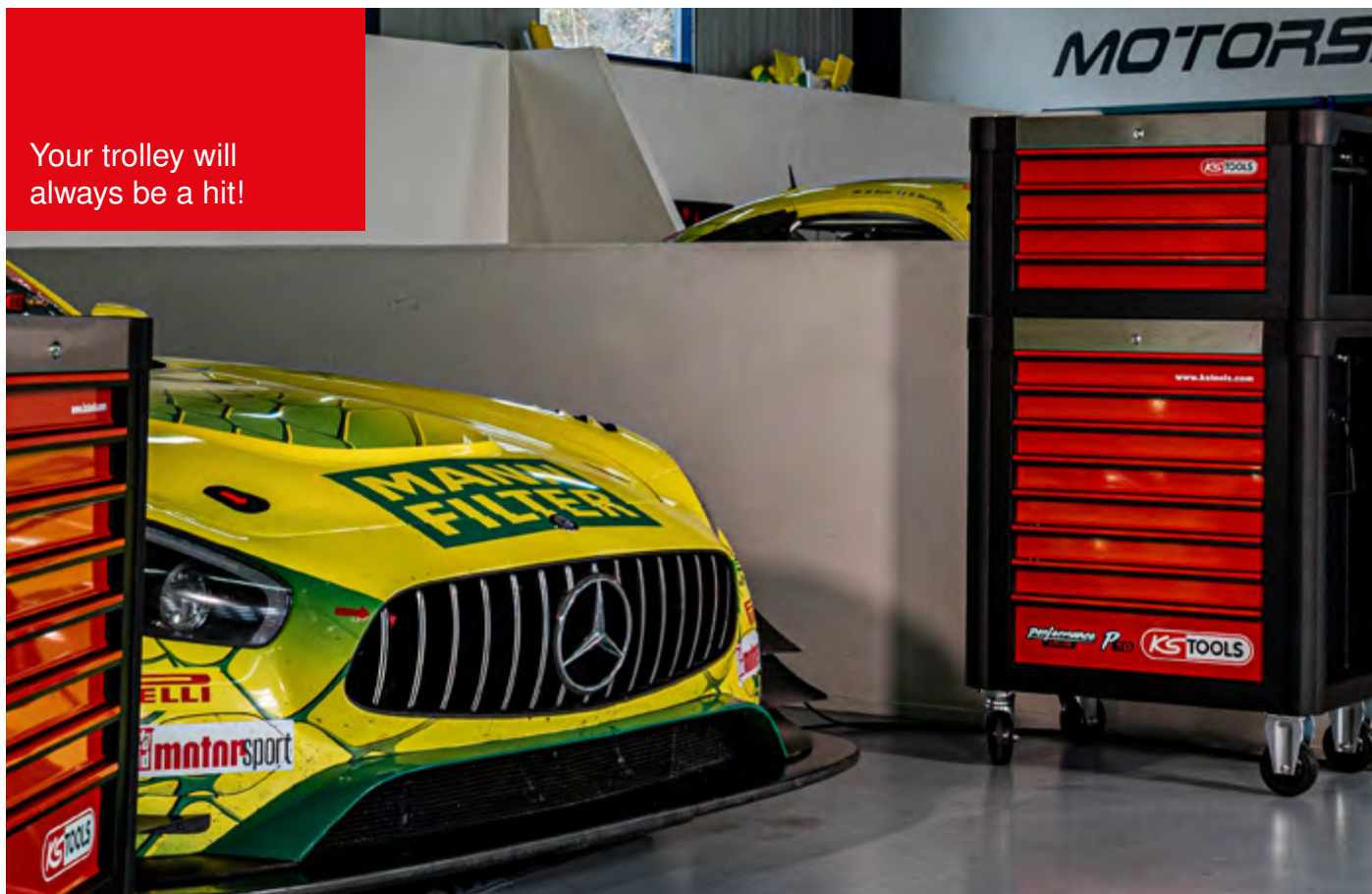

Your trolley will always be a hit!

P15

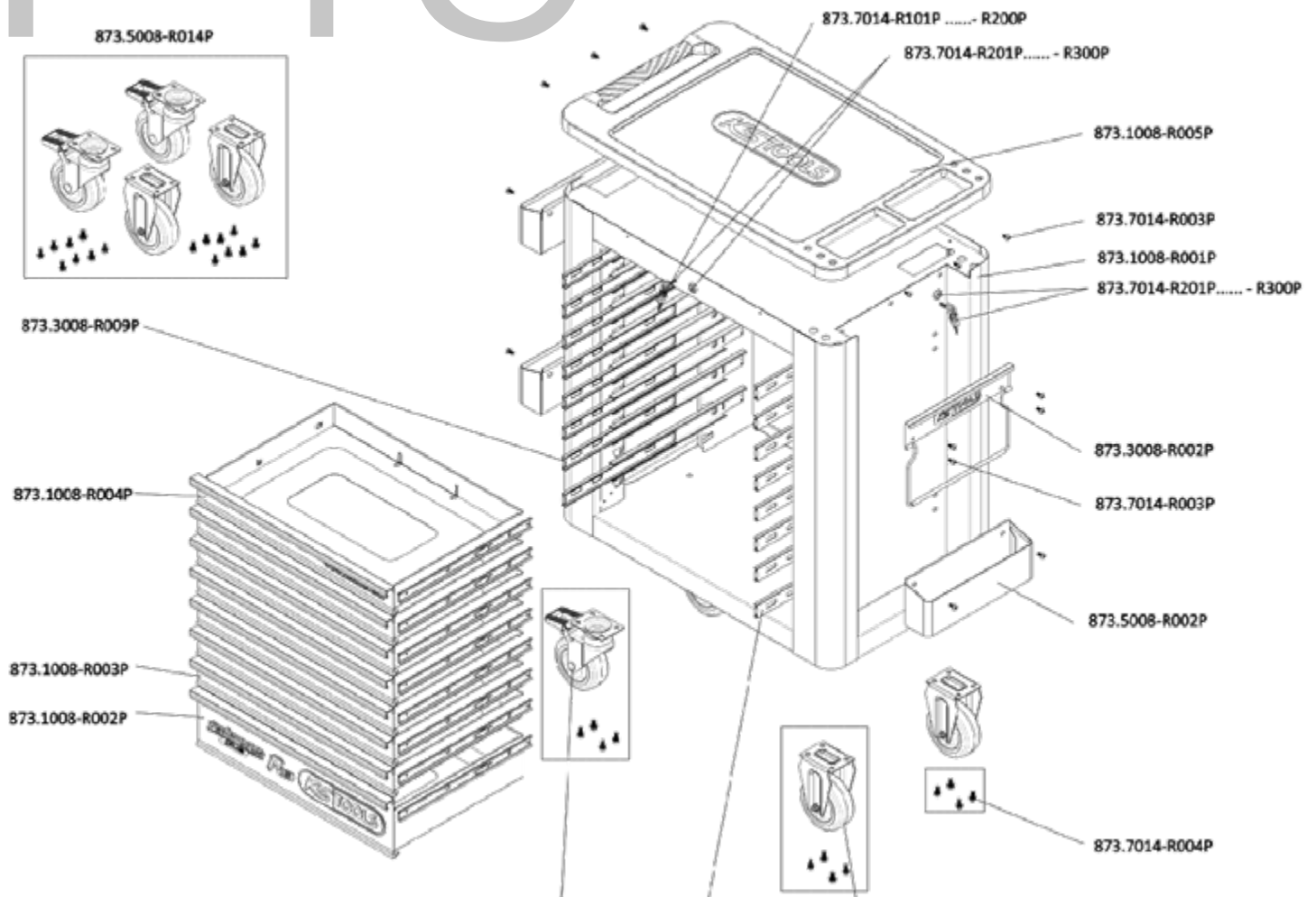

INDIVIDUAL PARTS LIST

Art.-Nr.	Description	amount	Price per piece
873.7014-R101P...	Replacement key for PERFORMANCEplus workshop trolley lock number xyz	2	5,00 €
873.7014-R201P...	Lock with 2 keys for PERFORMANCEplus workshop trolley lock number xyz	2	9,00 €
873.1008-R001P	Body of workshop trolley	1	359,00 €
873.1008-R002P	Compartment with logo and ball-bearing guide, 568x398x154 mm	1	99,00 €
873.1008-R003P	Compartment with ball-bearing guide, for workshop trolley P10/P10TC/P15, 568x398x75 mm	6	59,00 €
873.1008-R004P	Compartment with website and ball-bearing guide, for workshop trolley P10/P15, 568x398x75 mm	1	59,00 €
873.1008-R005P	Plastic work surface with handle	1	124,00 €
873.3008-R002P	Paper roll holder for PERFORMANCEplus workshop trolley P10/P15/P25	1	16,00 €
873.3008-R008P	Full extension (with ball-bearing guide) with automatic retraction	8	24,00 €
873.3008-R009P	Full extension (with ball-bearing guide) with automatic retraction	8	24,00 €
873.5008-R002P	Can holder for PERFORMANCEplus workshop trolley P10/P15/P25/P35	3	19,00 €
873.5008-R009P	Fixed castors for PERFORMANCEplus workshop trolley, incl. screws	2	29,00 €
873.5008-R011P	Swivel castors with brakes, for PERFORMANCEplus workshop trolley, incl. screws	2	29,00 €
873.5008-R014P	Roller set for PERFORMANCEplus workshop trolley, incl. screws	1	129,00 €
873.7014-R003P	M6x12 screw (1 pcs.) for PERFORMANCEplus workshop trolley accessories	16	0,15 €
873.7014-R004P	M8 screws for PERFORMANCEplus workshop trolley rollers (16 pcs.)	1	5,00 €



873.7014-R101P...R200P
Replacement key for lock number xyz

5, ^{EUR}



873.7014-R201P...R300P
Lock with 2 keys, lock number xyz

9, ^{EUR}



873.3008-R008P
Full extension (with ball-bearing guide) with automatic retraction, right

24, ^{EUR}



873.3008-R009P
Full extension (with ball-bearing guide) with automatic retraction, left

24, ^{EUR}



873.5008-R009P
Fixed castors, incl. screws

29, ^{EUR}



873.5008-R011P
Swivel castors with brakes, incl. screws

29, ^{EUR}



873.5008-R014P
Roller set, incl. screws

129, ^{EUR}



873.1008-R005P
Plastic work surface with handle

124, ^{EUR}



873.1008-R004P
Compartment with website and ball-bearing guide, 568x398x75 mm

59, ^{EUR}



873.1008-R003P
Compartment with ball-bearing guide, 568x398x75 mm

59, ^{EUR}



873.1008-R002P
Compartment with logo and ball-bearing guide, 568x398x154 mm

99, ^{EUR}



873.5008-R002P
Can holder including screws, W = 310 mm

19, ^{EUR}



873.3008-R002P
Paper roll holder including screws, W = 320 mm

16, ^{EUR}



873.7014-R004P
M8 screws (16 pcs.)

5, ^{EUR}

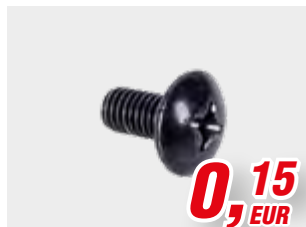

873.7014-R003P
M6x12 screw (1 pcs.)

0, ¹⁵ ^{EUR}



873.1008-R001P
Body of workshop trolley

359, ^{EUR}



The only thing that can't be replaced is the quality!

P20

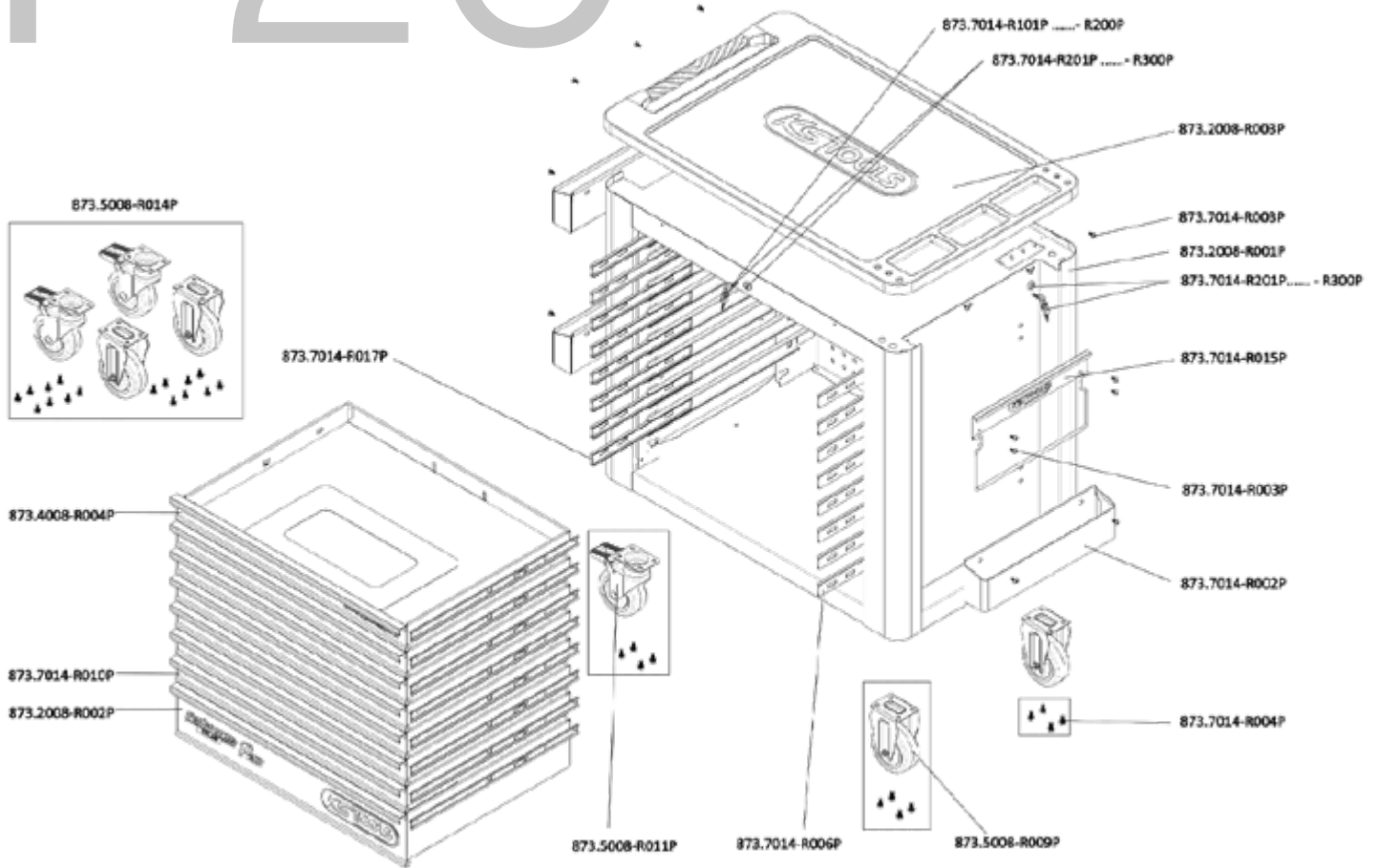

INDIVIDUAL PARTS LIST

Art.-Nr.	Description	amount	Price per piece
873.7014-R101P...	Replacement key for PERFORMANCEplus workshop trolley lock number xyz	2	5,00 €
873.7014-R201P...	Lock with 2 keys for PERFORMANCEplus workshop trolley lock number xyz	2	9,00 €
873.2008-R001P	Body of workshop trolley	1	419,00 €
873.2008-R002P	Compartment with logo and ball-bearing guide, 755x568x154 mm	1	139,00 €
873.2008-R003P	Plastic work surface with handle	1	189,00 €
873.4008-R004P	Compartment with website and ball-bearing guide, for workshop trolley P20/P30, 790x568x75 mm	1	99,00 €
873.5008-R009P	Fixed castors for PERFORMANCEplus workshop trolley, incl. screws	2	29,00 €
873.5008-R011P	Swivel castors with brakes, for PERFORMANCEplus workshop trolley, incl. screws	2	29,00 €
873.5008-R014P	Roller set for PERFORMANCEplus workshop trolley, incl. screws	1	129,00 €
873.7014-R002P	Can holder for PERFORMANCEplus workshop trolley P20/P30/P35/P40/P45	3	29,00 €
873.7014-R003P	M6x12 screw (1 pcs.) for PERFORMANCEplus workshop trolley accessories	16	0,15 €
873.7014-R004P	M8 screws for PERFORMANCEplus workshop trolley rollers (16 pcs.)	1	5,00 €
873.7014-R006P	Full extension (with ball-bearing guide) with automatic retraction	8	14,00 €
873.7014-R010P	Compartment with ball-bearing guide, for workshop trolley P20/P30/P45, 790x568x75 mm	6	79,00 €
873.7014-R015P	Paper roll holder for PERFORMANCEplus workshop trolley P20/P30/P35/P40/P45	1	19,00 €
873.7014-R017P	Full extension (with ball-bearing guide) with automatic retraction	8	14,00 €



873.7014-R101P...R200P
Replacement key for lock number xyz

5,= EUR



873.7014-R201P...R300P
Lock with 2 keys, lock number xyz

9,= EUR



873.7014-R006P
Full extension (with ball-bearing guide) with automatic retraction, right

14,= EUR



873.7014-R017P
Full extension (with ball-bearing guide) with automatic retraction, left

14,= EUR



873.5008-R009P
Fixed castors, incl. screws

29,= EUR



873.5008-R011P
Swivel castors with brakes, incl. screws

29,= EUR



873.5008-R014P
Roller set, incl. screws

129,= EUR



873.2008-R003P
Plastic work surface with handle

189,= EUR



873.4008-R004P
Compartment with website and ball-bearing guide, 790x568x75 mm

99,= EUR



873.7014-R010P
Compartment with ball-bearing guide, 790x568x75 mm

79,= EUR



873.2008-R002P
Compartment with logo and ball-bearing guide, 755x568x154 mm

139,= EUR



873.7014-R002P
Can holder including screws, W = 445 mm

29,= EUR



873.7014-R015P
Paper roll holder including screws, W = 400 mm

19,= EUR



873.7014-R004P
M8 screws (16 pcs.)

5,= EUR



873.7014-R003P
M6x12 screw (1 pcs.)

0,15 EUR



873.2008-R001P
Body of workshop trolley

419,= EUR



„Doesn't exist“
doesn't exist!

P25

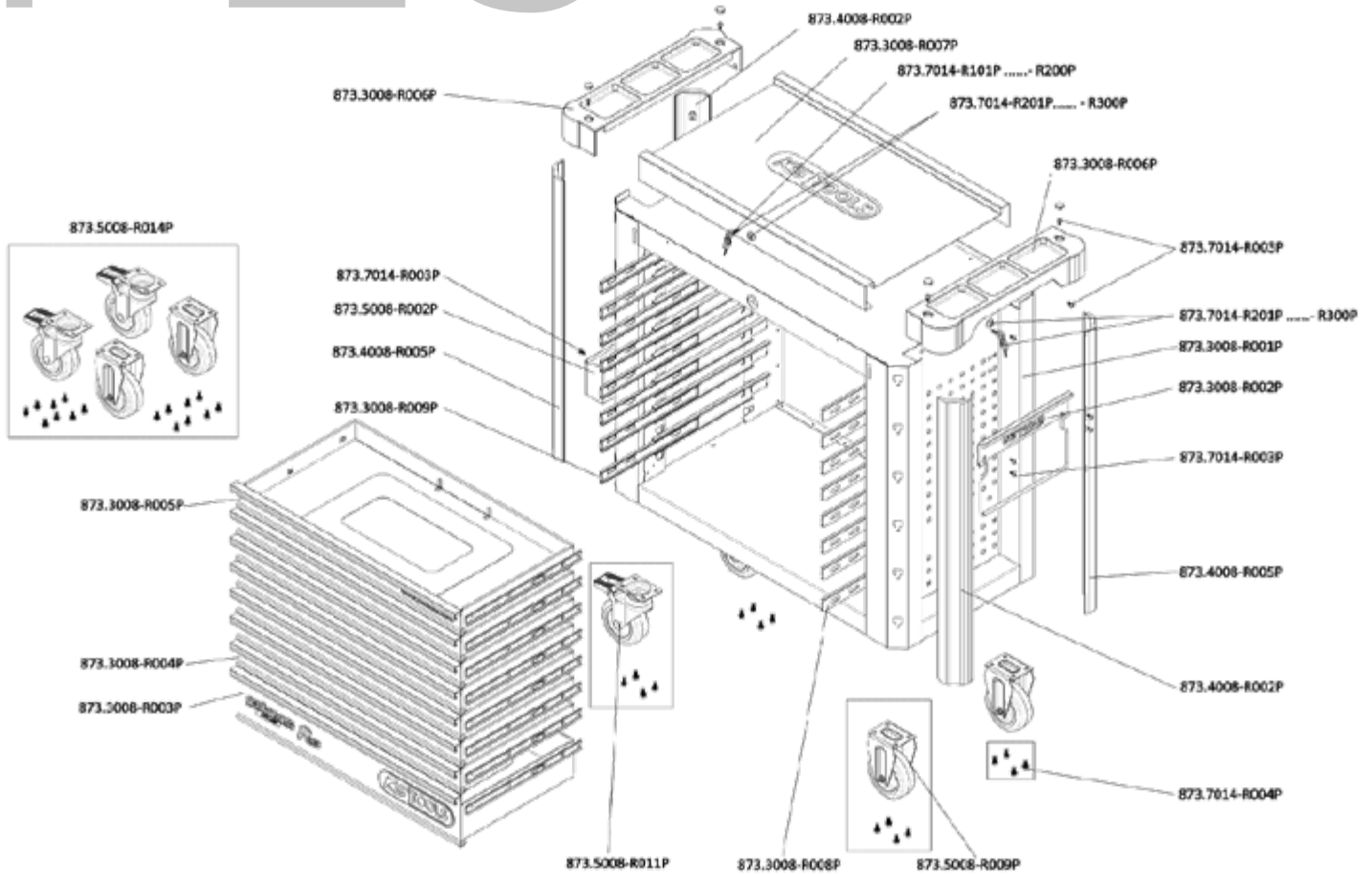

INDIVIDUAL PARTS LIST

Art.-Nr.	Description	amount	Price per piece
873.7014-R101P...	Replacement key for PERFORMANCEplus workshop trolley lock number xyz	2	5,00 €
873.7014-R201P...	Lock with 2 keys for PERFORMANCEplus workshop trolley lock number xyz	2	9,00 €
873.3008-R001P	Body with handle	1	399,00 €
873.3008-R002P	Paper roll holder for PERFORMANCEplus workshop trolley P10/P15/P25	1	16,00 €
873.3008-R003P	Compartment with logo and ball-bearing guide, 755x398x154 mm	1	119,00 €
873.3008-R004P	Compartment with ball-bearing guide, 755x398x75 mm	6	69,00 €
873.3008-R005P	Compartment with website and ball-bearing guide, 755x398x75 mm	1	69,00 €
873.3008-R006P	Storage for work surface	2	24,00 €
873.3008-R007P	Stainless steel work surface	1	109,00 €
873.3008-R008P	Full extension (with ball-bearing guide) with automatic retraction	8	24,00 €
873.3008-R009P	Full extension (with ball-bearing guide) with automatic retraction	8	24,00 €
873.4008-R002P	Plastic bumpers	2	14,00 €
873.4008-R005P	Plastic bumpers	2	14,00 €
873.5008-R002P	Can holder for PERFORMANCEplus workshop trolley P10/P15/P25/P35	1	19,00 €
873.5008-R009P	Fixed castors for PERFORMANCEplus workshop trolley, incl. screws	2	29,00 €
873.5008-R011P	Swivel castors with brakes, for PERFORMANCEplus workshop trolley, incl. screws	2	29,00 €
873.5008-R014P	Roller set for PERFORMANCEplus workshop trolley, incl. screws	1	129,00 €
873.7014-R003P	M6x12 screw (1 pcs.) for PERFORMANCEplus workshop trolley accessories	14	0,15 €
873.7014-R004P	M8 screws for PERFORMANCEplus workshop trolley rollers (16 pcs.)	1	5,00 €



873.7014-R101P...R200P
Replacement key for lock number xyz

5, ^{EUR}



873.7014-R201P...R300P
Lock with 2 keys, lock number xyz

9, ^{EUR}



873.3008-R008P
Full extension (with ball-bearing guide) with automatic retraction, right

24, ^{EUR}



873.3008-R009P
Full extension with self-closing, for drawer, left

24, ^{EUR}



873.5008-R009P
Fixed castors, incl. screws

29, ^{EUR}



873.5008-R011P
Swivel castors with brakes, incl. screws

29, ^{EUR}



873.5008-R014P
Roller set, incl. screws

129, ^{EUR}



873.3008-R007P
Stainless steel work surface

109, ^{EUR}



873.3008-R006P
Storage for work surface, including screw cover, usable on both sides

24, ^{EUR}



873.3008-R005P
Compartment with website and ball-bearing guide, 755x398x75 mm

69, ^{EUR}



873.3008-R004P
Compartment with ball-bearing guide, 755x398x75 mm

69, ^{EUR}



873.3008-R003P
Compartment with logo and ball-bearing guide, 755x398x154 mm

119, ^{EUR}



873.5008-R002P
Can holder including screws, W = 310 mm

19, ^{EUR}



873.3008-R002P
Paper roll holder including screws, W= 320 mm

16, ^{EUR}



873.4008-R005P
Plastic bumpers, front left, back right

14, ^{EUR}



873.4008-R002P
Plastic bumpers, front right, back left

14, ^{EUR}



873.7014-R004P
M8 screws (16 pcs.)

5, ^{EUR}



873.7014-R003P
M6x12 screw (1 pcs.)

0,15 ^{EUR}



873.3008-R001P
Body of workshop trolley attachment

399, ^{EUR}



Enough spares for your treasure!

P30

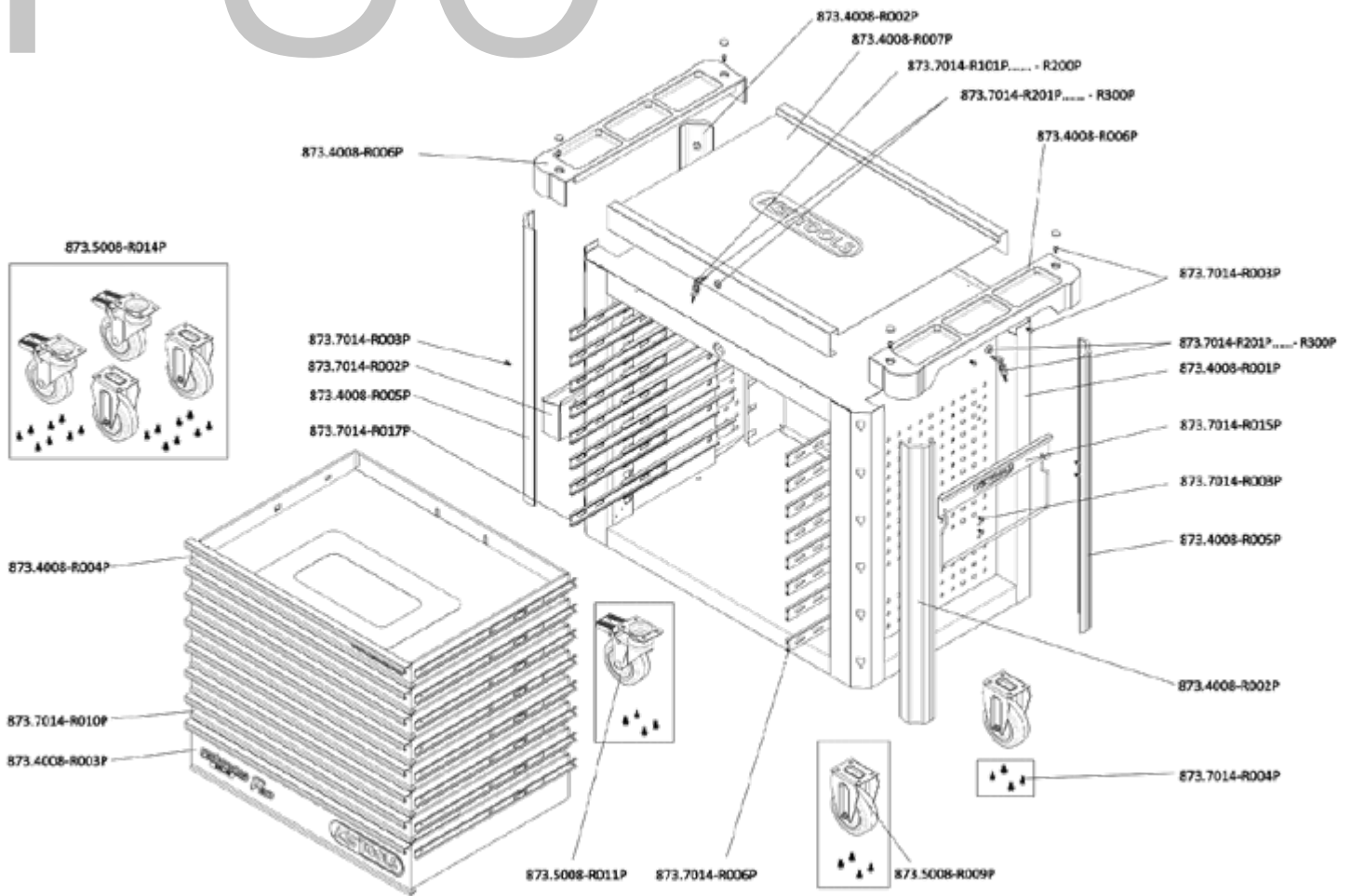

INDIVIDUAL PARTS LIST

Art.-Nr.	Description	amount	Price per piece
873.7014-R101P...	Replacement key for PERFORMANCEplus workshop trolley lock number xyz	2	5,00 €
873.7014-R201P...	Lock with 2 keys for PERFORMANCEplus workshop trolley lock number xyz	2	9,00 €
873.4008-R001P	Body with handle	1	429,00 €
873.4008-R002P	Plastic bumpers	2	14,00 €
873.4008-R003P	Compartment with logo and ball-bearing guide, 790x568x154 mm	1	139,00 €
873.4008-R004P	Compartment with website and ball-bearing guide, for workshop trolley P20/P30, 790x568x75 mm	1	99,00 €
873.4008-R005P	Plastic bumpers	2	14,00 €
873.4008-R006P	Storage for work surface	2	29,00 €
873.4008-R007P	Stainless steel work surface	1	129,00 €
873.5008-R009P	Fixed castors for PERFORMANCEplus workshop trolley, incl. screws	2	29,00 €
873.5008-R011P	Swivel castors with brakes for PERFORMANCEplus workshop trolley, incl. screws	2	29,00 €
873.5008-R014P	Roller set for PERFORMANCEplus workshop trolley, incl. screws	1	129,00 €
873.7014-R002P	Can holder for PERFORMANCEplus workshop trolley P20/P30/P35/P40/P45	1	29,00 €
873.7014-R003P	M6x12 screw (1 pcs.) for PERFORMANCEplus workshop trolley accessories	14	0,15 €
873.7014-R004P	M8 screws for PERFORMANCEplus workshop trolley rollers (16 pcs.)	1	5,00 €
873.7014-R006P	Full extension (with ball-bearing guide) with automatic retraction	8	14,00 €
873.7014-R010P	Compartment with ball-bearing guide, for workshop trolley P20/P30/P45, 790x568x75 mm	6	79,00 €
873.7014-R015P	Paper roll holder for PERFORMANCEplus workshop trolley P20/P30/P35/P40/P45	1	19,00 €
873.7014-R017P	Full extension (with ball-bearing guide) with automatic retraction	8	14,00 €



873.7014-R101P...R200P
Replacement key for lock number xyz

5, ^{EUR}



873.7014-R201P...R300P
Lock with 2 keys, lock number xyz

9, ^{EUR}



873.7014-R006P
Full extension (with ball-bearing guide) with automatic retraction, right

14, ^{EUR}



873.7014-R017P
Full extension (with ball-bearing guide) with automatic retraction, left

14, ^{EUR}



873.5008-R009P
Fixed castors, incl. screws

29, ^{EUR}



873.5008-R011P
Swivel castors with brakes, incl. screws

29, ^{EUR}



873.5008-R014P
Roller set, incl. screws

129, ^{EUR}



873.4008-R007P
Stainless steel work surface

129, ^{EUR}



873.4008-R006P
Storage for work surface, including screw cover, usable on both sides

29, ^{EUR}



873.4008-R004P
Compartment with website and ball-bearing guide, 790x568x75 mm

99, ^{EUR}



873.7014-R010P
Compartment with ball-bearing guide, 790x568x75 mm

79, ^{EUR}



873.4008-R003P
Compartment with logo and ball-bearing guide, 790x568x154 mm

139, ^{EUR}



873.7014-R002P
Can holder including screws, W = 445 mm

29, ^{EUR}



873.7014-R015P
Paper roll holder including screws, W= 400 mm

19, ^{EUR}



873.4008-R005P
Plastic bumpers, front left, back right

14, ^{EUR}



873.4008-R002P
Plastic bumpers, front right, back left

14, ^{EUR}



873.7014-R004P
M8 screws (16 pcs.)

5, ^{EUR}



873.7014-R003P
M6x12 screw (1 pcs.)

0,15 ^{EUR}



873.4008-R001P
Body of workshop trolley attachment

429, ^{EUR}



Strong parts for the great trolley!

P35

873.5008-R014P

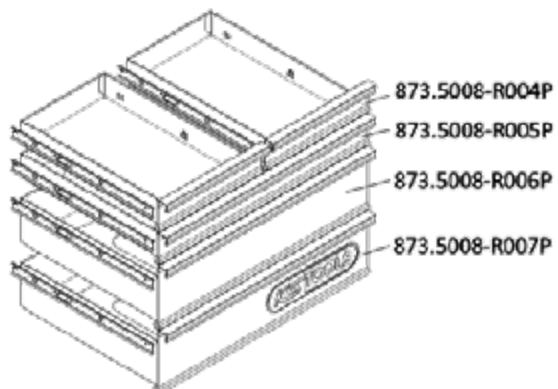
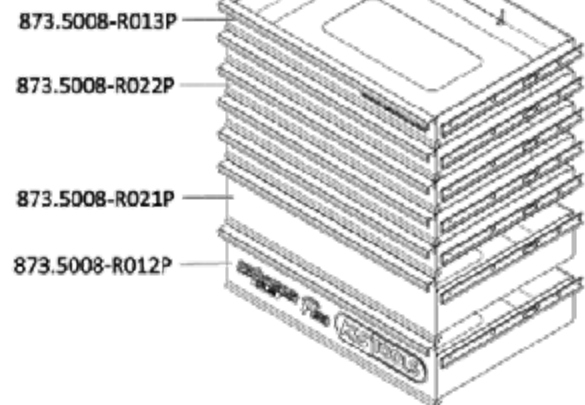
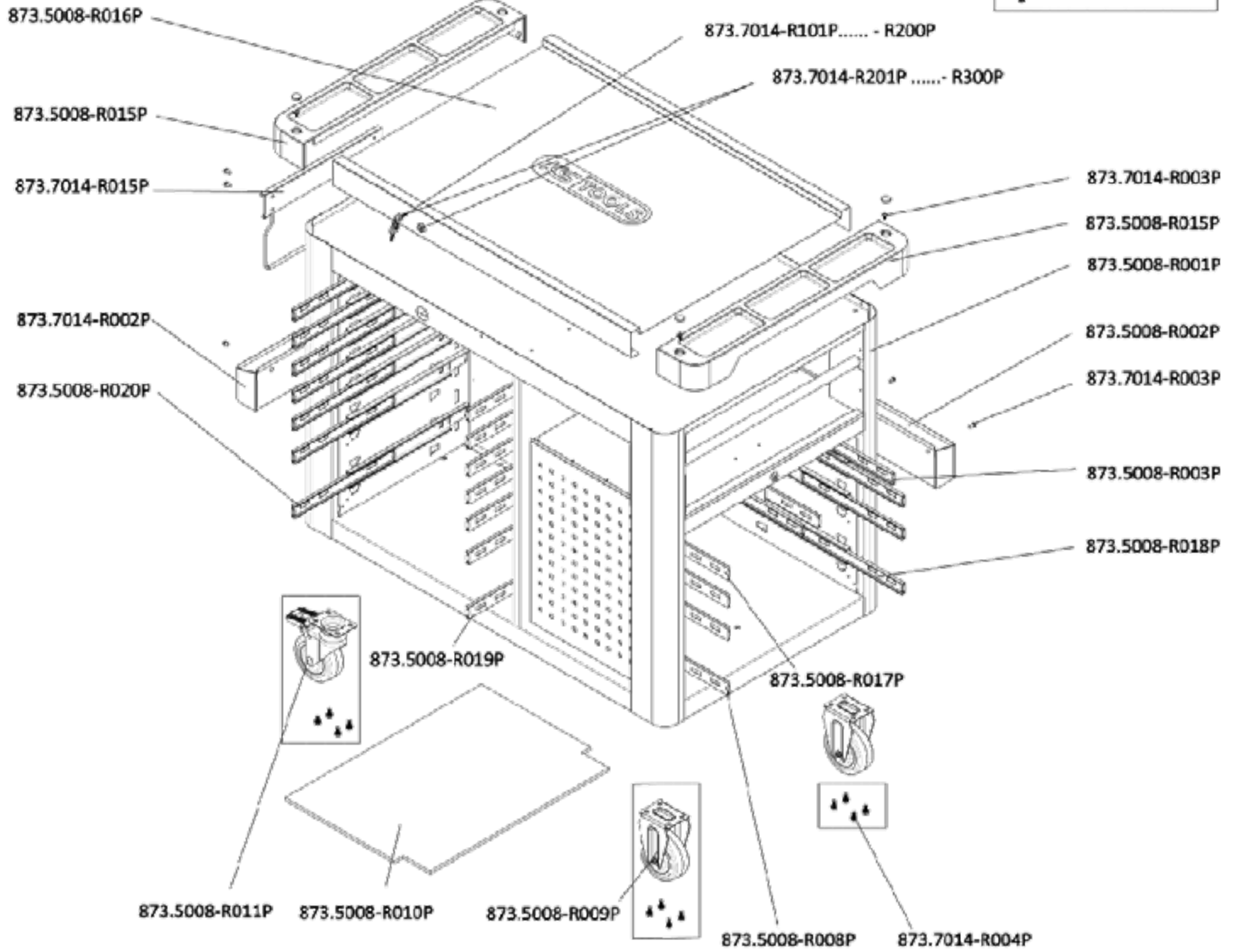
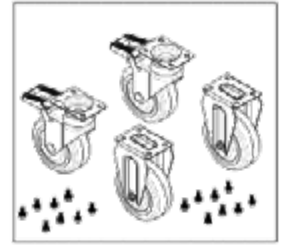



A sensational range!

INDIVIDUAL PARTS LIST

Art.-Nr.	Description	amount	Price per piece
873.7014-R101P...	Replacement key for PERFORMANCEplus workshop trolley lock number xyz	2	5,00 €
873.7014-R201P...	Lock with 2 keys for PERFORMANCEplus workshop trolley lock number xyz	2	9,00 €
873.5008-R001P	Body with handle	1	879,00 €
873.5008-R002P	Can holder for PERFORMANCEplus workshop trolley P10/P15/P25/P35	1	19,00 €
873.5008-R003P	Full extension (with ball-bearing guide) with automatic retraction	2	9,00 €
873.5008-R004P	Compartment with ball-bearing guide, 268x398x75 mm	2	49,00 €
873.5008-R005P	Compartment with ball-bearing guide, 568x398x75 mm	1	59,00 €
873.5008-R006P	Compartment with ball-bearing guide, 568x398x154 mm	1	99,00 €
873.5008-R007P	Compartment with logo and ball-bearing guide, 568x398x154 mm	1	99,00 €
873.5008-R008P	Full extension (with ball-bearing guide) with automatic retraction	3	9,00 €
873.5008-R009P	Fixed castors for PERFORMANCEplus workshop trolley, incl. screws	2	29,00 €
873.5008-R010P	Foam support	1	19,00 €
873.5008-R011P	Swivel castors with brakes, for PERFORMANCEplus workshop trolley, incl. screws	2	29,00 €
873.5008-R012P	Compartment with logo and ball-bearing guide, 568x398x154 mm	1	99,00 €
873.5008-R013P	Compartment with website and ball-bearing guide, 568x398x75 mm	1	59,00 €
873.5008-R014P	Roller set for PERFORMANCEplus workshop trolley, incl. screws	1	129,00 €
873.5008-R015P	Storage for work surface	2	34,00 €
873.5008-R016P	Stainless steel work surface	1	179,00 €
873.5008-R017P	Full extension (with ball-bearing guide) with automatic retraction	2	15,00 €
873.5008-R018P	Full extension (with ball-bearing guide) with automatic retraction	3	15,00 €
873.5008-R019P	Full extension (with ball-bearing guide) with automatic retraction	7	15,00 €
873.5008-R020P	Full extension (with ball-bearing guide) with automatic retraction	7	15,00 €
873.5008-R021P	Compartment with ball-bearing guide, 568x398x154 mm	1	99,00 €
873.5008-R022P	Compartment with ball-bearing guide, 568x398x75 mm	4	59,00 €
873.7014-R002P	Can holder for PERFORMANCEplus workshop trolley P20/P30/P35/P40/P45	1	29,00 €
873.7014-R003P	M6x12 screw (1 pcs.) for PERFORMANCEplus workshop trolley accessories	12	0,15 €
873.7014-R004P	M8 screws for PERFORMANCEplus workshop trolley rollers (16 pcs.)	1	5,00 €
873.7014-R015P	Paper roll holder for PERFORMANCEplus workshop trolley P20/P30/P35/P40/P45	1	19,00 €

P35



873.7014-R101P...R200P
Replacement key for lock number xyz

5, EUR



873.7014-R201P...R300P
Lock with 2 keys, lock number xyz

9, EUR



873.5008-R003P
Full extension (with ball-bearing guide) with automatic retraction, right

9, EUR



873.5008-R008P
Full extension with self-closing for drawer, left

9, EUR



873.5008-R019P
Full extension with self-closing for drawer, right

15, EUR



873.5008-R020P
Full extension with self-closing for drawer, left

15, EUR



873.5008-R018P
Full extension with self-closing for drawer, right

15, EUR



873.5008-R017P
Full extension with self-closing for drawer, left

15, EUR



873.5008-R009P
Fixed castors, incl. screws

29, EUR



873.5008-R011P
Swivel castors with brakes, incl. screws

29, EUR



873.5008-R014P
Roller set, incl. screws

129, EUR

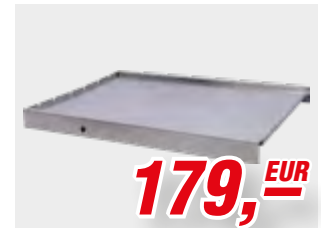

873.5008-R016P
Stainless steel work surface

179, EUR



873.5008-R010P
Foam support, 8 mm

19, EUR



873.5008-R015P
Storage for work surface, including screw cover, usable on both sides

34, EUR



873.5008-R013P
Compartment with website and ball-bearing guide, 568x398x75 mm

59, EUR



873.5008-R005P
Compartment with ball-bearing guide, 568x398x75 mm

59, EUR



P 10

P 15

P 20

P 25

P 30

P 35

P 40

P 45

Single insoles

Individual parts

Accessories



99, ^{EUR}

873.5008-R006P
Compartment with ball-bearing guide, 568x398x154 mm



99, ^{EUR}

873.5008-R012P
Compartment with logo and ball-bearing guide, 568x398x154 mm



49, ^{EUR}

873.5008-R004P
Compartment with ball-bearing guide, 268x398x75 mm



59, ^{EUR}

873.5008-R022P
Compartment with ball-bearing guide, 568x398x75 mm



99, ^{EUR}

873.5008-R021P
Compartment with ball-bearing guide, 568x398x154 mm



99, ^{EUR}

873.5008-R007P
Compartment with logo and ball-bearing guide, 568x398x154 mm



19, ^{EUR}

873.5008-R002P
Can holder including screws, W = 310 mm



29, ^{EUR}

873.7014-R002P
Can holder including screws, W = 445 mm



19, ^{EUR}

873.7014-R015P
Paper roll holder including screws, W = 400 mm



5, ^{EUR}

873.7014-R004P
M8 screws (16 pcs.)

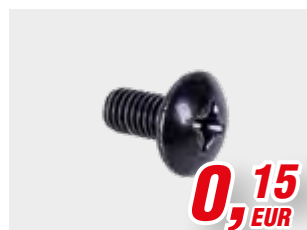

0,15 ^{EUR}

873.7014-R003P
M6x12 screw (1 pcs.)



879, ^{EUR}

873.5008-R001P
Body of workshop trolley attachment

P40

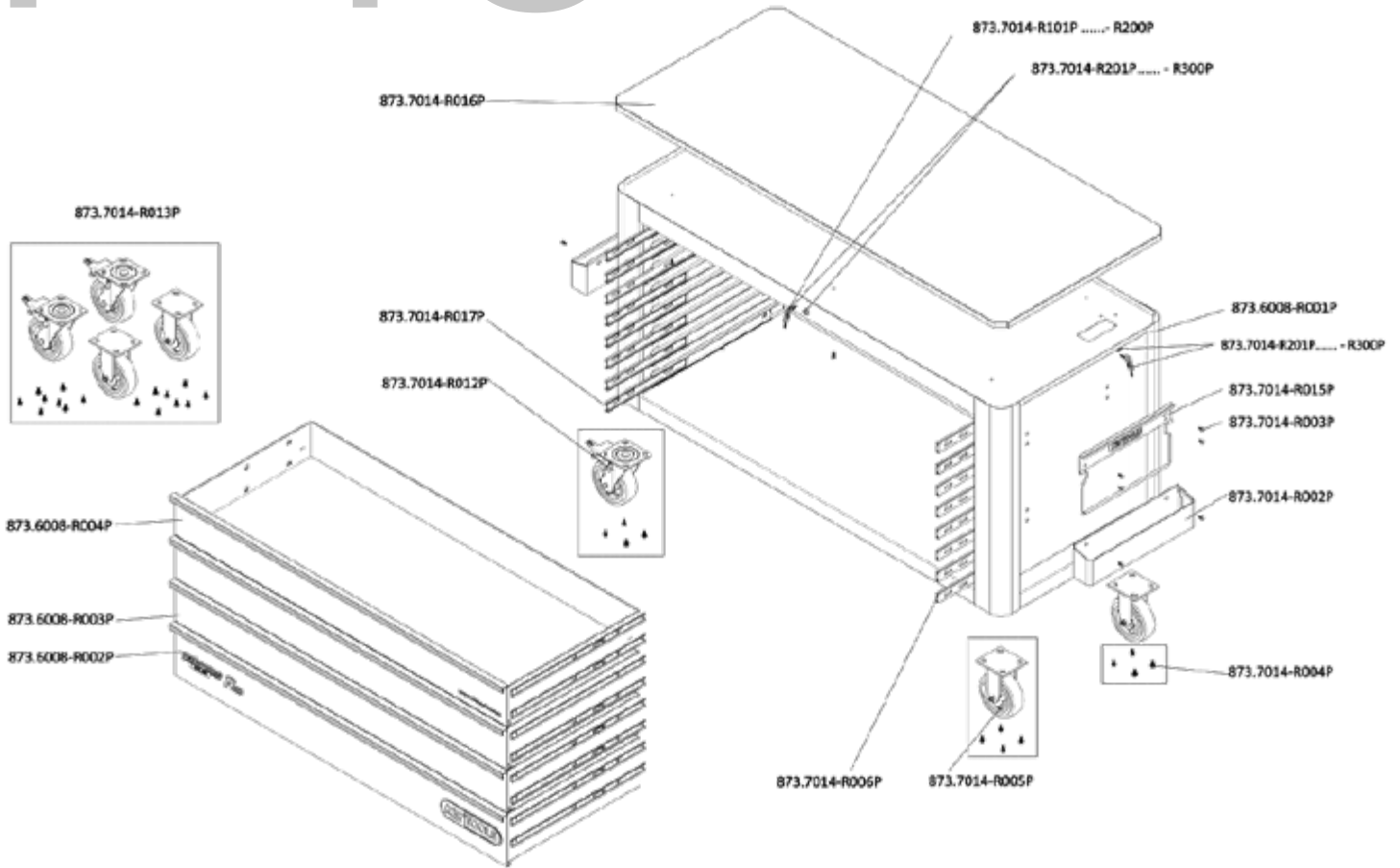

INDIVIDUAL PARTS LIST

Art.-Nr.	Description	amount	Price per piece
873.7014-R101P...	Replacement key for PERFORMANCEplus workshop trolley lock number xyz	2	5,00 €
873.7014-R201P...	Lock with 2 keys for PERFORMANCEplus workshop trolley lock number xyz	2	9,00 €
873.6008-R001P	Body with handle for workshop trolley P40	1	819,00 €
873.6008-R002P	Compartment with logo and ball-bearing guide, 1429x568x197 mm	1	269,00 €
873.6008-R003P	Compartment with ball-bearing guide, 1429x568x154 mm	2	199,00 €
873.6008-R004P	Compartment with website and ball-bearing guide, 1429x568x154 mm	1	199,00 €
873.7014-R002P	Can holder for PERFORMANCEplus workshop trolley P20/P30/P35/P40/P45	3	29,00 €
873.7014-R003P	M6x12 screw (1 pcs.) for PERFORMANCEplus workshop trolley accessories	10	0,15 €
873.7014-R004P	M8 screws for PERFORMANCEplus workshop trolley rollers (16 pcs.)	1	5,00 €
873.7014-R005P	Fixed castors for workshop trolley P45, incl. screws	2	39,00 €
873.7014-R006P	Full extension (with ball-bearing guide) with automatic retraction	8	14,00 €
873.7014-R012P	Swivel castors for workshop trolley P45, incl. screws	2	44,00 €
873.7014-R013P	Roller set for workshop trolley P45, incl. screws	1	169,00 €
873.7014-R017P	Full extension (with ball-bearing guide) with automatic retraction	8	14,00 €
873.7014-R015P	Paper roll holder for PERFORMANCEplus workshop trolley P20/P30/P35/P40/P45	1	19,00 €
873.7014-R016P	Stainless steel work surface for workshop trolley P45	1	559,00 €



873.7014-R101P...R200P
Replacement key for lock number xyz

5, ^{EUR}



873.7014-R201P...R300P
Lock with 2 keys, lock number xyz

9, ^{EUR}



873.7014-R006P
Full extension (with ball-bearing guide) with automatic retraction, right

14, ^{EUR}



873.7014-R017P
Full extension (with ball-bearing guide) with automatic retraction, left

14, ^{EUR}



873.7014-R005P
Fixed castors, incl. screws

39, ^{EUR}



873.7014-R012P
Swivel castors with brakes, incl. screws

44, ^{EUR}



873.7014-R013P
Roller set, incl. screws

169, ^{EUR}



873.7014-R016P
Stainless steel work surface

559, ^{EUR}



873.6008-R004P
Compartment with website and ball-bearing guide, 1429x568x154 mm

199, ^{EUR}



873.6008-R003P
Compartment with ball-bearing guide, 1429x568x154 mm

199, ^{EUR}



873.6008-R002P
Compartment with logo and ball-bearing guide, 1429x568x197 mm

269, ^{EUR}



873.7014-R002P
Can holder including screws, W = 445 mm

29, ^{EUR}



873.7014-R015P
Paper roll holder including screws, W = 400 mm

19, ^{EUR}



873.7014-R004P
M8 screws (16 pcs.)

5, ^{EUR}



873.7014-R003P
M6x12 screw (1 pcs.)

0,15 ^{EUR}



873.6008-R001P
Body of workshop trolley attachment

819, ^{EUR}



Always like new thanks to perfect parts!

P45

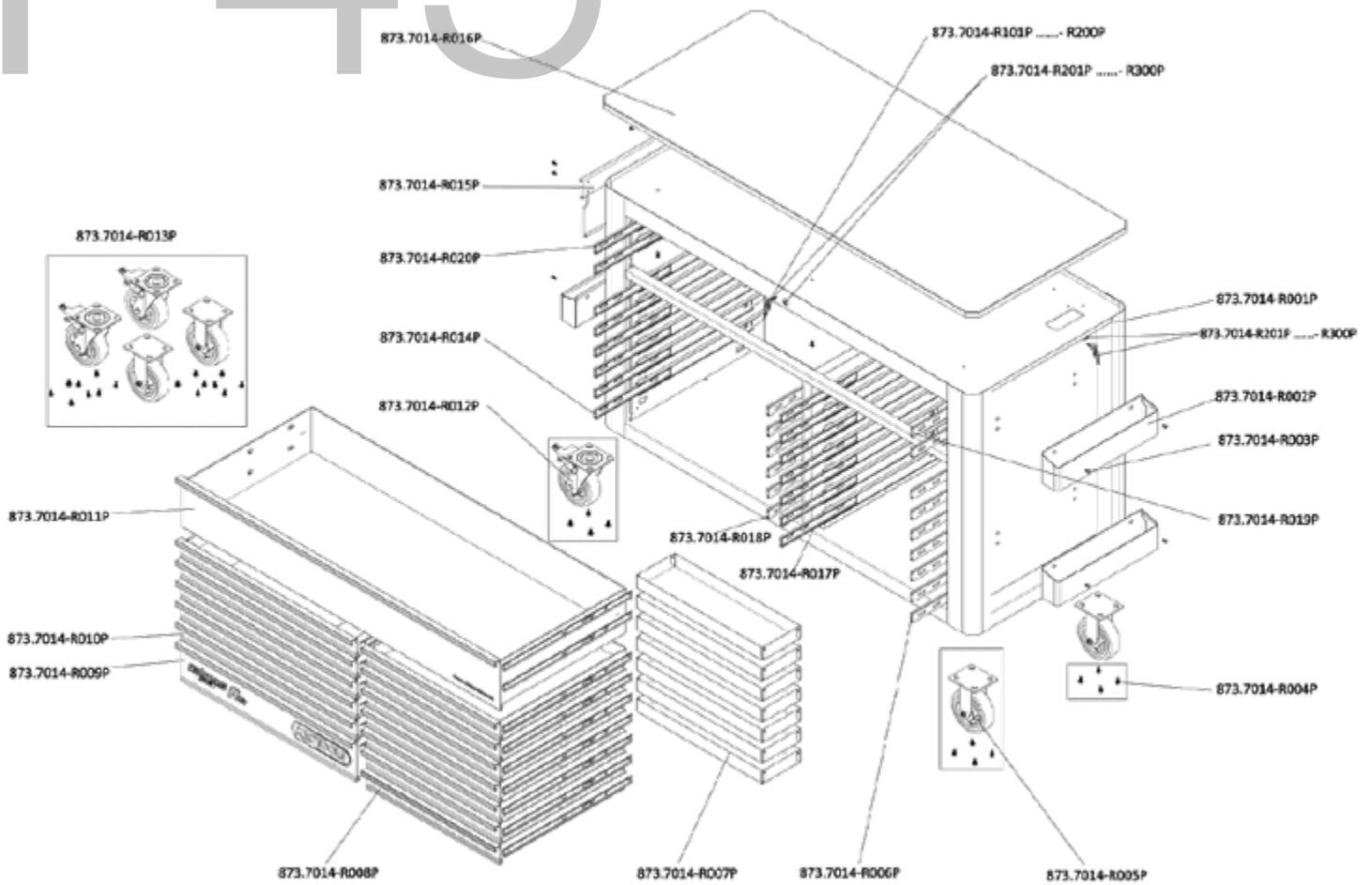

INDIVIDUAL PARTS LIST

Art.-Nr.	Description	amount	Price per piece
873.7014-R101P...	Replacement key for PERFORMANCEplus workshop trolley lock number xyz	2	5,00 €
873.7014-R201P...	Lock with 2 keys for PERFORMANCEplus workshop trolley lock number xyz	2	9,00 €
873.7014-R001P	Body with handle for workshop trolley P45	1	959,00 €
873.7014-R002P	Can holder for PERFORMANCEplus workshop trolley P20/P30/P35/P40/P45	3	29,00 €
873.7014-R003P	M6x12 screw (1 pcs.) for PERFORMANCEplus workshop trolley accessories	10	0,15 €
873.7014-R004P	M8 screws for PERFORMANCEplus workshop trolley rollers (16 pcs.)	1	5,00 €
873.7014-R005P	Fixed castors for workshop trolley P45, incl. screws	2	39,00 €
873.7014-R006P	Full extension (with ball-bearing guide) with automatic retraction	7	14,00 €
873.7014-R007P	Storage for compartments for workshop trolley P45	7	15,00 €
873.7014-R008P	Compartment with ball-bearing guide, 568x568x75 mm	7	69,00 €
873.7014-R009P	Compartment with logo and ball-bearing guide, 790x568x154 mm	1	139,00 €
873.7014-R010P	Compartment with ball-bearing guide, for workshop trolley P20/P30/P45, 790x568x75 mm	5	79,00 €
873.7014-R011P	Compartment with website and ball-bearing guide, 1429x568x197 mm	1	199,00 €
873.7014-R012P	Swivel castors for workshop trolley P45, incl. screws	2	44,00 €
873.7014-R013P	Roller set for workshop trolley P45, incl. screws	1	169,00 €
873.7014-R014P	Full extension (with ball-bearing guide) with automatic retraction	6	14,00 €
873.7014-R015P	Paper roll holder for PERFORMANCEplus workshop trolley P20/P30/P35/P40/P45	1	19,00 €
873.7014-R016P	Stainless steel work surface for workshop trolley P45	1	559,00 €
873.7014-R017P	Full extension (with ball-bearing guide) with automatic retraction	7	14,00 €
873.7014-R018P	Full extension (with ball-bearing guide) with automatic retraction	6	14,00 €
873.7014-R019P	Full extension (with ball-bearing guide) with automatic retraction	2	14,00 €
873.7014-R020P	Full extension (with ball-bearing guide) with automatic retraction	2	14,00 €



873.7014-R101P...R200P
Replacement key for lock number xyz

5, ^{EUR}



873.7014-R201P...R300P
Lock with 2 keys, lock number xyz

9, ^{EUR}



873.7014-R006P
Full extension (with ball-bearing guide) with automatic retraction, right

14, ^{EUR}



873.7014-R014P
Full extension (with ball-bearing guide) with automatic retraction, left

14, ^{EUR}



873.7014-R017P
Full extension (with ball-bearing guide) with automatic retraction, left

14, ^{EUR}



873.7014-R018P
Full extension with self-closing for drawer, right

14, ^{EUR}



873.7014-R019P
Full extension (with ball-bearing guide) with automatic retraction, right

14, ^{EUR}



873.7014-R020P
Full extension with self-closing for drawer, left

14, ^{EUR}



873.7014-R005P
Fixed castors, incl. screws

39, ^{EUR}



873.7014-R012P
Swivel castors with brakes, incl. screws

44, ^{EUR}



873.7014-R013P
Roller set, incl. screws

169, ^{EUR}



873.7014-R016P
Stainless steel work surface

559, ^{EUR}



873.7014-R011P
Compartment with website and ball-bearing guide, 1429x568x197 mm

199, ^{EUR}



873.7014-R008P
Compartment with ball-bearing guide, 568x568x75 mm

69, ^{EUR}



873.7014-R010P
Compartment with ball-bearing guide, 790x568x75 mm

79, ^{EUR}



873.7014-R009P
Compartment with logo and ball-bearing guide, 790x568x154 mm

139, ^{EUR}



873.7014-R007P
Storage for compartments

15, ^{EUR}



873.7014-R002P
Can holder including screws, W = 445 mm

29, ^{EUR}



873.7014-R015P
Paper roll holder including screws, W= 400 mm

19, ^{EUR}



873.7014-R004P
M8 screws (16 pcs.)

5, ^{EUR}

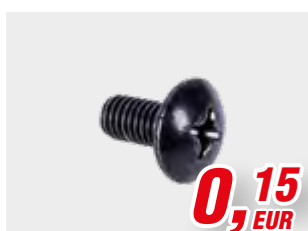

873.7014-R003P
M6x12 screw (1 pcs.)

0,15 ^{EUR}



873.7014-R001P
Body of workshop trolley attachment

959, ^{EUR}



EACH TROLLEY IS UNIQUE

**Tool holders, pipe holders, storage shelves,
magnetic shells, clamps, holders and hooks:
The extensive range of accessories for
Performance Plus fulfils every wish and turns
your workshop trolley into your personal
one-of-a-kind piece. Extend your performance!**

**FREELY CONFIGURABLE –
EVEN AFTER PURCHASING**

**Fully tailored
to your needs**

**HOLDERS FOR ALL
TYPES OF TOOLS**



860.0855
Pipe holder, Ø 60mm

4,=
EUR



860.0856
Pipe holder, Ø 100mm

6,50
EUR



860.0857
Storage shelf without partition,
350x125mm

19,=
EUR



860.0858
Storage shelf without partition,
450x150mm

25,=
EUR



860.0859
Lin bin holder single, size 7+8

3,=
EUR



860.0870
Universal tool holder self drill,
390x45mm

16,=
EUR



860.0871
Universal tool storage box,
55x310x125mm

31,=
EUR



860.0878
Sheet steel tray, 435x250mm

34,=
EUR



860.0873
Socket holder, 9 holes, 390x30mm

18,=
EUR



860.0879
Paper roll holder, 355mm

18,=
EUR



860.0880
Document holder, 220x310mm

15,=
EUR



860.0881
Works order holder, 220x310mm

19,=
EUR



860.0882
Magnet set, Ø 25mm, red, pack
of 10

16,=
EUR



860.0883
Magnet set, Ø 25mm, green, pack
of 10

16,=
EUR

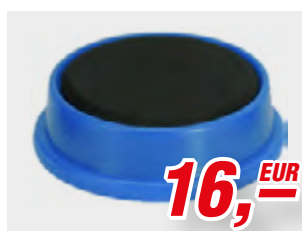

860.0884
Magnet set, Ø 25mm, blue, pack
of 10

16,=
EUR



860.0886
Drill holder for MK 2 and MK 3
shafts, 16 holes

18,=
EUR



860.0887
Bit holde, 7 holes, 150x35mm

8,=
EUR



860.0872
Hexagon socket holder, 11 holes,
145x70mm

9,=
EUR



860.0894
Socket holder for 1/2" sockets, 6
holes

24,=
EUR



860.0895
Socket holder for 1/2" sockets, 13
holes

26,=
EUR

ACCESSORIES

- Accessories suitable for hole measurements
10 x 10 mm – hole distance 38 mm
- fixing screws included
- baseplate thickness 1.5 mm
- galvanised steel plate



860.0801
Tool holder with straight end Ø
6mm, 50mm



860.0802
Tool holder with straight end Ø
6mm, 100mm



860.0803
Tool holder with straight end Ø
6mm, 150mm



860.0820
Double tool holder with straight end
Ø 6mm, 35mm



860.0821
Double tool holder with straight end
Ø 6mm, 50mm

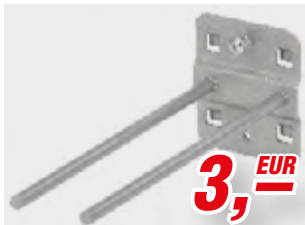

860.0822
Double tool holder with straight end
Ø 6mm, 75mm



860.0804
Tool holder with angled hook end Ø
6mm, 50mm



860.0805
Tool holder with angled hook end Ø
6mm, 100mm



860.0806
Tool holder with angled hook end Ø
6mm, 150mm



860.0807
Tool holder with angled hook end Ø
6mm, 200mm



860.0812
Double tool holder with angled hook
end, Ø 6 mm, 35mm



860.0813
Double tool holder with angled hook
end, Ø 6 mm, 50mm



860.0814
Double tool holder with angled hook
end, Ø 6 mm, 75mm



860.0815
Double tool holder with angled hook
end, Ø 6 mm, 150mm



860.0809
Tool holder with vertical hook end Ø
6mm, 35mm



860.0810
Tool holder with vertical hook end Ø
6mm, 75mm



860.0811
Tool holder with vertical hook end Ø
6mm, 125mm

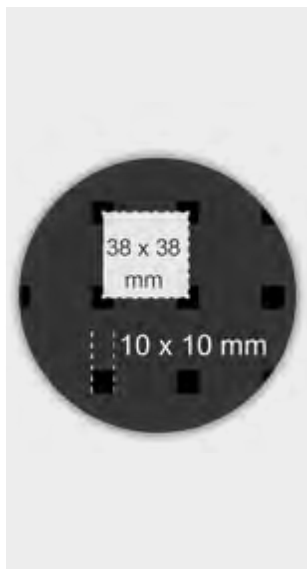

860.0816
Double tool holder with vertical hook end, Ø 6 mm, 35mm



860.0817
Double tool holder with vertical hook end, Ø 6 mm, 50mm



860.0818
Double tool holder with vertical hook end, Ø 6 mm, 75mm



860.0819
Double tool holder with vertical hook end, Ø 6 mm, 150mm



860.0824
Tool clip, single small, Ø 6mm



860.0825
Tool clip, single small, Ø 10mm



860.0826
Tool clip, single small, Ø 13mm



860.0827
Tool clip, single small, Ø 16mm



860.0828
Tool clip, single small, Ø 19mm



860.0829
Tool clip, double small, Ø 6mm



860.0830
Tool clip, double small, Ø 10mm



860.0831
Tool clip, double small, Ø 13mm



860.0832
Tool clip, double small, Ø 16mm



860.0833
Tool clip, double small, Ø 19mm



860.0834
Tool clip, single large, 25mm



860.0835
Tool clip, single large, 28mm

ACCESSORIES



860.0836
Tool clip, single large, 32mm

2,50
EUR



860.0823
Angled hook for nuts and sockets
Ø 6mm

1,50
EUR



860.0837
Pliers holder depth 20mm, 35mm

2,-
EUR



860.0838
Pliers holder depth 20mm, 55mm

2,-
EUR



860.0839
Pliers holder depth 20mm, 75mm

3,-
EUR



860.0840
Round holder, 25x65mm

2,50
EUR



860.0841
Power tool holder, Ø 40mm

2,50
EUR



860.0842
Power tool holder, Ø 60mm

3,-
EUR



860.0843
Power tool holder, Ø 80mm

3,50
EUR



860.0844
Tool holder 3 way, Ø 6mm, 150mm

3,-
EUR



860.0874
Cable holder, 150mm

4,50
EUR



860.0875
Cable holder, 200mm

4,50
EUR

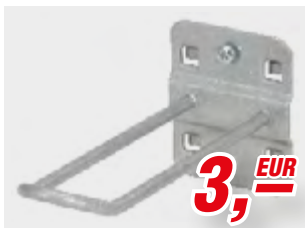

860.0876
Tool holder for euro blister
packaging, 125mm

3,-
EUR

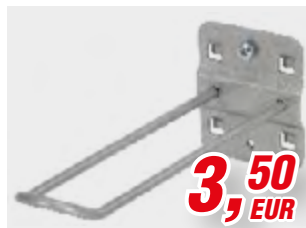

860.0877
Tool holder for euro blister
packaging, 150mm

3,50
EUR



860.0845
Six way tool holder hook ends 45°
angled

7,50
EUR



860.0860
Base plate, small

1,50
EUR



860.0861
Base plate, large

2,-
EUR



860.0862
Lin bin holder, 550x40mm

13,-
EUR



860.0863
Lin bin holder, 550x60mm

**14,,-
EUR**



860.0864
Spanner holder tapered for 10 spanners, 145mm

**11,,-
EUR**



860.0865
Spanner holder tapered for 10 spanners, 225mm

**15,,-
EUR**



860.0866
Can holder Ø 70mm, 100mm

**8,50
EUR**



860.0867
Can holder Ø 70mm, 300mm

**15,,-
EUR**



860.0868
Pipe holder 230x70mm

**13,,-
EUR**

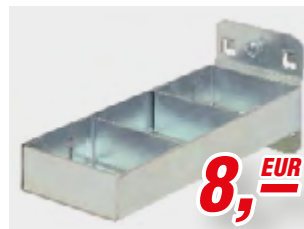

860.0847
Small component tray with partition, 150x55mm

**8,,-
EUR**



860.0848
Small component tray without partition, 150x55mm

**8,,-
EUR**



860.0869
Universal tool holder self drill, 120x70mm

**11,,-
EUR**



860.0846
Combination holder 150x55mm

**3,50
EUR**



860.0849
Spanner holder horizontal, 8 holes

**8,,-
EUR**



860.0850
Screwdriver holder, 6 holes, 150x55mm

**7,,-
EUR**



860.0851
Screwdriver holder, 12 holes, 150x55mm

**12,,-
EUR**



860.0852
Drill- and hexagon socket holder, 14 holes

**8,50
EUR**



860.0853
Drill- and hexagon socket holder, 28 holes

**17,,-
EUR**



860.0854
Saw holder, 4 holes, 150mm

**4,,-
EUR**

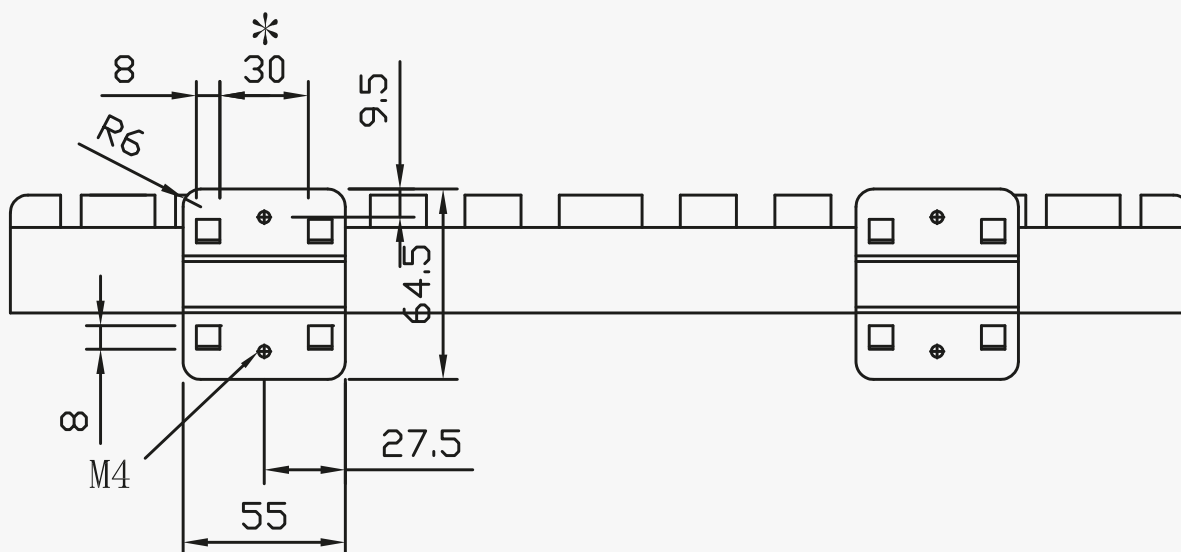

HIDE YOUR TREASURE UNDER THE HOOD

If you work with Performance Plus, you probably aren't interested in knocking off work so quickly. But when the time does come, you can cover your workshop trolley with the matching hood to protect it from dust and scratches.

**CUSTOMISED FOR
YOUR WORKSHOP TROLLEY**

**Robust protection
in a few steps**

MATCHING DESIGN

FOR ALL SIZES



-  P10
-  P10TC
-  P15
-  P20
-  P25
-  P30
-  P35
-  P45

P 10

P 15

P 20

P 25

P 30

P 35

P 40

P 45

Single inserts

Individual parts

Accessories

HOODS



873.0010
Cover for workshop trolley P10,
853x527x849 mm

19,,-



873.0015
Cover for workshop trolley P15,
845x516x848 mm

19,,-



873.0020
Cover for workshop trolley P20,
1067x646x848 mm

19,,-



873.0025
Cover for workshop trolley P25,
1040x517x849 mm

19,,-



873.0030
Cover for workshop trolley P30,
1075x657x849 mm

19,--^{EUR}



873.0035
Cover for workshop trolley P35,
1232x741x852 mm

24,--^{EUR}



873.0040
Cover for workshop trolley P40,
1701x710x829 mm

29,--^{EUR}



873.0045
Cover for workshop trolley P45,
1701x710x944 mm

29,--^{EUR}

P 10

P 15

P 20

P 25

P 30

P 35

P 40

P 45

Single inserts

Individual parts

Accessories

www.myperformanceplus.de

www.kstools.com



Your businesspartner:



KS Tools Werkzeuge - Maschinen GmbH
Seligenstädter Grund 10-12
63150 Heusenstamm
Deutschland
Tel.: +49 (0)6104 4974-0
Fax: +49 (0)6104 4974-11
E-Mail: info@kstools.de
www.myperformanceplus.de



All prices plus VAT. With the publication of this catalog, all previous prices are no longer valid.
Sale only to specialist dealers. Subject to misprints, mistakes and technical changes. Prices valid until March 31, 2022